

ÇANKAYA UNIVERSITY  
GRADUATE SCHOOL OF NATURAL AND APPLIED SCIENCES  
MATHEMATICS AND COMPUTER SCIENCE

MASTER THESIS

ON CAPUTO MODIFICATION OF THE HADAMARD FRACTIONAL  
DERIVATIVES

YUSUF YA'U GAMBO

JANUARY, 2014

**Title of the Thesis : On Caputo Modification of the Hadamard Fractional  
Derivatives**

Submitted by Yusuf Ya'u Gambo

Approval of the Graduate School of Natural and Applied Sciences, Çankaya  
University

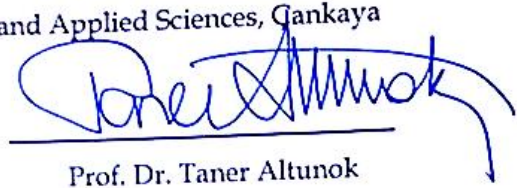

Prof. Dr. Taner Altunok

Director

I certify that this thesis satisfies all the requirements as a thesis for the degree  
of Master of Science



Prof. Dr. Billur Kaymakçalan

Head of Department

This is to certify that I have read this thesis and that in my opinion it is fully  
adequate, in scope and quality, as a thesis for the degree of Master of Science

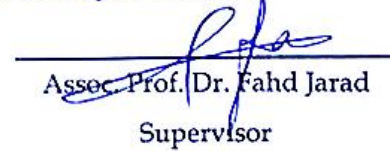

Assoc. Prof. Dr. Fahd Jarad

Supervisor

**Examination Date : 17th January, 2014**

**Examining Committee Members**

Prof. Dr. Taner Altunok (Çankaya Univ.)



Assoc. Prof. Dr. Fahd Jarad (THK Univ.)



Prof. Dr. Billur Kaymakçalan (Çankaya Univ.)

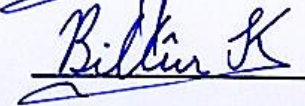

## STATEMENT OF NON-PLAGIARISM

I hereby declare that all information in this document has been obtained and presented in accordance with academic rules and ethical conduct. I also declare that, as required by these rules and conduct, I have fully cited and referenced all material and results that are not original to this work.

Name, Last Name : YUSUF TA'U GAMBBO  
Signature :   
Date : 18/01/2014

## ABSTRACT

### ON CAPUTO MODIFICATION OF THE HADAMARD FRACTIONAL DERIVATIVES

Gambo, Yusuf Ya'u

M.S.c., Department of Mathematics and Computer Science

Supervisor : Assoc. Prof. Dr. Fahd Jarad

September 2013, 54 pages

In this thesis, more properties of the Caputo modification of the Hadamard fractional derivatives are studied. The fundamental theorem of fractional calculus (FTFC) in the Caputo-Hadamard setting is presented. The theorem is then used in formulating several original results.

**Keywords:** Caputo; Hadamard fractional derivatives;  
fundamental theorem of fractional calculus.

## ÖZ

Gambo, Yusuf Ya'ü

Yükseklisans, Matematik-Bilgisayar Bölümü

Tez Yöneticisi : Assoc. Prof. Dr. Fahd Jarad

Eylül 2013, 54 sayfa

Bu tezde, Hadamard kesirli türevlerinin Caputo uyarlamasının daha fazla özellikleri incelenmiştir. Kesirli kalkülüsün temel teoreminin Caputo-Hadamard şekli sunulmuştur. Bu teorem daha sonra çeşitli özgün sonuçların formüle edilmesinde kullanılmıştır.

**Anahtar Kelimeler:** Caputo, Hadamard kesirli türevi, Kalkülüsün temel teorimi

## ACKNOWLEDGEMENT

Special thanks go to my governor, His Excellency, the Executive Governor of Kano State of Nigeria, Eng. Dr. Rabi'u Musa Kwankwaso, for his endless, patriotic and tireless support and constant encouragement.

My sincere gratitude to my supervisor, Associate Professor Dr. Fahd Jarad for his valuable cooperation and helpful suggestions.

Finally, I am particularly grateful to my parents for their endless supports.

## TABLE OF CONTENTS

STATEMENT OF NON-PLAGIARISM .....	iii
ABSTRACT .....	iv
ÖZ .....	v
ACKNOWLEDGMENT .....	vi
TABLE OF CONTENTS .....	vii
CHAPTERS:	
1. INTRODUCTION .....	1
1.1 Auxiliary Results .....	3
1.1.1 $L_p$ - Space .....	3
1.1.2 Space of absolutely continuous functions .....	5
1.1.3 Laplace and Mellin transforms .....	6
1.1.4 Gamma and beta functions .....	7
2. FRACTIONAL INTEGRALS AND FRACTIONAL DERIVATIVES .....	10
2.1 Riemann-Liouville Fractional Integrals and Fractional Derivatives .....	10
2.2 Caputo Fractional Derivatives .....	13
2.3 Hadamard Fractional Integrals and Fractional Derivatives ....	16
2.4 Applications of Fractional Derivatives .....	18
2.4.1 Viscoelasticity .....	18
2.4.2 Ultrasonic wave propagation in human cancellous bone .....	19
2.4.3 Neurophysiology of eye movements .....	20
2.4.4 Electrochemistry and tracer fluid flows .....	21

3. REVIEW OF CAPUTO-HADAMARD FRACTIONAL DERIVATIVES AND FTFC IN CAPUTO SETTINGS .....	23
3.1 Caputo-Hadamard Fractional Derivatives .....	23
3.2 FTFC in Caputo Setting .....	26
4. ON CAPUTO MODIFICATION OF THE HADAMARD FRACTIONAL DERIVATIVES .....	28
4.1 FTFC in Caputo-Hadamard Setting .....	28
4.2 Semigroup Properties of Caputo-Hadamard Operators .....	35
5. CONCLUSION .....	39
REFERENCES .....	40
APPENDIX: .....	42
CURRICULUM VITAE .....	43

## CHAPTER 1

### INTRODUCTION

The birth of fractional calculus is popularly known to take place in the late 17th century with an interesting question raised to Gottfried Wilhelm Leibniz (1646-1716) by Marquis de L'Hopital (1661-1704).

*“Can the meaning of derivatives with integer order be generalised to derivatives with non-integer orders?”*

L'Hôpital was somewhat curious about that question and replied by another question to Leibniz:

*“What if the order will be  $\frac{1}{2}$ ?”*

Leibniz in a letter dated September 30, 1695 (the exact birthdate of the fractional calculus!) replied:

*“It will lead to a paradox, from which one day useful consequences will be drawn.”*

Fractional calculus is the generalisation of differentiation and integration of integer order to arbitrary ones. As the field is as old as the usual calculus, considerable amount of researches and developments in the field are made and has been applied in the fields of science and engineering. Indeed recent developments in the field are dominated by modern applications in differential and integral equations, signal processing, fluid mechanics, viscoelasticity, mathematical biology, electrochemistry and so forth.

Perhaps the well-known fractional integral is the Riemann-Liouville type which is based on the generalisation of the usual Riemann integral  $\int_a^x f(t)dt$  [8]. Although the Riemann-Liouville fractional integrals and derivatives contributed immensely to the development of the theory of fractional calculus, it turns out that this approach has certain disadvantages when trying to model real-world phenomena with fractional differential equations. On the other hand, Riemann-Liouville fractional derivatives of a constant are, in general, not zero. Such problems were overcome with Caputo fractional derivatives.

Hadamard also proposed a fractional power of the form  $(x \frac{d}{dx})^\alpha$ . This fractional derivative is invariant with respect to dilation on the whole axis. The Hadamard approach to fractional integral was based on the generalisation of the  $n$ th integral

$$(J_{a+}^n f)(x) = \int_a^x \frac{dt_1}{t_1} \int_a^{t_1} \frac{dt_2}{t_2} \dots \int_a^{t_{n-1}} f(t_n) \frac{dt_n}{t_n} \quad (1.1)$$

Just like Riemann-Liouville, Hadamard derivative has its own disadvantages as well, one of which is the fact that the derivative of a constant is not equal to 0 in general. The authors in [8] resolved these problems by modifying the derivative into a more suitable one having physically interpretable initial conditions similar to the ones in the Caputo settings. In this thesis, we study much of this modified derivative thereby formulating some important theorems and results. The Caputo-Hadamard fractional derivatives are used to develop the FTFC and then the new results are applied in the formulation of some other theorems. As we shall see later, some interesting properties of the modified derivatives are necessary in order to formulate some important results.

The presence of the  $\delta$ - differential operator ( $\delta = x \frac{d}{dx}$ ) in the definition of Hadamard fractional derivatives could make their study uninteresting and less applicable than Riemann-Liouville and Caputo fractional derivatives. More so, this operator appears outside the integral in the definition of the Hadamard derivatives just like how the usual derivative  $D = \frac{d}{dx}$  is located outside the integral in the case of Riemann-Liouville which make the fractional derivative of a constant of these two types not equal to zero in general. The authors in [8] studied and modified the Hadamard derivatives into a more useful type using Caputo definitions.

## 1.1 Auxiliary Results

### 1.1.1 $L_p$ - Space

#### Definition 1.1

Let  $\Omega = [a, b]$ ,  $-\infty \leq a < b \leq \infty$  be a finite interval, a half-line or the whole line. We denote by  $L_p(a, b)$  ( $1 \leq p \leq \infty$ ) the set of those Lebesgue complex-valued measurable functions  $f$  on  $\Omega$  for which  $\|f\|_p < \infty$ , where

$$\|f\|_{L_p(\Omega)} = \left( \int_{\Omega} |f(x)|^p dx \right)^{\frac{1}{p}} \quad (1.2)$$

If  $p = \infty$ , the space  $L_p(\Omega)$  is defined as

$$\|f\|_{L_{\infty}(\Omega)} = \operatorname{ess\,sup}_{x \in \Omega} |f(x)| \quad (1.3)$$

Where  $\operatorname{ess\,sup} |f(x)|$  is the essential maximum of the function  $|f(x)|$ .

The weighted  $L_p$  - space with power weight, denoted by  $X_c^p(a, b)$  ( $c \in \mathbb{R}$ ,  $1 \leq p \leq \infty$ ), consists of those complex-valued Lebesgue measurable functions  $f$  on  $(a, b)$  for which  $\|f\|_{X_c^p} < \infty$ , with

$$\|f\|_{X_c^p} = \left( \int_{\Omega} |t^c f(t)|^p \frac{dt}{t} \right)^{\frac{1}{p}}, \quad 1 \leq p < \infty \quad (1.4)$$

and

$$\|f\|_{X_c^\infty} = \operatorname{ess\,sup}_{x \in \Omega} [x^c |f(x)|] \quad (1.5)$$

In particular, when  $c = \frac{1}{p}$  then the space  $X_c^p(a, b)$  coincides with the  $L_p(a, b)$  - space as  $X_{1/p}^p(a, b) = L_p(a, b)$ .

### *Properties of $L_p$ - Space*

a) The Minkowsky's inequality

$$\|f + g\|_{L_p(\Omega)} \leq \|f\|_{L_p(\Omega)} + \|g\|_{L_p(\Omega)} \quad (1.6)$$

b) Hölder's inequality

$$\int_{\Omega} |f(x)g(x)| dx \leq \|f\|_{L_p(\Omega)} \|g\|_{L_{p'}(\Omega)} \quad (1.7)$$

Where  $p' = \frac{p}{p-1}$ ,  $f(x) \in L_p(\Omega)$ ,  $g(x) \in L_{p'}(\Omega)$  and  $\frac{1}{p} + \frac{1}{p'} = 1$ .

## 1.1.2 Space of absolutely continuous functions

### **Definition 1.2**

Let  $\Omega = [a, b]$ ,  $-\infty \leq a < b \leq \infty$ , so that the interval is finite, a half-line or the whole line. A function  $\varphi: \Omega \rightarrow \mathbb{R}$  is said to be absolutely continuous on  $\Omega$  if  $\forall \varepsilon > 0 \exists \delta > 0$  such that for any finite set of pairwise non-intersecting set intervals  $[a_k, b_k] \subset \Omega$ ,  $k = 1, 2, \dots, n$  such that  $\sum_{k=1}^n (b_k - a_k) < \delta$ ,

$$\sum_{k=1}^n |\varphi(b_k) - \varphi(a_k)| < \varepsilon \quad (1.8)$$

This space is denoted by  $AC(\Omega)$ .

### **Remark 1.1**

It has been proved that the space  $AC(\Omega)$  coincides with the space of primitive of Lebesgue summable functions as

$$f(x) \in AC(\Omega) \Leftrightarrow f(x) = c + \int_a^x \varphi(t)dt, \quad \int_a^b |\varphi(t)|dt < \infty \quad (1.9)$$

**Definition 1.3**

For  $n \in \mathbb{N}$ ,  $AC^n(\Omega)$  where  $\Omega$  is an interval, is the space of functions  $\varphi(x)$  which have continuous derivatives up to order  $n - 1$  on  $\Omega$  with  $\varphi^{(n-1)}(x) \in AC(\Omega)$ . In particular,  $AC^1(\Omega) = AC(\Omega)$ .

**Lemma 1.1**

The space  $AC^n(\Omega)$  consists of those and only those functions  $f(x)$ , which are represented in the form

$$f(x) = (I_{a+}^n \varphi)(x) + \sum_{k=0}^{n-1} c_k (x - a)^k \quad (1.10)$$

Where  $\Omega$  is an interval,  $\varphi(t) \in L(a, b)$ ,  $c_k$  ( $k = 0, 1, \dots, n - 1$ ) being arbitrary constants and

$$(I_{a+}^n \varphi)(x) = \frac{1}{(n-1)!} \int_a^x \frac{\varphi(t)dt}{(x-t)^{1-n}} \quad (1.11)$$

Equation (1.9) gives

$$\varphi(t) = f^{(n)}(t), \quad c_k = \frac{f^{(k)}(a)}{k!} \quad k = 0, 1, \dots, n - 1 \quad (1.12)$$

**Definition 1.4**

The weighted  $AC^n[a, b]$  denoted by  $AC_{\delta, \mu}^n[a, b]$ , ( $n \in \mathbb{N}$ ;  $\mu \in \mathbb{R}$ ), consists of the complex-valued Lebesgue measurable function  $\varphi$  on  $(a, b)$  such that  $x^\mu \varphi(x)$  has  $\delta$ -derivative up to order  $n - 1$  on  $[a, b]$  and  $\delta^{(n-1)}[x^\mu \varphi(x)]$  is absolutely continuous on  $[a, b]$ . That is

$$AC_{\delta, \mu}^n[a, b] = \left\{ \varphi: [a, b] \rightarrow \mathbb{C}: \delta^{(n-1)}[x^\mu \varphi(x)] \in AC[a, b], \quad \mu \in \mathbb{R}, \delta = x \frac{d}{dx} \right\} \quad (1.13)$$

Where

$$\delta = xD = x \frac{d}{dx} \quad (1.14)$$

is called  $\delta$ -derivative.

In particular, when  $\mu = 0$  then the weighted space is defined as

$$AC_{\delta,0}^n[a, b] = AC_{\delta}^n[a, b] = \left\{ \varphi: [a, b] \rightarrow \mathbb{C}: \delta^{(n-1)}[\varphi(x)] \in AC[a, b] \delta = x \frac{d}{dx} \right\} \quad (1.15)$$

Additionally, if  $n = 1$ , then the space  $AC_{\delta}^1[a, b]$  coincides with  $AC[a, b]$ .

### Lemma 1.2

Let  $0 < a < b < \infty$ ,  $n \in \mathbb{N}$  and  $\mu \in \mathbb{R}$ . The space  $AC_{\delta,\mu}^n[a, b]$  consists of those and only those functions  $f(x)$  which are represented in the form

$$f(x) = x^{\mu} \left[ \frac{1}{(n-1)!} \int_a^x \left( \log \frac{x}{t} \right)^{n-1} \varphi(t) \frac{dt}{t} + \sum_{k=0}^{n-1} d_k \left( \log \frac{x}{a} \right)^k \right] \quad (1.16)$$

Where  $\varphi(t) \in L(a, b)$  and  $d_k$  ( $k = 0, 1, \dots, n-1$ ) being arbitrary constants. It is clear that  $AC_{\delta}^n[a, b]$  if and only if

$$f(x) = \frac{1}{(n-1)!} \int_a^x \left( \log \frac{x}{t} \right)^{n-1} \varphi(t) \frac{dt}{t} + \sum_{k=0}^{n-1} d_k \left( \log \frac{x}{a} \right)^k \quad (1.17)$$

It follows from equation (1.15) that

$$\varphi(t) = f^{(n)}(t), \quad d_k = \frac{f^{(k)}(a)}{k!}, \quad k = 0, 1, \dots, n-1 \quad (1.18)$$

### 1.1.3 Laplace and Mellin transforms

#### Definition 1.5 (Laplace transform)

Let  $t \in \mathbb{R}^+$ . The Laplace transform of a function  $\varphi(t)$  is given by

$$(\mathcal{L}\varphi)(s) = \mathcal{L}[\varphi(t)](s) = \tilde{\varphi}(s) = \int_0^{\infty} e^{-st} \varphi(t) dt \quad s \in \mathbb{C} \quad (1.19)$$

The inverse Laplace transform is defined for  $x \in \mathbb{R}^+$  by

$$(\mathcal{L}^{-1}g)(x) = \mathcal{L}^{-1}[g(s)](x) = \frac{1}{2\pi i} \int_{\gamma-i\infty}^{\gamma+i\infty} e^{sx} g(s) ds \quad \gamma = \Re(s) > \sigma_{\varphi} \quad (1.20)$$

Where  $\sigma_\varphi$  is the abscissa of convergence which is defined as the infimum of values  $s$  for which the Laplace integral in (1.18) converges.

**Definition 1.6**

Let  $x, h \in \mathbb{R}$ . The translation  $\tau_h$  and dilation  $\Pi_\lambda$  operators are defined respectively by

$$(\tau_h\varphi)(x) = \varphi(x - h) \quad x, h \in \mathbb{R} \quad (1.21)$$

$$(\Pi_\lambda\varphi)(x) = \varphi(\lambda x) \quad x \in \mathbb{R}, \lambda > 0 \quad (1.22)$$

**Properties of Laplace transform**

$$(\mathcal{L}\tau_h\varphi)(p) = e^{-ph}(\mathcal{L}\varphi)(p) \quad h \in \mathbb{R} \quad (1.23)$$

$$(\mathcal{L}\Pi_\lambda\varphi)(p) = \frac{1}{\lambda} \mathcal{L}\left(\frac{p}{\lambda}\right) \quad \lambda \in \mathbb{R}^+ \quad (1.24)$$

$$\mathcal{L}[e^{-at}\varphi(t)](p) = (\tau_{-a}\mathcal{L})(p) \equiv \mathcal{L}(p + a) \quad a \in \mathbb{C} \quad (1.25)$$

$$\mathcal{L}[D^k\varphi(t)](p) = p^k(\mathcal{L}\varphi)(p) \quad k \in \mathbb{N} \quad (1.26)$$

$$D^k(\mathcal{L}\varphi)(s) = (-1)^k \mathcal{L}[t^k\varphi(t)](s) \quad k \in \mathbb{N} \quad (1.27)$$

**Definition 1.7 (Mellin transform)**

The Mellin transform of a function  $\varphi(t)$  of a real variable  $t \in \mathbb{R}^+$  is define by

$$(\mathcal{M}\varphi)(s) = \mathcal{M}[\varphi(t)](s) = \varphi^*(s) = \int_0^\infty t^{s-1}\varphi(t)dt \quad s \in \mathbb{C} \quad (1.28)$$

and the inverse is

$$(\mathcal{M}^{-1}g)(x) = \mathcal{M}^{-1}[g(s)](x) = \frac{1}{2\pi i} \int_{\gamma-i\infty}^{\gamma+i\infty} x^{-s}g(s)ds \quad \gamma = \Re(s) \quad (1.29)$$

**1.1.4 Gamma and beta functions**

The gamma function  $\Gamma(z)$  is defined by the integral

$$\Gamma(z) = \int_0^\infty t^{z-1}e^{-t}dt \quad \Re(z) > 0 \quad (1.30)$$

It can be observed that the gamma function is the Mellin transform of the exponential function

$$\mathcal{M}[e^{-t}](z) = \Gamma(z) \quad \Re(z) > 0 \quad (1.31)$$

## *Properties of Gamma Function*

An elementary property:

$$\Gamma(1) = 0! = 1 \quad (1.32)$$

Reduction formula:

$$\Gamma(z + 1) = z\Gamma(z) \quad \Re(z) > 0 \quad (1.33)$$

Pochhammer function:

$$\Gamma(z) = \frac{\Gamma(z + n)}{(z)_n} \quad \Re(z) > -n, n \in \mathbb{N}, z \notin \mathbb{Z}_0^- := \{0, -1, -2, \dots\} \quad (1.34)$$

on the half-plane  $\Re(z) \leq 0$

where  $(z)_n$  is known as the Pochhammer symbol (raising factorial or Pochhammer function), defined by

$$(z)_0 = 1, (z)_n = z(z + 1) \dots (z + n - 1) \quad n \in \mathbb{N}, z \in \mathbb{C} \quad (1.35)$$

Using equations (1.31) to (1.34) we obtain

$$\Gamma(z + 1) = \Gamma(1)(1)_n = n! \quad n \in \mathbb{N}_0 = \{0, 1, 2, \dots\} \quad (1.36)$$

Equation (1.33) shows that gamma function is analytic everywhere in the complex plane except at  $z = 0, -1, -2, \dots$  where  $\Gamma(z)$  has simple poles and is defined by the asymptotic formula

$$\Gamma(z) = \frac{(-1)^k}{z + k} [1 + O(z + k)] \quad z \rightarrow -k, \quad k \in \mathbb{N}_0 \quad (1.37)$$

Functional equation:

$$\Gamma(z) \Gamma(1 - z) = \frac{\pi}{\sin \pi z} \quad z \notin \mathbb{Z}_0^-, \quad 0 < \Re(z) < 1,$$

$$\Gamma\left(\frac{1}{2}\right) = \sqrt{\pi} \quad (1.38)$$

Legendre duplication formula:

$$\Gamma(2z) = \frac{2^{2z-1}}{\sqrt{\pi}} \Gamma(z) \Gamma\left(z + \frac{1}{2}\right) \quad z \in \mathbb{C} \quad (1.39)$$

Gauss-Legendre multiplication theorem:

$$\Gamma(mz) = \frac{2^{mz-1}}{(2\pi)^{\frac{m-1}{2}}} \prod_{k=0}^{m-1} \Gamma\left(z + \frac{k}{m}\right) \quad z \in \mathbb{C}, m \in \mathbb{N} \setminus \{1\} \quad (1.40)$$

Stirling asymptotic formula:

$$\Gamma(z) = (2\pi)^{1/2} z^{z-1/2} e^{-z} \left[ 1 + O\left(\frac{1}{z}\right) \right] \quad |\arg(z)| < \pi, |z| \rightarrow \infty \quad (1.41)$$

Euler psi function:

$$\psi(z) = \frac{d}{dz} \log \Gamma(z) = \frac{\Gamma'(z)}{\Gamma(z)} \quad z \in \mathbb{C} \quad (1.42)$$

with the property

$$\psi(z+m) = \psi(z) + \sum_{k=0}^{m-1} \frac{1}{z+k} \quad z \in \mathbb{C}, m \in \mathbb{N} \quad (1.43)$$

and

$$\psi(z+1) = \psi(z) + \frac{1}{z} \quad m = 1 \quad (1.44)$$

The beta function  $B(z, w)$  is defined by

$$B(z, w) = \int_0^1 t^{z-1} (1-t)^{w-1} dt \quad \Re(z) > 0, \Re(w) > 0 \quad (1.45)$$

The connection of gamma function with the beta function is given by the formula

$$B(z, w) = \frac{\Gamma(z)\Gamma(w)}{\Gamma(z+w)} \quad z, w \notin \mathbb{Z}_0^- \quad (1.46)$$

The incomplete gamma functions  $\gamma(z, w)$  and  $\Gamma(z, w)$  are defined for  $z, w \in \mathbb{C}$  by

$$\gamma(z, w) = \int_0^w t^{z-1} e^{-t} dt \quad \Re(z) > 0 \quad (1.47)$$

$$\Gamma(z, w) = \int_w^\infty t^{z-1} e^{-t} dt \quad (1.48)$$

$$\gamma(z, \infty) = \Gamma(z, 0) = \Gamma(z) = \gamma(z, w) + \Gamma(z, w) \quad \Re(z) > 0 \quad (1.49)$$

## CHAPTER 2

### FRACTIONAL INTEGRALS AND FRACTIONAL DERIVATIVES

#### 2.1 Riemann-Liouville Fractional Integrals and Fractional Derivatives

Let  $\Omega = [a, b]$  be a finite interval on the real axis  $\mathbb{R}$ .

##### Definition 2.1

The left-sided and the right sided Riemann-Liouville fractional integrals of order  $\alpha \in \mathbb{C}$ ,  $\Re(\alpha) > 0$  are defined respectively by

$$(I_{a+}^{\alpha}\varphi)(x) = \frac{1}{\Gamma(\alpha)} \int_a^x \frac{\varphi(t)dt}{(x-t)^{1-\alpha}} \quad x > a, \Re(\alpha) > 0 \quad (2.1)$$

$$(I_{b-}^{\alpha}\varphi)(x) = \frac{1}{\Gamma(\alpha)} \int_x^b \frac{\varphi(t)dt}{(t-x)^{1-\alpha}} \quad x < b, \Re(\alpha) > 0 \quad (2.2)$$

##### Definition 2.2

The left-sided and right-sided Riemann-Liouville fractional derivatives of order  $\alpha \in \mathbb{C}$ ,  $\Re(\alpha) \geq 0$

$$\begin{aligned} (D_{a+}^{\alpha}\varphi)(x) &= \left(\frac{d}{dx}\right)^n (I_{a+}^{n-\alpha}\varphi)(x) \\ &= \frac{1}{\Gamma(n-\alpha)} \left(\frac{d}{dx}\right)^n \int_a^x \frac{\varphi(t)dt}{(x-t)^{\alpha-n+1}} \quad x > a, n = [\Re(\alpha) + 1] \end{aligned} \quad (2.3)$$

$$(D_{b-}^{\alpha}\varphi)(x) = \left(-\frac{d}{dx}\right)^n (I_{b-}^{n-\alpha}\varphi)(x) = \frac{1}{\Gamma(n-\alpha)} \left(-\frac{d}{dx}\right)^n \int_x^b \frac{\varphi(t)dt}{(t-x)^{\alpha-n+1}} \quad x < b, n = [\Re(\alpha) + 1] \quad (2.4)$$

Where  $[\Re(\alpha)]$  is the integral part of  $\Re(\alpha)$ .

For  $\alpha = n \in \mathbb{N}_0 = \{0, 1, 2, \dots\}$ ,

$$(D_{a+}^0 \varphi)(x) = (D_{b-}^0 \varphi)(x) = \varphi(x), \quad (D_{a+}^n \varphi)(x) = \varphi^{(n)}(x),$$

$$(D_{b-}^n \varphi)(x) = (-1)^n \varphi^{(n)}(x) \quad n \in \mathbb{N} \quad (2.5)$$

For  $0 < \Re(\alpha) < 1$

$$(D_{a+}^\alpha \varphi)(x) = \frac{1}{\Gamma(1-\alpha)} \frac{d}{dx} \int_a^x \frac{\varphi(t) dt}{(x-t)^{\alpha - [\Re(\alpha)]}} \quad x > a, \quad (2.6)$$

$$(D_{b-}^\alpha \varphi)(x) = -\frac{1}{\Gamma(1-\alpha)} \frac{d}{dx} \int_x^b \frac{\varphi(t) dt}{(t-x)^{\alpha - [\Re(\alpha)]}} \quad x < b, \quad (2.7)$$

For  $\alpha \in \mathbb{R}^+$ , we have

$$(D_{a+}^\alpha \varphi)(x) = \frac{1}{\Gamma(n-\alpha)} \left( \frac{d}{dx} \right)^n \int_a^x \frac{\varphi(t) dt}{(x-t)^{\alpha-n+1}} \quad x > a, \quad n = [\alpha] + 1 \quad (2.8)$$

$$(D_{b-}^\alpha \varphi)(x) = \frac{1}{\Gamma(n-\alpha)} \left( -\frac{d}{dx} \right)^n \int_x^b \frac{\varphi(t) dt}{(t-x)^{\alpha-n+1}} \quad x < b, \quad n = [\alpha] + 1 \quad (2.9)$$

$$(D_{a+}^\alpha \varphi)(x) = \frac{1}{\Gamma(1-\alpha)} \frac{d}{dx} \int_a^x \frac{\varphi(t) dt}{(x-t)^\alpha} \quad 0 < \alpha < 1; x > a, \quad (2.10)$$

$$(D_{b-}^\alpha \varphi)(x) = -\frac{1}{\Gamma(1-\alpha)} \frac{d}{dx} \int_x^b \frac{\varphi(t) dt}{(t-x)^\alpha} \quad 0 < \alpha < 1; x < b, \quad (2.11)$$

For  $[\Re(\alpha)] = 0$  ( $\alpha \neq 0$ ), we have derivatives of a purely imaginary order.

$$(D_{a+}^{i\theta} \varphi)(x) = \frac{1}{\Gamma(1-i\theta)} \frac{d}{dx} \int_a^x \frac{\varphi(t) dt}{(x-t)^{i\theta}} \quad \theta \in \mathbb{R} \setminus \{0\}; x > a \quad (2.12)$$

$$(D_{b-}^{i\theta} \varphi)(x) = -\frac{1}{\Gamma(1-i\theta)} \frac{d}{dx} \int_x^b \frac{\varphi(t) dt}{(t-x)^{i\theta}} \quad \theta \in \mathbb{R} \setminus \{0\}; x < b \quad (2.13)$$

**The power functions  $(x-a)^{\beta-1}, (b-x)^{\beta-1}$**

Let  $\Re(\alpha) \geq 0$  and  $\beta \in \mathbb{C}$  with  $\Re(\beta) > 0$ , then the following properties are evident:

$$(I_{a+}^\alpha (t-a)^{\beta-1})(x) = \frac{\Gamma(\beta)}{\Gamma(\beta+\alpha)} (x-a)^{\beta+\alpha-1} \quad \Re(\alpha) > 0 \quad (2.14)$$

$$(D_{a+}^\alpha (t-a)^{\beta-1})(x) = \frac{\Gamma(\beta)}{\Gamma(\beta-\alpha)} (x-a)^{\beta-\alpha-1} \quad \Re(\alpha) \geq 0 \quad (2.15)$$

$$(I_{b-}^{\alpha}(b-t)^{\beta-1})(x) = \frac{\Gamma(\beta)}{\Gamma(\beta+\alpha)}(b-x)^{\beta+\alpha-1} \quad \Re(\alpha) > 0 \quad (2.16)$$

$$(D_{b-}^{\alpha}(b-t)^{\beta-1})(x) = \frac{\Gamma(\beta)}{\Gamma(\beta-\alpha)}(b-x)^{\beta-\alpha-1} \quad \Re(\alpha) \geq 0 \quad (2.17)$$

From equations (2.15) and (2.17) or otherwise, it can be verified that if  $\beta = 1$  and  $\Re(\alpha) \geq 0$ , then the Riemann-Liouville fractional derivatives of a constant are generally not zero.

$$(D_{a+}^{\alpha}1)(x) = \frac{(x-a)^{-\alpha}}{\Gamma(1-\alpha)}, \quad (D_{b-}^{\alpha}1)(x) = \frac{(b-x)^{-\alpha}}{\Gamma(1-\alpha)} \quad 0 < \Re(\alpha) < 1 \quad (2.18)$$

### Lemma 2.1

If  $\Re(\alpha) > 0$  and  $\Re(\beta) > 0$ , then the following relations are satisfied at almost every point  $x \in [a, b]$  for  $f(x) \in L_p(a, b)$   $1 \leq p \leq \infty$ .

$$(I_{a+}^{\alpha}I_{a+}^{\beta}\varphi)(x) = (I_{a+}^{\alpha+\beta}\varphi)(x), \quad (I_{b-}^{\alpha}I_{b-}^{\beta}\varphi)(x) = (I_{b-}^{\alpha+\beta}\varphi)(x) \quad (2.19)$$

Moreover, equation (2.19) hold at any point of  $[a, b]$  if  $\alpha + \beta > 1$ .

### Definition 2.3

The left-sided and right-sided fractional integrals and derivatives on the half-axis  $\mathbb{R}^+$  are respectively defined by

$$(I_{0+}^{\alpha}\varphi)(x) = \frac{1}{\Gamma(\alpha)} \int_0^x \frac{\varphi(t)dt}{(x-t)^{1-\alpha}} \quad x > 0, \quad \Re(\alpha) > 0 \quad (2.20)$$

$$(I_{-}^{\alpha}\varphi)(x) = \frac{1}{\Gamma(\alpha)} \int_x^{\infty} \frac{\varphi(t)dt}{(t-x)^{1-\alpha}} \quad x > 0, \quad \Re(\alpha) > 0 \quad (2.21)$$

$$\begin{aligned} (D_{0+}^{\alpha}\varphi)(x) &= \left(\frac{d}{dx}\right)^n (I_{0+}^{n-\alpha}\varphi)(x) \\ &= \frac{1}{\Gamma(n-\alpha)} \left(\frac{d}{dx}\right)^n \int_0^x \frac{\varphi(t)dt}{(x-t)^{\alpha-n+1}} \end{aligned} \quad (2.22)$$

$$(D_{-}^{\alpha}\varphi)(x) = \left(-\frac{d}{dx}\right)^n (I_{-}^{n-\alpha}\varphi)(x) = \frac{1}{\Gamma(n-\alpha)} \left(-\frac{d}{dx}\right)^n \int_x^{\infty} \frac{\varphi(t)dt}{(t-x)^{\alpha-n+1}} \quad (2.23)$$

Where  $n = [\Re(\alpha) + 1]$ ,  $\Re(\alpha) \geq 0$  and  $x > 0$ .

## 2.2 Caputo Fractional Derivatives

Although Riemann-Liouville fractional derivatives and integrals are perhaps the most commonly used approach and have contributed significantly to the development of the field of fractional calculus, however, it turns out that they have certain drawbacks in describing real-world phenomena with fractional differential equations. Caputo's approach is highly advantageous for such task.

### Definition 2.4

Let  $\Omega = [a, b]$  be a finite interval of the real line  $\mathbb{R}$ . Let  $(D_{a+}^{\alpha}\varphi)(x)$  and  $(D_{b-}^{\alpha}\varphi)(x)$  be the Riemann-Liouville fractional derivatives of order  $\alpha \in \mathbb{C}$  with  $\Re(\alpha) \geq 0$ . The Caputo left-sided and right-sided fractional derivatives of order  $\alpha$  are defined through Riemann-Liouville fractional derivatives respectively by

$$({}^C D_{a+}^{\alpha}\varphi)(x) = \left( D_{a+}^{\alpha} \left[ \varphi(t) - \sum_{k=0}^{n-1} \frac{\varphi^{(k)}(a)}{k!} (t-a)^k \right] \right)(x) \quad (2.24)$$

$$({}^C D_{b-}^{\alpha}\varphi)(x) = \left( D_{b-}^{\alpha} \left[ \varphi(t) - \sum_{k=0}^{n-1} \frac{\varphi^{(k)}(b)}{k!} (b-t)^k \right] \right)(x) \quad (2.25)$$

Where  $n = [\Re(\alpha)] + 1$  for  $\alpha \notin \mathbb{N}_0$ ,  $n = \alpha$  for  $\alpha \in \mathbb{N}_0$ .

For  $0 < \Re(\alpha) < 1$ , equations (2.49) and (2.50) becomes

$$({}^C D_{a+}^{\alpha}\varphi)(x) = (D_{a+}^{\alpha}[\varphi(t) - \varphi(a)])(x) \quad (2.26)$$

$$({}^C D_{b-}^{\alpha}\varphi)(x) = (D_{b-}^{\alpha}[\varphi(t) - \varphi(b)])(x) \quad (2.27)$$

Further, if  $\alpha \notin \mathbb{N}_0$  and  $n = [\Re(\alpha) + 1]$ , then

$$({}^C D_{a+}^{\alpha}\varphi)(x) = (D_{a+}^{\alpha}\varphi)(x) - \sum_{k=0}^{n-1} \frac{\varphi^{(k)}(a)}{\Gamma(k - \alpha + 1)} (x-a)^{k-\alpha} \quad (2.28)$$

$$({}^C D_{b-}^{\alpha}\varphi)(x) = (D_{b-}^{\alpha}\varphi)(x) - \sum_{k=0}^{n-1} \frac{\varphi^{(k)}(b)}{\Gamma(k - \alpha + 1)} (b-x)^{k-\alpha} \quad (2.29)$$

For  $0 < \Re(\alpha) < 1$ , we have

$$({}^C D_{a+}^{\alpha}\varphi)(x) = (D_{a+}^{\alpha}\varphi)(x) - \frac{\varphi(a)(x-a)^{-\alpha}}{\Gamma(1-\alpha)} \quad (2.30)$$

$$({}^c D_{b-}^\alpha \varphi)(x) = (D_{b-}^\alpha \varphi)(x) - \frac{\varphi(b)(b-x)^{-\alpha}}{\Gamma(1-\alpha)} \quad (2.31)$$

**Definition 2.5 (Classical Definition)**

Let  $n \geq 0$  and that  $f$  is such that  $D_a^n[f - T_{m-1}[f; a]]$  exists, where  $m = [n]$ . Then we define Caputo differential operator of order  $n$  by

$$D_{*a}^n f = D_a^n[f - T_{m-1}[f; a]] \quad (2.32)$$

Where  $T_{m-1}[f; a]$  denotes the Taylor polynomial of degree  $m - 1$  for the function  $f$ , centred at  $a$ .

**Theorem 2.1**

Let  $\Re(\alpha) \geq 0$ . Let  $n = [\Re(\alpha)] + 1$  for  $\alpha \notin \mathbb{N}_0$  and  $n = \alpha$  for  $\alpha \in \mathbb{N}_0$ . If  $\varphi(x) \in AC^n[a, b]$ , then the Caputo fractional derivatives exist almost everywhere on  $[a, b]$ .

a) If  $\alpha \notin \mathbb{N}_0$ , then

$$({}^c D_{a+}^\alpha \varphi)(x) = \frac{1}{\Gamma(n-\alpha)} \int_a^x \frac{\varphi^{(n)}(t) dt}{(x-t)^{\alpha-n+1}} = (I_{a+}^{n-\alpha} D^n \varphi)(x) \quad (2.33)$$

$$({}^c D_{b-}^\alpha \varphi)(x) = \frac{(-1)^n}{\Gamma(n-\alpha)} \int_x^b \frac{\varphi^{(n)}(t) dt}{(t-x)^{\alpha-n+1}} = (-1)^n (I_{b-}^{n-\alpha} D^n \varphi)(x) \quad (2.34)$$

For  $0 < \Re(\alpha) < 1$  and  $\varphi(x) \in AC[a, b]$

$$({}^c D_{a+}^\alpha \varphi)(x) = \frac{1}{\Gamma(1-\alpha)} \int_a^x \frac{\varphi'(t) dt}{(x-t)^\alpha} = (I_{a+}^{1-\alpha} D \varphi)(x) \quad (2.35)$$

$$({}^c D_{b-}^\alpha \varphi)(x) = -\frac{1}{\Gamma(1-\alpha)} \int_x^b \frac{\varphi'(t) dt}{(t-x)^\alpha} = -(I_{b-}^{1-\alpha} D \varphi)(x) \quad (2.36)$$

b) If  $\alpha = n \in \mathbb{N}_0$ , then

$$({}^c D_{a+}^n \varphi)(x) = \varphi^{(n)}(x), ({}^c D_{b-}^n \varphi)(x) = (-1)^n \varphi^{(n)}(x), \quad n \in \mathbb{N} \quad (2.37)$$

**Property 2.1**

Let  $\Re(\alpha) > 0$  and  $n = [\Re(\alpha) + 1]$  for  $\alpha \notin \mathbb{N}_0$  and  $n = \alpha$  for  $\alpha \in \mathbb{N}_0$ . Let  $\Re(\beta) > 0$ , then the following relations hold:

$$({}^c D_{a+}^\alpha (t-a)^{\beta-1})(x) = \frac{\Gamma(\beta)}{\Gamma(\beta-\alpha)} (x-a)^{\beta-1} \quad \Re(\beta) > n \quad (2.38)$$

$$({}^c D_{b-}^\alpha (b-t)^{\beta-1})(x) = \frac{\Gamma(\beta)}{\Gamma(\beta-\alpha)} (b-x)^{\beta-1} \quad \Re(\beta) > n \quad (2.39)$$

$$({}^c D_{a+}^\alpha (t-a)^k)(x) = 0, \quad ({}^c D_{b-}^\alpha (b-t)^k)(x) = 0 \quad k = 0, 1, \dots, n-1 \quad (2.40)$$

In particular, unlike with Riemann-Liouville fractional derivatives, the Caputo derivatives of a constant are zero. That is

$$({}^c D_{a+}^\alpha 1)(x) = 0, \quad ({}^c D_{b-}^\alpha 1)(x) = 0 \quad (2.41)$$

### Definition 2.6

The Caputo fractional derivative of order  $\alpha \in \mathbb{C}$  (with  $\Re(\alpha) > 0$  and  $\alpha \notin \mathbb{N}$ ) on the half-axis  $\mathbb{R}^+$  and on the whole axis  $\mathbb{R}$  are defined respectively as

$$({}^c D_{0+}^\alpha \varphi)(x) = \frac{1}{\Gamma(n-\alpha)} \int_0^x \frac{\varphi^{(n)}(t) dt}{(x-t)^{\alpha-n+1}} \quad x \in \mathbb{R}^+ \quad (2.42)$$

$$({}^c D_-^\alpha \varphi)(x) = \frac{(-1)^n}{\Gamma(n-\alpha)} \int_x^\infty \frac{\varphi^{(n)}(t) dt}{(t-x)^{\alpha-n+1}} \quad x \in \mathbb{R}^+ \quad (2.43)$$

and

$$({}^c D_+^\alpha \varphi)(x) = \frac{1}{\Gamma(n-\alpha)} \int_{-\infty}^x \frac{\varphi^{(n)}(t) dt}{(x-t)^{\alpha-n+1}} \quad x \in \mathbb{R} \quad (2.44)$$

$$({}^c D_-^\alpha \varphi)(x) = \frac{(-1)^n}{\Gamma(n-\alpha)} \int_x^\infty \frac{\varphi^{(n)}(t) dt}{(t-x)^{\alpha-n+1}} \quad x \in \mathbb{R} \quad (2.45)$$

In particular,  $0 < \Re(\alpha) < 1$  equations (2.67) to (2.70) take the following form

$$({}^c D_{0+}^\alpha \varphi)(x) = \frac{1}{\Gamma(1-\alpha)} \int_0^x \frac{\varphi'(t) dt}{(x-t)^\alpha} \quad x \in \mathbb{R}^+ \quad (2.46)$$

$$({}^c D_-^\alpha \varphi)(x) = -\frac{1}{\Gamma(1-\alpha)} \int_x^\infty \frac{\varphi'(t) dt}{(t-x)^\alpha} \quad x \in \mathbb{R}^+ \quad (2.47)$$

and

$$({}^c D_+^\alpha \varphi)(x) = \frac{1}{\Gamma(1-\alpha)} \int_{-\infty}^x \frac{\varphi'(t) dt}{(x-t)^\alpha} \quad x \in \mathbb{R} \quad (2.48)$$

$$({}^c D_-^\alpha \varphi)(x) = -\frac{1}{\Gamma(1-\alpha)} \int_x^\infty \frac{\varphi'(t) dt}{(t-x)^\alpha} \quad x \in \mathbb{R} \quad (2.49)$$

### 2.3 Hadamard Fractional Integrals and Fractional Derivatives

#### Definition 2.7

Let  $(a, b)$ ,  $0 \leq a \leq b \leq \infty$  be finite or infinite interval of the half-axis  $\mathbb{R}^+$ . Let  $\Re(\alpha) > 0$  and  $\mu \in \mathbb{C}$ . The Hadamard fractional integrals of order  $\alpha \in \mathbb{C}$  are defined by

$$(\mathcal{J}_{a+}^{\alpha} \varphi)(x) = \frac{1}{\Gamma(\alpha)} \int_a^x \left(\log \frac{x}{t}\right)^{\alpha-1} \frac{\varphi(t) dt}{t} \quad a < x < b \quad (2.50)$$

$$(\mathcal{J}_{b-}^{\alpha} \varphi)(x) = \frac{1}{\Gamma(\alpha)} \int_x^b \left(\log \frac{t}{x}\right)^{\alpha-1} \frac{\varphi(t) dt}{t} \quad a < x < b \quad (2.51)$$

When  $a = 0$  and  $b = \infty$ , then we have

$$(\mathcal{J}_{0+}^{\alpha} \varphi)(x) = \frac{1}{\Gamma(\alpha)} \int_0^x \left(\log \frac{x}{t}\right)^{\alpha-1} \frac{\varphi(t) dt}{t} \quad x > 0 \quad (2.52)$$

$$(\mathcal{J}_{-}^{\alpha} \varphi)(x) = \frac{1}{\Gamma(\alpha)} \int_x^{\infty} \left(\log \frac{t}{x}\right)^{\alpha-1} \frac{\varphi(t) dt}{t} \quad x > 0 \quad (2.53)$$

#### Definition 2.8

The Hadamard-type fractional integrals of order  $\alpha \in \mathbb{C}$  with those conditions in definition 3.7, are defined by

$$(\mathcal{J}_{0+, \mu}^{\alpha} \varphi)(x) = \frac{1}{\Gamma(\alpha)} \int_0^x \left(\frac{t}{x}\right)^{\mu} \left(\log \frac{x}{t}\right)^{\alpha-1} \frac{\varphi(t) dt}{t} \quad x > 0 \quad (2.54)$$

$$(\mathcal{J}_{-, \mu}^{\alpha} \varphi)(x) = \frac{1}{\Gamma(\alpha)} \int_x^{\infty} \left(\frac{x}{t}\right)^{\mu} \left(\log \frac{t}{x}\right)^{\alpha-1} \frac{\varphi(t) dt}{t} \quad x > 0 \quad (2.55)$$

#### Definition 2.9

The left-sided and right-sided Hadamard fractional derivatives of order  $\alpha \in \mathbb{C}$  with  $\Re(\alpha) \geq 0$  on  $(a, b)$  are defined by

$$(\mathcal{D}_{a+}^{\alpha} \varphi)(x) = \delta^n (\mathcal{J}_{a+}^{n-\alpha} \varphi)(x) = \left(x \frac{d}{dx}\right)^n \frac{1}{\Gamma(n-\alpha)} \int_a^x \left(\log \frac{x}{t}\right)^{n-\alpha-1} \frac{\varphi(t) dt}{t} \quad a < x < b \quad (2.56)$$

$$\begin{aligned} (\mathcal{D}_{b-}^{\alpha} \varphi)(x) &= (-\delta)^n (\mathcal{J}_{b-}^{n-\alpha} \varphi)(x) \\ &= \left(-x \frac{d}{dx}\right)^n \frac{1}{\Gamma(n-\alpha)} \int_x^b \left(\log \frac{t}{x}\right)^{n-\alpha-1} \frac{\varphi(t) dt}{t} \quad a < x < b \end{aligned}$$

(2.57)

Where  $\delta = xD$ ,  $D = \frac{d}{dx}$ ,  $n = [\Re(\alpha) + 1]$ .

When  $a = 0$  and  $b = \infty$ , then

$$(\mathfrak{D}_{0+}^{\alpha}\varphi)(x) = \delta^n (J_{0+}^{n-\alpha}\varphi)(x) \quad x > 0 \quad (2.58)$$

$$(\mathfrak{D}_{-}^{\alpha}\varphi)(x) = (-\delta)^n (J_{-}^{n-\alpha}\varphi)(x) \quad x > 0 \quad (2.59)$$

### Definition 2.10

The Hadamard-type fractional derivatives of order  $\alpha \in \mathbb{C}$  with  $\mu \in \mathbb{C}$  and  $\Re(\alpha) \geq 0$  are defined by

$$(\mathfrak{D}_{0+,\mu}^{\alpha}\varphi)(x) = x^{-\mu} \delta^n x^{\mu} (J_{0+,\mu}^{n-\alpha}\varphi)(x) \quad (2.60)$$

$$(\mathfrak{D}_{-,\mu}^{\alpha}\varphi)(x) = x^{\mu} (-\delta)^n x^{-\mu} (J_{-,\mu}^{n-\alpha}\varphi)(x) \quad (2.61)$$

Where  $n = [\Re(\alpha) + 1]$ .

When  $\alpha = m \in \mathbb{N}$ , then

$$(\mathfrak{D}_{0+}^m\varphi)(x) = (\delta^m\varphi)(x) \text{ and } (\mathfrak{D}_{-}^m\varphi)(x) = (-1)^m (\delta^m\varphi)(x) \quad (2.62)$$

With  $0 \leq a < x < b \leq \infty$ ,  $x > 0$ , and

$$(\mathfrak{D}_{0+,\mu}^m\varphi)(x) = x^{\mu} \delta^m x^{-\mu} \varphi(x) \text{ and}$$

$$(\mathfrak{D}_{-,\mu}^m\varphi)(x) = x^{-\mu} (-\delta)^m x^{\mu} \varphi(x) \quad (2.63)$$

### Property 2.2

If  $\Re(\alpha) > 0$ ,  $\Re(\beta) > 0$  and  $0 < a < b < \infty$ , then

$$\left( J_{a+}^{\alpha} \left( \log \frac{t}{a} \right)^{\beta-1} \right) (x) = \frac{\Gamma(\beta)}{\Gamma(\beta + \alpha)} \left( \log \frac{x}{a} \right)^{\beta+\alpha-1} \quad (2.64)$$

$$\left( \mathfrak{D}_{a+}^{\alpha} \left( \log \frac{t}{a} \right)^{\beta-1} \right) (x) = \frac{\Gamma(\beta)}{\Gamma(\beta - \alpha)} \left( \log \frac{x}{a} \right)^{\beta-\alpha-1} \quad (2.65)$$

$$\left( J_{b-}^{\alpha} \left( \log \frac{b}{t} \right)^{\beta-1} \right) (x) = \frac{\Gamma(\beta)}{\Gamma(\beta + \alpha)} \left( \log \frac{b}{x} \right)^{\beta+\alpha-1} \quad (2.66)$$

$$\left( \mathfrak{D}_{b-}^{\alpha} \left( \log \frac{b}{t} \right)^{\beta-1} \right) (x) = \frac{\Gamma(\beta)}{\Gamma(\beta - \alpha)} \left( \log \frac{b}{x} \right)^{\beta-\alpha-1} \quad (2.67)$$

In particular, if  $\beta = 1$  and  $\Re(\beta) \geq 0$ , then the Hadamard fractional derivatives of a constant, are not generally zero.

$$(\mathfrak{D}_{a+}^{\alpha} 1)(x) = \frac{1}{\Gamma(1-\alpha)} \left(\log \frac{x}{a}\right)^{-\alpha} \quad \text{and} \quad (\mathfrak{D}_{b-}^{\alpha} 1)(x) = \frac{1}{\Gamma(1-\alpha)} \left(\log \frac{b}{x}\right)^{-\alpha}$$

where  $0 < \Re(\alpha) < 1$  (2.68)

### Property 2.3

Let  $\alpha, \beta \in \mathbb{C}$  such that  $\Re(\alpha) > \Re(\beta) > 0$

a) If  $0 < a < b < \infty$  and  $1 \leq p < \infty$ , then for  $\varphi \in L^p(a, b)$

$$\mathfrak{D}_{a+}^{\beta} \mathcal{J}_{a+}^{\alpha} \varphi = \mathcal{J}_{a+}^{\alpha-\beta} \varphi \quad \text{and} \quad \mathfrak{D}_{b-}^{\beta} \mathcal{J}_{b-}^{\alpha} \varphi = \mathcal{J}_{b-}^{\alpha-\beta} \varphi$$

If  $\alpha, \beta \in \mathbb{C}$  such that  $\Re(\alpha) > \Re(\beta) > 0$ , then

$$\mathcal{J}_{a+}^{\alpha} \mathcal{J}_{a+}^{\beta} \varphi = \mathcal{J}_{a+}^{\alpha+\beta} \varphi \quad \text{and} \quad \mathcal{J}_{b-}^{\alpha} \mathcal{J}_{b-}^{\beta} \varphi = \mathcal{J}_{b-}^{\alpha+\beta} \varphi \quad (2.69)$$

If  $\beta = m \in \mathbb{N}$ , then

$$\mathfrak{D}_{a+}^m \mathcal{J}_{a+}^{\alpha} \varphi = \mathcal{J}_{a+}^{\alpha-m} \varphi \quad \text{and} \quad \mathfrak{D}_{b-}^m \mathcal{J}_{b-}^{\alpha} \varphi = \mathcal{J}_{b-}^{\alpha-m} \varphi \quad (2.70)$$

b) If  $\mu \in \mathbb{C}$ ,  $c \in \mathbb{R}$ ,  $a = 0$  and  $b = \infty$ , then for  $\varphi \in X_c^p(\mathbb{R}^+)$

$$\begin{aligned} \mathfrak{D}_{0+,\mu}^{\beta} \mathcal{J}_{0+,\mu}^{\alpha} \varphi &= \mathcal{J}_{0+,\mu}^{\alpha-\beta} \varphi \quad \Re(\mu) > c, \\ \mathfrak{D}_{-,\mu}^{\beta} \mathcal{J}_{-,\mu}^{\alpha} \varphi &= \mathcal{J}_{-,\mu}^{\alpha-\beta} \varphi \quad \Re(\mu) > -c \end{aligned} \quad (2.71)$$

If  $\beta = m \in \mathbb{N}$ , then

$$\begin{aligned} \mathfrak{D}_{0+,\mu}^m \mathcal{J}_{0+,\mu}^{\alpha} \varphi &= \mathcal{J}_{0+,\mu}^{\alpha-m} \varphi \quad \Re(\mu) > c, \\ \mathfrak{D}_{-,\mu}^m \mathcal{J}_{-,\mu}^{\alpha} \varphi &= \mathcal{J}_{-,\mu}^{\alpha-m} \varphi \quad \Re(\mu) > -c \end{aligned} \quad (2.72)$$

When  $\mu = 0$  and  $m \in \mathbb{N}$ ,

$$\mathfrak{D}_{0+}^{\beta} \mathcal{J}_{0+}^{\alpha} \varphi = \mathcal{J}_{0+}^{\alpha-\beta} \varphi \quad c < 0, \quad \mathfrak{D}_{-}^{\beta} \mathcal{J}_{-}^{\alpha} \varphi = \mathcal{J}_{-}^{\alpha-\beta} \varphi \quad c > 0 \quad (2.73)$$

$$\mathfrak{D}_{0+}^m \mathcal{J}_{0+}^{\alpha} \varphi = \mathcal{J}_{0+}^{\alpha-m} \varphi \quad c < 0, \quad \mathfrak{D}_{-}^m \mathcal{J}_{-}^{\alpha} \varphi = \mathcal{J}_{-}^{\alpha-m} \varphi \quad c > 0 \quad (2.74)$$

## 2.4 Applications of Fractional Derivatives

In this section, some few applications out of the vast applications of fractional calculus are studied.

### 2.4.1 Viscoelasticity

Hooke gave a connection between stress and strain for solids as

$$\sigma(t) = E\epsilon(t) \quad (2.75)$$

In the case of Newtonian fluids

$$\sigma(t) = \eta \frac{d\epsilon(t)}{dt} \quad (2.76)$$

Initially, Hooke's (elastic) and Newton's (viscous) elements were combined with the aim of combining the properties of both. These give Maxwell's model of viscoelasticity as well as Voigt's model. However, both these models have obvious disadvantages.

In the case of the Maxwell model, described by

$$\frac{d\epsilon}{dt} = \frac{1}{E} \frac{d\sigma}{dt} + \frac{\sigma}{\eta} \quad (2.77)$$

it implies

$$\sigma = \text{const} \quad \Rightarrow \quad \frac{d\epsilon}{dt} = \text{const} \quad (2.78)$$

That is, if stress is constant, then the strain grows infinitely. This does not correspond to experimental observations.

On the other hand, Voigt model is given by

$$\sigma = E\epsilon + \eta \frac{d\epsilon}{dt} \quad (2.79)$$

It follows that

$$\epsilon = \text{const} \quad \Rightarrow \quad \sigma = \text{const} \quad (2.80)$$

This means that there will be no stress relaxation. Such problems cannot be overcome with the integer-order models.

But it is natural to suppose, as suggested by G. W. Scott Blair, that for "intermediate" materials stress may be proportional to the stress derivative of "intermediate" (non-integer) order:

$$\sigma(t) = E(D_{0+}^{\alpha}\epsilon)(t) \quad 0 < \alpha < 1 \quad (2.81)$$

Where  $E$  and  $\alpha$  are material-dependent constant.

A. N. Gerasimov suggested a similar generalisation of the basic law of deformation using Caputo fractional derivative

$$\sigma(t) = \kappa({}^C D_-^{\alpha}\epsilon)(t) \quad (2.82)$$

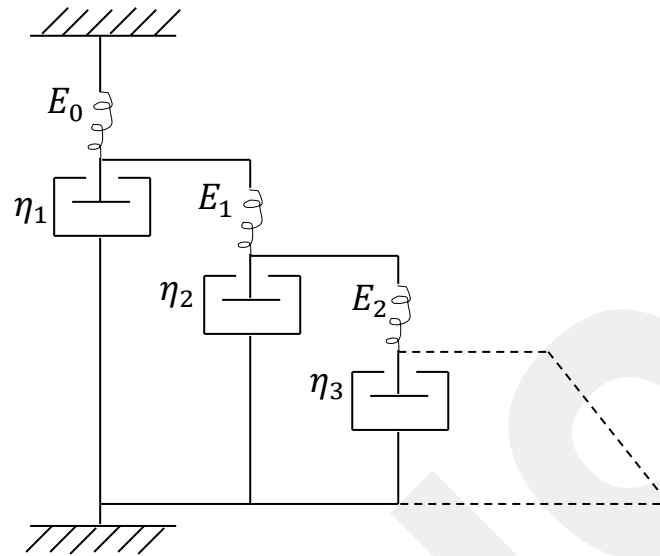

Figure 4.1: Schiessel and Blumen's fractance-type model

#### 2.4.2 Ultrasonic wave propagation in human cancellous bone

Cancellous bone, otherwise known as trabecular bone or spongy bone, is one of two kinds of osseous tissue which form bones. Unlike other type of osseous tissue such as compact bone (cortical bone), it has a greater surface area but less dense, softer, weaker, and less firm. It usually occurs at the ends of long bones, proximal to joints and within the interior of vertebrae.

As shown seen in section 2.4.1, fractional calculus is used to describe the viscous connections between fluid and solid structure. Reflection and transmission scattering operators are derived for a slab of cancellous bone in the elastic frame by using Blot's theory. Experimental results are compared with theoretical predictions for slow and fast waves transmitted through human cancellous bone samples.

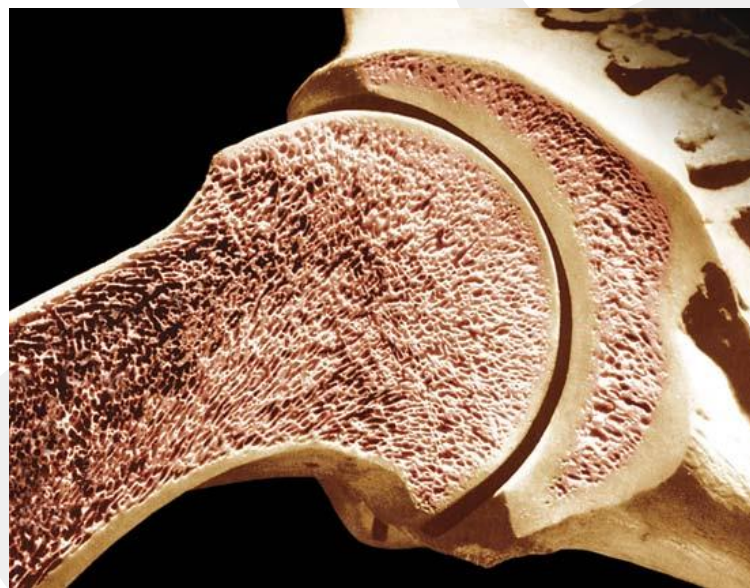
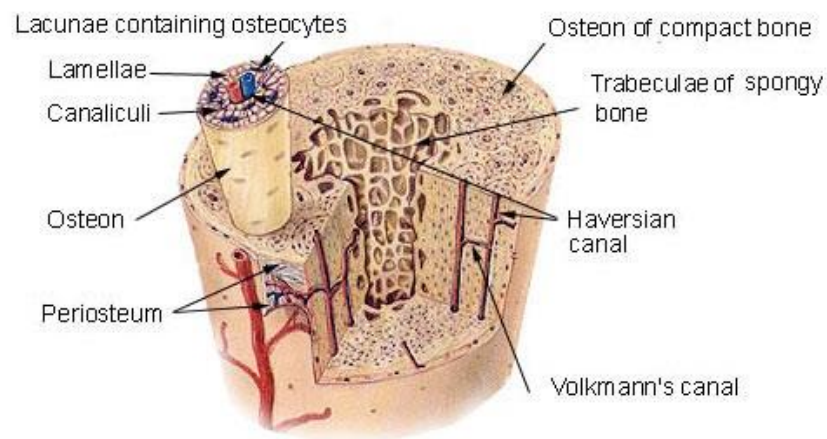

Figure 4.2: Cancellous bone

### 2.4.3 Neurophysiology of eye movements

A model on the neurodynamics of the vestibulo-ocular reflex (VOR) designed to keep the retinal image stable by producing eye rotations which counterbalance head rotations was described by Robinson. At lower frequencies (less than 0.3Hz), the dynamics of canal afferents  $A(s)$  and vestibular and prepositus nuclei neurons  $V(s)$  reflect those of the canal receptors, and frequency response of neural discharge rate relative to angular velocity  $\Omega(s)$  can be described as

$$\frac{V(s)}{\Omega(s)} = \frac{s\tau_v}{(s\tau_v + 1)} \quad (2.83)$$

where  $s = i\omega = 2\pi i\nu$  is the Laplace transform variable with  $\omega$  in radians/s and  $\nu$  in Hz,  $\tau_v$  is the vestibular time constant. Motoneurons ( $M$ ) dynamics could offset the mechanical lag of the eye when the frequency is above 0.3Hz, and thus, the frequency response of neural discharge rate relative to eye angular position ( $E$ ) is approximately equal to a first-order leading function as

$$\frac{M(s)}{E(s)} = s\tau_e + 1 \quad (2.84)$$

where  $\tau_e$  is the eye time constant.

Anastasio realised some problems using usual integer-order models to describe the behaviour of premotor neurons. To resolve these problems, he suggested a fractional-order model in terms of the Laplace transform  $R(s)$  of the premotor neuron discharge rate  $r(t)$  and the Laplace transform  $\Omega(s)$  of the angular velocity of the head in the form

$$G(s) = \frac{R(s)}{\Omega(s)} = \frac{\tau_1(s\tau_2 + 1)s^{\alpha_d - \alpha_i}}{(s\tau_1 + 1)} \quad (2.85)$$

where  $\tau_1$  and  $\tau_2$  represent time constants of the neuron model,  $\alpha_d$  and  $\alpha_i$  are, respectively, fractional-order derivative and integral of the model.

#### 2.4.4 Electrochemistry and tracer fluid flows

Oldham and his associates have given substantial attention to a new approach they have established to the solution of electrochemical problems that deal with diffusion phenomena. Subsequently, Goto and Ishii developed the idea of semi-differential electro-analysis with the fractional-order diffusion equation that may occur in other fields including diffusion, heat conduction, and mass transfer. Oldham and Spanier also proposed the replacement of the usual integer-order called Fick's law that describes the diffusion of electro-active species toward the electrodes by a fractional-order integral law in the form

$$(D_{0+}^{-1/2}i)(t) = KC_0 \left[ \left\{ 1 - \frac{C(0,t)}{C_0} \right\} + \frac{\sqrt{\kappa}}{R} D_{0+}^{-1/2} \left\{ 1 - \frac{C(0,t)}{C_0} \right\} \right] \quad (2.86)$$

where  $C_0$  is the uniform concentration of electro-active species,  $\kappa$  is the diffusion coefficient, and  $K$  and  $R$  are constants.

This diffusion problem can be applied to modelling diffusion of atmospheric pollutants by taking  $C(z,t)$  to be the concentration of pollutant at height  $z$  at time  $t$  so that  $C(z,0) = 0$ .

## CHAPTER 3

### REVIEW OF CAPUTO-HADAMARD FRACTIONAL DERIVATIVES AND FTFC IN CAPUTO SETTINGS

#### 3.1 Caputo-Hadamard Fractional Derivatives

##### Definition 3.1

The Caputo-type modification of the left-sided and right-sided Hadamard fractional derivatives are defined respectively by

$${}^c\mathcal{D}_{a+}^{\alpha}\varphi(x) = \mathcal{D}_{a+}^{\alpha} \left[ \varphi(t) - \sum_{k=0}^{n-1} \frac{\delta^k \varphi(a)}{k!} \left( \log \frac{t}{a} \right)^k \right] (x) \quad (3.1)$$

$${}^c\mathcal{D}_{b-}^{\alpha}\varphi(x) = \mathcal{D}_{b-}^{\alpha} \left[ \varphi(t) - \sum_{k=0}^{n-1} \frac{(-1)^k \delta^k \varphi(b)}{k!} \left( \log \frac{b}{t} \right)^k \right] (x) \quad (3.2)$$

Where  $\Re(\alpha) \geq 0$ ,  $n = [\Re(\alpha) + 1]$  and  $\varphi(x) \in AC_{\delta}^n[a, b]$   $0 < a < b < \infty$ .

In particular, if  $0 < \Re(\alpha) < 1$ , then

$${}^c\mathcal{D}_{a+}^{\alpha}\varphi(x) = \mathcal{D}_{a+}^{\alpha}[\varphi(t) - \varphi(a)](x) \quad (3.3)$$

$${}^c\mathcal{D}_{b-}^{\alpha}\varphi(x) = \mathcal{D}_{b-}^{\alpha}[\varphi(t) - \varphi(b)](x) \quad (3.4)$$

##### Theorem 3.1

Let  $\Re(\alpha) \geq 0$ ,  $n = [\Re(\alpha)] + 1$  and  $\varphi \in AC_{\delta}^n[a, b]$   $0 < a < b < \infty$ . Then

${}^c\mathcal{D}_{a+}^{\alpha}\varphi(x)$  and  ${}^c\mathcal{D}_{b-}^{\alpha}\varphi(x)$  exist everywhere on  $[a, b]$  and

a) If  $\alpha \notin \mathbb{N}_0$ ,

$${}^c\mathcal{D}_{a+}^{\alpha}\varphi(x) = \frac{1}{\Gamma(n - \alpha)} \int_a^x \left( \log \frac{x}{t} \right)^{n-\alpha-1} \delta^n \varphi(t) \frac{dt}{t} = J_{a+}^{n-\alpha} \delta^n \varphi(x) \quad (3.5)$$

$$\begin{aligned}
{}^c\mathcal{D}_{b-}^{\alpha}\varphi(x) &= \frac{(-1)^n}{\Gamma(n-\alpha)} \int_x^b \left(\log \frac{t}{x}\right)^{n-\alpha-1} \delta^n \varphi(t) \frac{dt}{t} \\
&= (-1)^n J_{b-}^{n-\alpha} \delta^n \varphi(x)
\end{aligned} \tag{3.6}$$

b) If  $\alpha = n \in \mathbb{N}_0$ ,

$${}^c\mathcal{D}_{a+}^{\alpha}\varphi(x) = \delta^n \varphi(x), \quad {}^c\mathcal{D}_{b-}^{\alpha}\varphi(x) = (-1)^n \delta^n \varphi(x) \tag{3.7}$$

In particular,

$${}^c\mathcal{D}_{a+}^0\varphi(x) = {}^c\mathcal{D}_{b-}^0\varphi(x) = \varphi(x) \tag{3.8}$$

**Proof:**

a) Let  $\alpha \notin \mathbb{N}_0$ . Using equations (2.56) and (3.1) and using integration by part by taking  $u = \varphi(t) - \sum_{k=0}^{n-1} \frac{\delta^k \varphi(a)}{k!} \left(\log \frac{t}{a}\right)^k$  and

$$dv = \left(\log \frac{x}{t}\right)^{n-\alpha-1} \frac{\varphi(t) dt}{t}$$

we obtain

$$\begin{aligned}
{}^c\mathcal{D}_{a+}^{\alpha}\varphi(x) &= \\
&= \left(x \frac{d}{dx}\right)^n \left\{ \left[ -\frac{1}{n-\alpha} \left(\log \frac{x}{t}\right)^{n-\alpha} \left( \varphi(t) - \sum_{k=0}^{n-1} \frac{\delta^k \varphi(a)}{k!} \left(\log \frac{t}{a}\right)^k \right) \right] \right\}_a^x \\
&\quad + \frac{1}{n-\alpha} \int_a^x \left(\log \frac{x}{t}\right)^{n-\alpha} \left[ \delta \varphi(t) - \sum_{k=1}^{n-1} \frac{\delta^k \varphi(a)}{k!} \left(\log \frac{t}{a}\right)^k \right] \frac{dt}{t} \\
&= \left(x \frac{d}{dx}\right)^{n-1} \int_a^x \left(\log \frac{x}{t}\right)^{n-\alpha} \left[ \delta \varphi(t) - \sum_{k=1}^{n-1} \frac{\delta^k \varphi(a)}{k!} \left(\log \frac{t}{a}\right)^k \right] \frac{dt}{t} \\
&= \dots = x \frac{d}{dx} \frac{1}{\Gamma(n-\alpha)} \int_a^x \left(\log \frac{x}{t}\right)^{n-\alpha-1} (\delta^{n-1} \varphi(t) - \delta^{n-1} \varphi(a)) \frac{dt}{t}
\end{aligned}$$

Integrating by part once more again with the same choice of  $dv$ , we obtain equation (3.5). Equation (3.6) is proved in a similar way.

b) Let  $\alpha = n \in \mathbb{N}_0$ , then

$${}^c\mathcal{D}_{a+}^n \varphi(x) = \mathcal{D}_{a+}^n \left[ \varphi(t) - \sum_{k=0}^{n-1} \frac{\delta^k \varphi(a)}{k!} \left(\log \frac{t}{a}\right)^k \right] (x)$$

i.e.

$$\begin{aligned}\varphi(x) &= J_{a+}^n {}^c\mathcal{D}_{a+}^n \varphi(x) + \sum_{k=0}^{n-1} \frac{\delta^k \varphi(a)}{k!} \left(\log \frac{x}{a}\right)^k \\ &= \frac{1}{(n-1)!} \int_a^x \left(\log \frac{x}{t}\right)^{n-1} {}^c\mathcal{D}_{a+}^n \varphi(t) \frac{dt}{t} + \sum_{k=0}^{n-1} \frac{\delta^k \varphi(a)}{k!} \left(\log \frac{x}{a}\right)^k\end{aligned}$$

From equation (1.16), we obtain  ${}^c\mathcal{D}_{a+}^\alpha \varphi(x) = \delta^\alpha \varphi(x)$ . In a similar way, we obtain the second relation in equation (3.7).

### Lemma 3.1

Let  $\Re(\alpha) > 0$ ,  $n = [\Re(\alpha) + 1]$  and  $\varphi \in C[a, b]$ .

a) If  $\Re(\alpha) \neq 0$  or  $\alpha \in \mathbb{N}$ , then

$${}^c\mathcal{D}_{a+}^\alpha (J_{a+}^\alpha \varphi)(x) = \varphi(x), \quad {}^c\mathcal{D}_{b-}^\alpha (J_{b-}^\alpha \varphi)(x) = \varphi(x) \quad (3.9)$$

b) If  $\Re(\alpha) \in \mathbb{N}$  and  $\Re(\alpha) \neq 0$  then

$${}^c\mathcal{D}_{a+}^\alpha (J_{a+}^\alpha \varphi)(x) = \varphi(x) - \frac{J_{a+}^{\alpha+1-n} \varphi(a)}{\Gamma(n-\alpha)} \left(\log \frac{x}{a}\right)^{n-\alpha} \quad (3.10)$$

$${}^c\mathcal{D}_{b-}^\alpha (J_{b-}^\alpha \varphi)(x) = \varphi(x) - \frac{J_{b-}^{\alpha+1-n} \varphi(b)}{\Gamma(n-\alpha)} \left(\log \frac{b}{x}\right)^{n-\alpha} \quad (3.11)$$

### Lemma 3.2

Let  $\varphi \in AC_\delta^n[a, b]$  or  $C_\delta^n[a, b]$  and  $\alpha \in \mathbb{C}$ , then

$$J_{a+}^\alpha ({}^c\mathcal{D}_{a+}^\alpha \varphi)(x) = \varphi(x) - \sum_{k=0}^{n-1} \frac{\delta^k \varphi(a)}{k!} \left(\log \frac{x}{a}\right)^k \quad (3.12)$$

$$J_{b-}^\alpha ({}^c\mathcal{D}_{b-}^\alpha \varphi)(x) = \varphi(x) - \sum_{k=0}^{n-1} \frac{\delta^k \varphi(b)}{k!} \left(\log \frac{b}{x}\right)^k \quad (3.13)$$

#### Proof:

The proof of (3.12) and (3.13) follows from the identities

$${}^c\mathcal{D}_{a+}^\alpha \varphi(x) = J_{a+}^{n-\alpha} \varphi(x) \text{ and } {}^c\mathcal{D}_{b-}^\alpha \varphi(x) = J_{b-}^{n-\alpha} \varphi(x) \text{ respectively.}$$

### Property 3.1

Let  $\Re(\alpha) \geq 0$ ,  $n = [\Re(\alpha)] + 1$  and  $\Re(\beta) > 0$ , then

$${}^c\mathcal{D}_{a+}^{\alpha} \left( \log \frac{x}{a} \right)^{\beta-1} = \frac{\Gamma(\beta)}{\Gamma(\beta-\alpha)} \left( \log \frac{x}{a} \right)^{\beta-\alpha-1} \quad \Re(\beta) > n \quad (3.14)$$

$${}^c\mathcal{D}_{b-}^{\alpha} \left( \log \frac{b}{x} \right)^{\beta-1} = \frac{\Gamma(\beta)}{\Gamma(\beta-\alpha)} \left( \log \frac{b}{x} \right)^{\beta-\alpha-1} \quad \Re(\beta) > n \quad (3.15)$$

$${}^c\mathcal{D}_{a+}^{\alpha} \left( \log \frac{x}{a} \right)^k = 0, \quad {}^c\mathcal{D}_{b-}^{\alpha} \left( \log \frac{b}{x} \right)^k = 0 \quad k = 0, 1, \dots, n-1 \quad (3.16)$$

In particular, when  $\beta = 1$

$$({}^c\mathcal{D}_{a+}^{\alpha} 1) = 0, \quad ({}^c\mathcal{D}_{b-}^{\alpha} 1) = 0 \quad (3.17)$$

On the half-axis  $\mathbb{R}^+$ , the Caputo-Hadamard fractional derivative take the form

$${}^c\mathcal{D}_{0+}^{\alpha} \varphi(x) = \frac{1}{\Gamma(n-\alpha)} \int_0^x \left( \log \frac{x}{t} \right)^{n-\alpha-1} \delta^n \varphi(t) \frac{dt}{t} \quad (3.18)$$

$${}^c\mathcal{D}_{-}^{\alpha} \varphi(x) = \frac{(-1)^n}{\Gamma(n-\alpha)} \int_x^{\infty} \left( \log \frac{t}{x} \right)^{n-\alpha-1} \delta^n \varphi(t) \frac{dt}{t} \quad (3.19)$$

### 3.2 FTFC in Caputo Settings

The fundamental theorem of calculus (FTC) states that the two fundamental operations in calculus, differentiation and integration, are inverse to one another. i.e. when we first integrate a continuous function and then we differentiate, the original function is obtained.

$$D {}_a I_x \varphi(x) = \varphi(x) \quad (3.20)$$

Where  $D = \frac{d}{dx}$  and  ${}_a I_x \varphi(x) = \int_a^x \varphi(t) dt$ .

Consequently, one can compute integrals by using an antiderivative of the function to be integrated what is otherwise known as the second fundamental theorem of calculus.

$${}_a I_b D \varphi(x) = \varphi(b) - \varphi(a) \quad (3.21)$$

In fractional case, if Riemann-Liouville integrals and derivatives are to be used [10, 16], (3.21) cannot be generalized, since

$${}_a I_b D_{a+}^{\alpha} \varphi(x) \neq \varphi(b) - \varphi(a) \quad (3.22)$$

The FTC talks about how the integral of a function  $\varphi$  over the interval  $[a, b]$  can be calculated by finding an antiderivative  $\Phi$ , i.e., a function, whose derivative is  $\varphi$ . The FTFC for finite interval  $[a, b]$  can be generalized in the Caputo settings as follows [19].

**Theorem 3.2**

(a) Let  $\varphi(x)$  be a real-valued function defined on a closed interval  $[a, b]$ .

Let  $\Phi(x)$  be the function defined for  $x$  in  $[a, b]$  by

$$\Phi(x) = I_{a+}^{\alpha} \varphi(x) \tag{3.23}$$

where  $I_{a+}^{\alpha}$  is the Riemann-Liouville fractional integral defined by (xx).

Then

$${}^c D_{a+}^{\alpha} \Phi(x) = \varphi(x) \tag{3.24}$$

for  $x \in (a, b)$ , where  ${}^c D_{a+}^{\alpha}$  is the Caputo fractional derivative.

(b) Given a real-valued function  $\varphi(x)$  defined on a closed interval  $[a, b]$ ,

then if  $\Phi(x)$  is a function given by (3.23), then

$$I_{a+}^{\alpha} \varphi(x) = F(b) - F(a) \tag{3.25}$$

Observe that (3.25) may be considered as fractional Newton-Leibniz formula.

## CHAPTER 4

### ON CAPUTO MODIFICATION OF THE HADAMARD FRACTIONAL DERIVATIVES

#### 4.1 FTFC in the Caputo-Hadamard Setting

The fundamental theorem of calculus FTC

$$\frac{d}{dx} \int_a^x f(t)dt = f(x) \quad \text{and} \quad \int_a^b dt \frac{d}{dt} F(t) = F(b) - F(a) = F(t)|_a^b \quad (4.1)$$

replaces tedious computations of the limit of sums of rectangular areas with a more easier way of finding an anti-derivative. The first part of the theorem says that integration can be reversed by a differentiation for a continuous function. The second part allows one to find the definite integral of a function using any of its anti-derivatives.

In the fractional case, Riemann-Liouville as well as Hadamard integro-differentiation (for example) do not have generalisation of the Fundamental Theorem of Fractional Calculus (FTFC) in the form of (4.1). i.e.

$$({}_a I_b^\alpha D_{a+}^\alpha \varphi)(x) \neq \varphi(b) - \varphi(a), \quad ({}_a I_b^\alpha D_{b-}^\alpha \varphi)(x) \neq \varphi(a) - \varphi(b) \quad (4.2)$$

$$({}_a J_b^\alpha \mathfrak{D}_{a+}^\alpha \varphi)(x) \neq \varphi(b) - \varphi(a), \quad ({}_a J_b^\alpha \mathfrak{D}_{b-}^\alpha \varphi)(x) \neq \varphi(a) - \varphi(b) \quad (4.3)$$

This is because the differential operators  $D^n = \left(\frac{d}{dx}\right)^n$  and  $\delta^n = \left(x \frac{d}{dx}\right)^n$  used in the definitions of Riemann-Liouville and Hadamard fractional derivatives respectively, appear outside the integrals and therefore as those operators and the integrals are not commutative, the semi-group properties for integrals (2.94) and lemma 2.3 of [2] cannot be applied. i.e.

$$(I_{a+}^\alpha D_{a+}^\alpha \varphi)(x) = I_{a+}^\alpha D^n I_{a+}^{n-\alpha} \varphi(x) \neq I_{a+}^\alpha I_{a+}^{n-\alpha} D^n \varphi(x) \quad (4.4)$$

$$(J_{a+}^\alpha \mathfrak{D}_{a+}^\alpha \varphi)(x) = J_{a+}^\alpha \delta^n J_{a+}^{n-\alpha} \varphi(x) \neq J_{a+}^\alpha J_{a+}^{n-\alpha} \delta^n \varphi(x) \quad (4.5)$$

However, from theorem 2.3 of [2], we have

$$(J_{a+}^{\alpha} \mathfrak{D}_{a+}^{\alpha} \varphi)(x) = \varphi(x) - \sum_{j=1}^n \frac{(\delta^{n-j} (J_{a+}^{n-\alpha} \varphi))(a)}{\Gamma(\alpha - j + 1)} \left(\log \frac{x}{a}\right)^{\alpha-j} \quad (4.6)$$

In particular, if  $0 < \Re(\alpha) < 1$ , then  $n = 1$  and

$$(J_{a+}^{\alpha} \mathfrak{D}_{a+}^{\alpha} \varphi)(x) = \varphi(x) - \frac{(J_{a+}^{1-\alpha} \varphi)(a)}{\Gamma(\alpha)} \left(\log \frac{x}{a}\right)^{\alpha-1} \quad (4.7)$$

If  $\alpha = 1$ , then

$$(J_{a+}^1 \mathfrak{D}_{a+}^1 \varphi)(x) = \varphi(x) - \varphi(a) \quad (4.8)$$

which implies

$$({}_a J_b^1 \mathfrak{D}_{a+}^1 \varphi)(x) = \varphi(b) - \varphi(a) \quad (4.9)$$

Thus, (4.7) cannot be considered as the fractional generalisation of FTC in the form of (4.1). Similarly, using lemma 2.5 of [2], we can see that Riemann-Liouville fractional integrals and derivatives cannot be used to generalise FTFC in the form of (4.1) as well.

On the other hand, replacing the Riemann-Liouville fractional derivative with Caputo fractional derivative, it was shown (for example, [6] and [13]) that

$$({}_a I_b^{\alpha c} D_{a+}^{\alpha} \varphi)(x) = \varphi(b) - \varphi(a) \quad (4.10)$$

**Note:** In most cases, I will only be using the left-sided definitions of fractional derivatives or integrals where the definitions are quite similar to the right-sided ones.

Therefore (4.10) can be considered as a fractional generalisation of FTC in the form of (4.1).

In the next theorem, we give the FTFC in the Caputo-Hadamard setting.

**Theorem 4.1: Fundamental theorem of fractional calculus**

Let  $\alpha \in \mathbb{C}$  with  $\Re(\alpha) \geq 0$  and  $n = [\Re(\alpha)] + 1$ . Let  $\varphi(x) \in AC_{\delta}^n[a, b]$ ,  $0 < a < b < \infty$ .

- a) If  $\Phi(x) = J_{a+}^{\alpha} \varphi(x)$  or  $\Phi(x) = J_{b-}^{\alpha} \varphi(x) \quad \forall x \in [a, b]$ , then

$${}^c\mathcal{D}_{a+}^\alpha \Phi(x) = \varphi(x), \quad {}^c\mathcal{D}_{b-}^\alpha \Phi(x) = \varphi(x) \quad (4.11)$$

$$\begin{aligned} \text{b) } {}_aJ_b^{\alpha c} \mathcal{D}_{a+}^\alpha \Phi(x) &= \Phi(b) - \Phi(a), \\ {}_aJ_b^{\alpha c} \mathcal{D}_{b-}^\alpha \Phi(x) &= \Phi(a) - \Phi(b) \end{aligned} \quad (4.12)$$

**Proof**

a) Using lemma 2.4 of [8], it can be seen that the Hadamard fractional integrals and the Caputo-Hadamard fractional derivatives are inverse operations.

$$({}^c\mathcal{D}_{a+}^\alpha J_{a+}^\alpha)\varphi(x) = \varphi(x), \quad ({}^c\mathcal{D}_{b-}^\alpha J_{b-}^\alpha)\varphi(x) = \varphi(x) \quad (4.13)$$

Thus, if  $\Phi(x) = J_{a+}^\alpha \varphi(x)$  or  $\Phi(x) = J_{b-}^\alpha \varphi(x)$  then we have (34).

b) Using (3.5), we have

$$J_{a+}^{\alpha c} \mathcal{D}_{a+}^\alpha \Phi(x) = J_{a+}^\alpha J_{a+}^{n-\alpha} \delta^n \Phi(x) \quad (4.14)$$

In this case we can apply the semi-group property (2.69), unlike in the cases of Hadamard and Riemann-Liouville fractional derivatives where  $\delta^n$  and  $D^n$  respectively, are located outside the integrals.

Therefore

$$J_{a+}^{\alpha c} \mathcal{D}_{a+}^\alpha \Phi(x) = J_{a+}^n \delta^n \Phi(x) \quad (4.15)$$

In particular, if  $n = 1$ , then

$$\begin{aligned} J_{a+}^{\alpha c} \mathcal{D}_{a+}^\alpha \Phi(x) &= J_{a+}^1 \delta^1 \Phi(x) \\ &= \frac{1}{\Gamma(1)} \int_a^x \frac{dt}{t} \cdot t \frac{d}{dt} \Phi(t) \\ &= \int_a^x dt \frac{d}{dt} \Phi(t) = \Phi(x) - \Phi(a) \end{aligned}$$

$$\Rightarrow {}_aJ_b^{\alpha c} \mathcal{D}_{a+}^\alpha \Phi(x) = \int_a^b dt \frac{d}{dt} \Phi(t) = \Phi(b) - \Phi(a)$$

Alternatively, using lemma 2.5 of [8], we have

$$J_{a+}^{\alpha c} \mathcal{D}_{a+}^\alpha \Phi(x) = \Phi(x) - \sum_{j=0}^{n-1} \frac{\delta^j \Phi(a)}{\Gamma(j+1)} \left( \log \frac{x}{a} \right)^j \quad (4.16)$$

In particular, if  $0 < \Re(\alpha) < 1$ , then  $n = 1$  and  $\Phi(x) \in AC_\delta[a, b]$  or  $\Phi(x) \in \mathcal{C}_\delta[a, b]$ . Thus

$$J_{a+}^{\alpha c} \mathcal{D}_{a+}^\alpha \Phi(x) = \Phi(x) - \Phi(a) \quad (4.17)$$

Hence  ${}_a J_b^\alpha {}^c \mathcal{D}_{a+}^\alpha \Phi(x)$  gives (4.12). The right-sided case can be proven in a similar way.

**Lemma 4.1**

Let  $\alpha \in \mathbb{C}$  with  $\Re(\alpha) \geq 0$  and  $n = [\Re(\alpha)] + 1$ . If  $\varphi(x) \in AC_\delta^n[a, b]$ , where  $0 < a < b < \infty$ , then

$$\begin{aligned} \varphi(x) &= \varphi(a) + \frac{{}^c \mathcal{D}_{a+}^\alpha \varphi(\xi)}{\Gamma(\alpha + 1)} \left(\log \frac{x}{a}\right)^\alpha \quad \xi \in (a, x) \quad \text{or} \\ \varphi(x) &= \varphi(b) + \frac{{}^c \mathcal{D}_{b-}^\alpha \varphi(\xi)}{\Gamma(\alpha + 1)} \left(\log \frac{b}{x}\right)^\alpha \quad \xi \in (x, b) \end{aligned} \quad (4.18)$$

This is where we make the first use of theorem 2.

**Proof**

Using (2.50) and (4.17), we obtain

$$\frac{1}{\Gamma(\alpha)} \int_a^x \left(\log \frac{x}{t}\right)^{\alpha-1} {}^c \mathcal{D}_{a+}^\alpha \varphi(t) \frac{dt}{t} = \varphi(x) - \varphi(a)$$

where the function is  ${}^c \mathcal{D}_{a+}^\alpha \varphi(t)$ . Applying the Mean Value Theorem for integrals [14, page 287] we have

$${}^c \mathcal{D}_{a+}^\alpha \varphi(\xi) \frac{1}{\Gamma(\alpha)} \int_a^x \left(\log \frac{x}{t}\right)^{\alpha-1} \frac{dt}{t} = \varphi(x) - \varphi(a) \quad \xi \in (a, x) \quad (4.19)$$

The left hand side of (4.19) contains the Hadamard fractional integral of the function  $\varphi(t) = 1$ , i.e.,  $J_{a+}^\alpha(1)$ . Then by definition implies  $\beta = 1$  and thus (4.19) becomes

$$\frac{{}^c \mathcal{D}_{a+}^\alpha \varphi(\xi)}{\Gamma(\alpha + 1)} \left(\log \frac{x}{t}\right)^\alpha = \varphi(x) - \varphi(a) \quad \xi \in (a, x) \quad (4.20)$$

Rearranging (4.20) gives (4.18). This completes the proof.

Note that the right-sided case can also be proven in a similar way.

**Lemma 4.2**

If  $\alpha \in \mathbb{C}$  with  $\Re(\alpha) \geq 0$ ,  $n = [\Re(\alpha)] + 1$  and  $k, m \in \mathbb{N}$ .  $\varphi(x) \in AC_\delta^n[a, b]$ ,  $0 < a < b < \infty$ , then

$$\begin{aligned}
(J_{a+}^{\alpha})^k ({}^c\mathcal{D}_{a+}^{\alpha})^m \varphi(x) &= \frac{({}^c\mathcal{D}_{a+}^{\alpha})^m \varphi(\xi)}{\Gamma(k\alpha + 1)} \left(\log \frac{x}{a}\right)^{k\alpha} \quad \xi \in (a, x) \quad \text{or} \\
(J_{b-}^{\alpha})^k ({}^c\mathcal{D}_{b-}^{\alpha})^m \varphi(x) &= \frac{({}^c\mathcal{D}_{b-}^{\alpha})^m \varphi(\xi)}{\Gamma(k\alpha + 1)} \left(\log \frac{b}{x}\right)^{k\alpha} \quad \xi \in (x, b)
\end{aligned} \tag{4.21}$$

**Proof**

The proof is similar to the proof of lemma 4.1. Observe that the sequential integral

$$(J_{a+}^{\alpha})^k = \underbrace{J_{a+}^{\alpha} J_{a+}^{\alpha} \dots J_{a+}^{\alpha}}_{k\text{-times}} \tag{4.22}$$

can be written as the  $J_{a+}^{k\alpha}$  with order  $k\alpha$  by the semi-group property (2.69).

Thus,

$$(J_{a+}^{\alpha})^k ({}^c\mathcal{D}_{a+}^{\alpha})^m \varphi(x) = \frac{1}{\Gamma(k\alpha)} \int_a^x \left(\log \frac{x}{t}\right)^{k\alpha-1} ({}^c\mathcal{D}_{a+}^{\alpha})^m \varphi(t) \frac{dt}{t} \tag{4.23}$$

Applying mean value theorem for integral and simplify as before we obtain (4.21).

**Lemma 4.3**

$\Re(\alpha) \geq 0$  and  $n = [\Re(\alpha)] + 1$ , if  $\varphi$  is a function such that  ${}^c\mathcal{D}_{a+}^{\alpha}\varphi$  and  $\mathcal{D}_{a+}^{\alpha}\varphi$  exist, then

$${}^c\mathcal{D}_{a+}^{\alpha}\varphi(x) = \mathcal{D}_{a+}^{\alpha}\varphi(x) - \sum_{k=0}^{n-1} \frac{\delta^k \varphi(a)}{\Gamma(k - \alpha + 1)} \left(\log \frac{x}{a}\right)^{k-\alpha} \tag{4.24}$$

and when  $0 < \Re(\alpha) < 1$  then

$${}^c\mathcal{D}_{a+}^{\alpha}\varphi(x) = \mathcal{D}_{a+}^{\alpha}\varphi(x) - \frac{\varphi(a)}{\Gamma(1 - \alpha)} \left(\log \frac{x}{a}\right)^{-\alpha} \tag{4.25}$$

**Proof**

Using (2.56) and (3.1), we obtain

$$\begin{aligned}
{}^c\mathcal{D}_{a+}^{\alpha}\varphi(x) &= \mathcal{D}_{a+}^{\alpha}\varphi(x) - \sum_{k=0}^{n-1} \frac{\delta^k \varphi(a)}{k!} \left( \mathcal{D}_{a+}^{\alpha} \left(\log \frac{t}{a}\right)^k \right) (x) \\
&= \mathcal{D}_{a+}^{\alpha}\varphi(x) - \sum_{k=0}^{n-1} \frac{\delta^k \varphi(a)}{\Gamma(k+1)} \cdot \frac{\Gamma(k+1)}{\Gamma(k-\alpha+1)} \left(\log \frac{x}{a}\right)^{k-\alpha}
\end{aligned}$$

Thus we have (4.24). Then if  $0 < \Re(\alpha) < 1$ , implies  $n = 1$  and from (4.24) we have (4.25). We can get an immediate consequence of lemma 4.3.

**Corollary 4.1**

Under the conditions of lemma 4.3

$${}^c\mathcal{D}_{a+}^\alpha \varphi(x) = \mathcal{D}_{a+}^\alpha \varphi(x) \tag{4.26}$$

if and only if  $\varphi$  has an  $n$ -fold zero at  $a$ , i.e., if and only if

$$\delta^j \varphi(a) = 0, \quad j = 0, 1, \dots, n - 1 \tag{4.27}$$

The proof is straightforward.

Now, it is known [8, theorem 2.2] that if  $\Re(\alpha) \geq 0$  and  $\alpha \notin \mathbb{N}_0 = \{0, 1, 2 \dots\}$  such that  $n = [\Re(\alpha)] + 1$ , then

$${}^c\mathcal{D}_{a+}^\alpha \varphi(a) = 0 \quad \text{and} \quad {}^c\mathcal{D}_{b-}^\alpha \varphi(b) = 0 \tag{4.28}$$

This fact disallows us to obtain (for example) a fractional Taylor series using the fractional derivatives evaluated at these points. Otherwise, we can have a series expansion in the form

$$\varphi(x) = \sum_{j=0}^m \frac{({}^c\mathcal{D}_{a+}^\alpha)^j \varphi(a)}{\Gamma(j\alpha + 1)} \left(\log \frac{x}{a}\right)^{j\alpha} + \mathcal{R}_m(a, x) \tag{4.29}$$

where

$$\mathcal{R}_m(a, x) = \frac{({}^c\mathcal{D}_{a+}^\alpha)^{(m+1)} \varphi(\xi)}{\Gamma((m+1)\alpha + 1)} \left(\log \frac{x}{a}\right)^{(m+1)\alpha} \quad \xi \in [a, x] \tag{4.30}$$

is the remainder of the terms in the expansion.

However, we may relax the conditions on  $\varphi$  in corollary 4.1 as in the next result.

**Lemma 4.4**

Let  $\Re(\alpha) \geq 0$  and  $n = [\Re(\alpha)] + 1$  such that  $\alpha \notin \mathbb{N}_0$  and  $\varphi(x) \in AC_\delta^n[a, b]$ .

More so, suppose that  ${}^c\mathcal{D}_{a+}^\beta \varphi(x)$  is continuous on  $[a, b]$  for some  $\beta \in (\alpha, n)$ .

Then  ${}^c\mathcal{D}_{a+}^\alpha \varphi(x)$  is continuous and  ${}^c\mathcal{D}_{a+}^\alpha \varphi(a) = 0$ .

**Proof**

Using (3.5), we obtain

$${}^c\mathcal{D}_{a+}^\alpha \varphi(x) = \mathcal{J}_{a+}^{n-\alpha} \delta^n \varphi(x) = \mathcal{J}_{a+}^{\beta-\alpha} \mathcal{J}_{a+}^{n-\beta} \delta^n \varphi(x) = \mathcal{J}_{a+}^{\beta-\alpha} {}^c\mathcal{D}_{a+}^\beta \varphi(x) \quad (4.31)$$

Thus,  ${}^c\mathcal{D}_{a+}^\alpha \varphi(x)$  is continuous and  ${}^c\mathcal{D}_{a+}^\alpha \varphi(a) = \mathcal{J}_{a+}^{\beta-\alpha} {}^c\mathcal{D}_{a+}^\beta \varphi(a) = 0$  by (4.28).

This completes the proof of the lemma.

## 4.2 Semigroup Properties of Caputo-Hadamard Operators

We present the first proof of the semigroup properties of Caputo-Hadamard fractional derivatives.

### Theorem 4.2 (semigroup property for Caputo-Hadamard derivatives)

Let  $\varphi(x) \in \mathcal{C}_\delta^{m+n}[a, b]$ ,  $0 < a < b < \infty$ . Moreover, let  $\alpha \geq 0, \beta \geq 0$  such that

$$n - 1 < \alpha \leq n, \quad m - 1 < \beta \leq m \quad \text{and} \quad \alpha + \beta \leq n. \quad \text{Then}$$

$${}^c\mathcal{D}_{a+}^\alpha {}^c\mathcal{D}_{a+}^\beta \varphi(x) = {}^c\mathcal{D}_{a+}^{\alpha+\beta} \varphi(x) \quad (4.32)$$

### Proof

Without loss of generality, let  $m \geq n$ . Thus,  $m = n + k$ ,  $k \in \{0, 1, 2, \dots\}$ . Since  $\alpha + \beta < m + n$ , then by definitions and using semigroup properties for Hadamard fractional integrals (2.69) we have

$$\begin{aligned} {}^c\mathcal{D}_{a+}^\alpha {}^c\mathcal{D}_{a+}^\beta \varphi(x) &= \mathcal{J}_{a+}^{n-\alpha} \delta^n {}^c\mathcal{D}_{a+}^\beta \varphi(x) = \mathcal{J}_{a+}^{n-\alpha} \delta^n \mathcal{J}_{a+}^{m-\beta} \delta^m \varphi(x) \\ &= \mathcal{J}_{a+}^{n-\alpha} \delta^n \mathcal{J}_{a+}^{n+k-\beta} \delta^{n+k} \varphi(x) = \mathcal{J}_{a+}^{n-\alpha} \delta^n \mathcal{J}_{a+}^{n-\beta} \mathcal{J}_{a+}^k \delta^{n+k} \varphi(x) \\ &= \mathcal{J}_{a+}^{n-\alpha} \mathcal{D}_{a+}^\beta \mathcal{J}_{a+}^k \delta^{n+k} \varphi(x) = \mathcal{J}_{a+}^{n-\alpha-\beta} \mathcal{J}_{a+}^\beta \mathcal{D}_{a+}^\beta \mathcal{J}_{a+}^k \delta^{n+k} \varphi(x) \end{aligned}$$

Then using (4.6) with  $y(x)$  taken as  $\mathcal{J}_{a+}^k \delta^{n+k} \varphi(x)$  we obtain

$$\begin{aligned} &{}^c\mathcal{D}_{a+}^\alpha {}^c\mathcal{D}_{a+}^\beta \varphi(x) \\ &= \mathcal{J}_{a+}^{n-\alpha-\beta} \left[ \mathcal{J}_{a+}^k \delta^{n+k} \varphi(x) \right. \\ &\quad \left. - \sum_{j=1}^n \frac{\left( \delta^{n-j} \left( \mathcal{J}_{a+}^{n-\beta} \mathcal{J}_{a+}^k \delta^{n+k} \varphi \right) (a) \right)}{\Gamma(\beta - j + 1)} \left( \log \frac{x}{a} \right)^{\beta-j} \right] \\ &= \mathcal{J}_{a+}^{n-(\alpha+\beta)} \left[ \mathcal{J}_{a+}^k \delta^{n+k} \varphi(x) - \sum_{j=1}^n \frac{\left( \delta^{n-j} {}^c\mathcal{D}_{a+}^\beta \varphi(a) \right)}{\Gamma(\beta - j + 1)} \left( \log \frac{x}{a} \right)^{\beta-j} \right] \end{aligned}$$

$$\begin{aligned}
&= \mathcal{J}_{a+}^{n-(\alpha+\beta)} \left( \mathcal{J}_{a+}^k \delta^{n+k} \varphi(x) \right) \quad \text{by (4.28)} \\
&= \mathcal{J}_{a+}^{n+k-(\alpha+\beta)} \delta^{n+k} \varphi(x) = {}^c \mathcal{D}_{a+}^{\alpha+\beta} \varphi(x)
\end{aligned}$$

This ends the proof.

**Remark 4.1**

The same result cannot be obtained in general if Hadamard fractional derivative were used instead. To verify this, suppose for example we have the function  $\varphi(x) = 1$  with  $\alpha = \frac{2}{3}$ ,  $\beta = 1$ . Thus by definitions, the left hand side gives

$$\mathcal{D}_{a+}^{2/3} \mathcal{D}_{a+}^1(1) = \mathcal{D}_{a+}^{2/3} \delta^1(1) = 0$$

The right hand side would be

$$\mathcal{D}_{a+}^{5/3}(1) = \delta^2 \mathcal{J}_{a+}^{1/3}(1) = \delta^2 \frac{1}{\Gamma\left(\frac{4}{3}\right)} \left(\log \frac{x}{a}\right)^{\frac{1}{3}} \neq 0$$

Where  $\delta = x \frac{d}{dx}$ . However, one can easily see that if the Caputo-Hadamard derivative were used, each side gives 0.

In the next lemma, we give the generalisation of theorem 4.2.

**Lemma 4.5**

For  $\varphi(x) \in C_{\delta}^n[a, b]$ ,  $0 < a < b < \infty$ ,

$${}^c \mathcal{D}_{a+}^{\alpha_1} {}^c \mathcal{D}_{a+}^{\alpha_2} \dots {}^c \mathcal{D}_{a+}^{\alpha_m} \varphi(x) = {}^c \mathcal{D}_{a+}^{\sum_{j=1}^m \alpha_j} \varphi(x) \tag{4.33}$$

Where  $\alpha_j \geq 0$ ,  $n_{j-1} < \alpha_j \leq n_j$  and  $\sum_{j=1}^m \alpha_j \leq n \forall j = \{1, 2, \dots, m\}$ .

**Proof**

The proof follows immediately from theorem 4.2 and using mathematical induction.

**Theorem 4.3**

Let  $\varphi(x) \in C_{\delta}^n[a, b]$ ,  $0 < a < b < \infty$  and  $\alpha \in \mathbb{C}$ ,  $\beta \in \mathbb{C}$  such that  $\Re(\alpha) \geq 0$ ,  $\Re(\beta) \geq 0$ . Then

$${}^c\mathcal{D}_{a+}^{\alpha} J_{a+}^{\beta} \varphi(x) = J_{a+}^{\beta-\alpha} \varphi(x) \quad \text{and} \quad {}^c\mathcal{D}_{b-}^{\alpha} J_{b-}^{\beta} \varphi(x) = J_{b-}^{\beta-\alpha} \varphi(x) \quad (4.34)$$

**Proof**

$$\begin{aligned} {}^c\mathcal{D}_{a+}^{\alpha} J_{a+}^{\beta} \varphi(x) &= J_{a+}^{n-\alpha} \delta^n J_{a+}^{\beta} \varphi(x) = J_{a+}^{n-\alpha} \delta^n J_{a+}^{n-\beta} J_{a+}^{2\beta-n} \varphi(x) \\ &= J_{a+}^{n-\alpha} \mathcal{D}_{a+}^{\beta} J_{a+}^{2\beta-n} \varphi(x) \end{aligned}$$

Then from (2.7.39) of [2] we obtain

$${}^c\mathcal{D}_{a+}^{\alpha} J_{a+}^{\beta} \varphi(x) = J_{a+}^{n-\alpha} J_{a+}^{\beta-n} \varphi(x) = J_{a+}^{\beta-\alpha} \varphi(x)$$

Observe that theorem 4 is the generalisation of lemma 2.4 (i) of [8] where  $\beta = \alpha$ .

**Lemma 4.6**

Let  $\alpha \in \mathbb{C}$  with  $0 < \Re(\alpha) \leq 1$  and  $k \in \mathbb{N}$ . Let  $\varphi(x) \in AC_{\delta}^n[a, b]$ ,  $0 < a < b < \infty$ .

Then

$$(J_{a+}^{\alpha})^{(k+1)} ({}^c\mathcal{D}_{a+}^{\alpha})^{(k+1)} \varphi(x) = (J_{a+}^{\alpha})^k ({}^c\mathcal{D}_{a+}^{\alpha})^k \varphi(x) \quad (4.35)$$

**Proof**

$$\begin{aligned} (J_{a+}^{\alpha})^{(k+1)} ({}^c\mathcal{D}_{a+}^{\alpha})^{(k+1)} \varphi(x) &= (J_{a+}^{\alpha})^k J_{a+}^{\alpha} {}^c\mathcal{D}_{a+}^{\alpha} ({}^c\mathcal{D}_{a+}^{\alpha})^k \varphi(x) \\ &= (J_{a+}^{\alpha})^k \left( ({}^c\mathcal{D}_{a+}^{\alpha})^k \varphi(x) - ({}^c\mathcal{D}_{a+}^{\alpha})^k \varphi(a) \right) \\ &\quad \left( \text{by (4.17) with } \Phi(x) = ({}^c\mathcal{D}_{a+}^{\alpha})^k \varphi(x) \right) \\ &= (J_{a+}^{\alpha})^k ({}^c\mathcal{D}_{a+}^{\alpha})^k \varphi(x) \\ &\quad \left( \text{since } ({}^c\mathcal{D}_{a+}^{\alpha})^k \varphi(a) = 0 \quad \forall k = 1, 2, 3 \dots \right) \end{aligned}$$

Both theorem 4.2 and lemma 4.5 deal with the reduction of higher fractional order differential systems to lower order systems for Caputo-Hadamard fractional derivatives. However, in some instances it may also be useful to involve the Caputo-Hadamard and the Hadamard differential operator.

**Lemma 4.7**

Let  $\varphi(x) \in C_{\delta}^n[a, b]$  for some  $n \in \mathbb{N}$  and  $0 < \alpha \leq n$ . Then

$$\mathfrak{D}_{a+}^{n-\alpha C} \mathfrak{D}_{a+}^{\alpha} \varphi(x) = \delta^n \varphi(x) \quad (4.36)$$

Where  $\delta = x \frac{d}{dx}$ .

**Proof**

1. If  $\alpha \in \mathbb{N}$ , then by (3.5) and from (2.7.13) of [2], (4.36) becomes

$$\delta^{n-\alpha} \delta^{\alpha} \varphi(x) = \delta^n \varphi(x).$$

2. Otherwise since  $n = [\Re(\alpha)] + 1$ , then by definitions

$$\begin{aligned} \mathfrak{D}_{a+}^{n-\alpha C} \mathfrak{D}_{a+}^{\alpha} \varphi(x) &= \delta^{[\Re(n-\alpha)]+1} \mathcal{J}_{a+}^{[\Re(n-\alpha)]+1-(n-\alpha)} \mathcal{J}_{a+}^{[\Re(\alpha)]+1-\alpha} \delta^{[\Re(\alpha)]+1} \varphi(x) \\ &= \delta^{n-[\Re(\alpha)]+1} \mathcal{J}_{a+}^2 \left( \delta^{[\Re(\alpha)]+1} \varphi(x) \right) \\ &= \delta^{n-([\Re(\alpha)]+1)+2} \mathcal{J}_{a+}^2 \left( \delta^{[\Re(\alpha)]+1} \varphi(x) \right) = \delta^2 \mathcal{J}_{a+}^2 \left( \delta^n \varphi(x) \right) = \delta^n \varphi(x) \end{aligned}$$

## CHAPTER 5

### CONCLUSION

The usual integer-order integrals and derivatives are not enough to handle most of nowadays real-world scientific and engineering phenomena. For this reason and the likes, attention was paid to the 317-year-old fractional calculus and since then, vast researches and publications were made in the field leading to various approaches of analysing and solving real-world problems.

Fractional calculus started to be considered deeply as a powerful tool to reveal the hidden aspects of the dynamics of the complex or hypercomplex systems [9,10,13]. Finding new generalization of the existing fractional derivatives was always a main direction of research within this field. These generalized operators will give us new opportunities to improve the existing results from theoretical and applied viewpoints. Although the works in [2,3,9] played important roles in the development of the fractional calculus within the frame of the Hadamard derivative, nevertheless, vast and vital work in this field is still undone.

When the Caputo-Hadamard fractional derivatives were introduced in [8], not much about the modified derivatives were studied despite the fact that the derivatives have many advantages (as seen in this thesis) over the Hadamard derivatives. As seen in the beginning of the thesis, Hadamard fractional derivatives cannot be used to generalise the FTFC whereas the Caputo-Hadamard derivative works perfectly. The FTFC is then used in

formulating other important results whose applications to Fractional Vector Calculus in the study of Green's theorem, Stoke's theorem and so forth, as well as in the study of anomalous diffusion is a further work. Many non-existent results such as the semigroup properties for the modified derivatives are studied in details.

Some interesting properties of Caputo-Hadamard derivatives allow us to formulate some important results. Among such results is the formulation of FTFC within the frame of this derivative, semigroup properties of Caputo-Hadamard derivative,  ${}^c\mathcal{D}_{a+}^\alpha \varphi(a) = 0$  and so on. The third result for  $\Re(\alpha) \geq 0$ ,  $\alpha \notin \mathbb{N}_0 = \{0,1,2 \dots\}$  and  $n = [\Re(\alpha)] + 1$ , [8, theorem 2.2] disallows us to obtain (for example) a fractional Taylor series using the fractional derivatives evaluated at these points. Otherwise, we can have a series expansion in the form  $\varphi(x) = \sum_{j=0}^m \frac{({}^c\mathcal{D}_{a+}^\alpha)^j \varphi(a)}{\Gamma(j\alpha+1)} \left(\log \frac{x}{a}\right)^{j\alpha} + \mathcal{R}_m(a, x)$  with remainder  $\mathcal{R}_m(a, x) = \frac{({}^c\mathcal{D}_{a+}^\alpha)^{(m+1)} \varphi(\xi)}{\Gamma((m+1)\alpha+1)} \left(\log \frac{x}{a}\right)^{(m+1)\alpha}$   $\xi \in [a, x]$ . However, we have seen that the condition on the function  $\varphi$  may be relaxed. Lastly, for  $\varphi(x) \in C_\delta^n[a, b]$ ,  $0 < a < b < \infty$ , and by the semigroup property of the Caputo-Hadamard derivative (4.32), we can have the generalisation  ${}^c\mathcal{D}_{a+}^{\alpha_1} {}^c\mathcal{D}_{a+}^{\alpha_2} \dots {}^c\mathcal{D}_{a+}^{\alpha_m} \varphi(x) = {}^c\mathcal{D}_{a+}^{\sum_{j=1}^m \alpha_j} \varphi(x)$ , where  $\alpha_j \geq 0$ ,  $n_{j-1} < \alpha_j \leq n_j$  and  $\sum_{j=1}^m \alpha_j \leq n \forall j = \{1, 2, \dots, m\}$ .

The research in this thesis has been published in Advances in Difference Equations journal of Springer Open Access database (see appendix j for a sample page).

## REFERENCES

- [1] **ANASTASIO, T. J.** (1994), The Fractional-order Dynamics of Brainstem Vestibulo Oculomotor Neurons, *Biol. Cybernet.* Vol 72. No. 1.
- [2] **BUTZER, P. L., KILBAS, A. A., TRUJILLO J. J.** (2002), Compositions of Hadamard-type fractional integration operators and the semigroup property, *J. Math. Anal. Appl.* 387-400. Vol. 269.
- [3] **BUTZER, P. L., KILBAS, A. A., TRUJILLO J. J.** (2002), Mellin transform analysis and integration by parts for Hadamard-type fractional integrals, *J. Math. Anal. Appl.* 1-15. Vol. 270.
- [4] **CHANGPIN, L. A., DELIANG, Q., YANGQUAN, C.** (2011), On Riemann-Liouville and Caputo derivatives, *Hindawi Publishing Corporation Discrete Dynamics in Nature and Society*, 15pages. Vol. 2011. No. 562494.
- [5] **CHANGPIN, L. A., WEIHUA, D.** (2007), Remarks on fractional derivatives, *Applied Mathematics and Computation, Science Direct*, 777-784. Vol. 187.
- [6] **DAVID, U.** (2008), Fractional Taylor Series for Caputo Fractional Derivatives: Construction of Numerical Schemes, *Dpto. de Matematica Aplicada. Facultad de CC. Quimicas. Universidad Complutense de Madrid. Spain.*
- [7] **ELIANA, C. G., DE OLIVEIRA, E. C.** (2013), Fractional versions of the fundamental theorem of calculus, *Applied Mathematics, Scientific research*, 23-33. Vol. 4.

- [8] **JARAD, F., BALEANU, D. A., ABDELJAWAD, T. M.** (2012), Caputo-type modification of the Hadamard fractional derivatives, *Advances in Difference Equations, Springer*. 8 pages. Vol. 142.
- [9] **KILBAS , A. A.** (2001), Hadamard-type fractional calculus, *J. Korean Math. Soc.*, 1191–1204. Vol. 38. No. 6.
- [10] **KILBAS, A. A., SRIVASTAVA, H. H., TRUJILLO J. J.** (2006), *Theory and applications of fractional differential equations*, Elsevier B.V.
- [11] **LAVOIE, J. L., OSLER, T. J., TREMBLAY, R.** (1976), Fractional Derivatives and Special Functions, *SIAM Review*. Vol. 18. No. 2.
- [12] **OLDHAM, K. B., SPANIER, J.** (1970), The Replacement of Fick's Law By a Formulation Involving Semi-differentiation, *J. Electroanal. Chem. and Interfacial Electrochem.* 331–341. Vol. 26.
- [13] **PODLUBNY, I.** (1999), *Fractional differential equations*, Academic Press, San Diego.
- [14] **ROBERT, G. B., SHERBERT, D. R.** (2000), *Introduction to real analysis (third edition)*, John Wiley & Sons Inc.
- [15] **ROUSE, P. E.** (1953), The Theory of the Linear Viscoelastic Properties of Dilute Solutions of Coiling Polymers, *J. Chem. Phys.* 1272–1280. Vol. 21.
- [16] **SAMKO, S. G., KILBAS, A. A., MARICHEV, O. I.** (1993), *Fractional integrals and derivatives: theory and applications*, Gordon and Breach Science Publishers, OPA (Amsterdam) B.V.
- [17] **SCOTT BLAIR, G. W.** (1947), The Role of Psychophysics in Rheology, *J. Colloid Science.* 21–32. Vol. 2.
- [18] **STIASSNIE, M.** (1979), On the Application of Fractional Calculus for the Formulation of Viscoelastic Models, *Appl. Math. Modelling.* 300–302. Vol. 3.
- [19] **TARASOV, V. E.** (2008), Fractional vector calculus and fractional Maxwell's equations, *Annals of Physics.* 2756-2778. Vol. 323.

## Appendix J: Publication

Gambo et al. *Advances in Difference Equations* 2014, 2014:10  
<http://www.advancesindifferenceequations.com/content/2014/1/10>

 **Advances in Difference Equations**  
a SpringerOpen Journal

RESEARCH

Open Access

# On Caputo modification of the Hadamard fractional derivatives

Yusuf Y Gambo<sup>1,2</sup>, Fahd Jarad<sup>3\*</sup>, Dumitru Baleanu<sup>2,4,5</sup> and Thabet Abdeljawad<sup>2,6</sup>

\*Correspondence: [fjarad@thk.edu.tr](mailto:fjarad@thk.edu.tr)

<sup>3</sup>Department of Logistics Management, Faculty of Management, University of Turkish Aeronautical Association, Etimesgut, Ankara, 06790, Turkey  
Full list of author information is available at the end of the article

### Abstract

This paper is devoted to the study of Caputo modification of the Hadamard fractional derivatives. From here and after, by Caputo-Hadamard derivative, we refer to this modified fractional derivative (Jarad *et al.* in *Adv. Differ. Equ.* 2012:142, 2012, p.7). We present the generalization of the fundamental theorem of fractional calculus (FTFC) in the Caputo-Hadamard setting. Also, several new related results are presented.

**Keywords:** Caputo-Hadamard fractional derivatives; fundamental theorem of fractional calculus

## Appendix K: Sample List of Notations

### NOTATIONS

$I_{a+}^{\alpha}, I_{b-}^{\alpha}$	Riemann-Liouville fractional integrals.
$D_{a+}^{\alpha}, D_{b-}^{\alpha}$	Riemann-Liouville fractional derivatives.
${}^cD_{a+}^{\alpha}, {}^cD_{b-}^{\alpha}$	Caputo fractional derivatives.
$\mathcal{J}_{a+}^{\alpha}, \mathcal{J}_{b-}^{\alpha}$	Hadamard fractional integrals.
$\mathcal{D}_{a+}^{\alpha}, \mathcal{D}_{b-}^{\alpha}$	Hadamard fractional derivatives.
$\mathcal{J}_{0+, \mu}^{\alpha}, \mathcal{J}_{-, \mu}^{\alpha}$	Hadamard-type fractional integrals.
$\mathcal{D}_{0+, \mu}^{\alpha}, \mathcal{D}_{-, \mu}^{\alpha}$	Hadamard-type fractional derivatives.
${}^c\mathcal{D}_{a+}^{\alpha}, {}^c\mathcal{D}_{b-}^{\alpha}$	Caputo-Hadamard fractional derivatives.

## Appendix L: Sample Curriculum Vitae

### CURRICULUM VITAE

#### PERSONAL INFORMATION

Surname, Name: GAMBO, Yusuf Ya'u

Nationality: Nigerian (NG)

Date and Place of Birth: 11 March 1987, Kano

Marital Status: Single

Phone: +234 80 65899446, +90 5380301371

Email: [yygambo@gmail.com](mailto:yygambo@gmail.com)

#### EDUCATION

Degree	Institution/Qualification	Year of Graduation
MSC	Çankaya University, Turkey Mathematics and Computer Science	2014
BSC	Bayero University, Nigeria Mathematics	2011
High School	GSS Sheka Kano, Nigeria	2005

## WORK EXPERIENCE

Year	Place	Enrolment
2012	Kano State Polytechnic	Part Time Lecturer
2010-Present	Algadong IT Solutions	Consultant
2011-2012	Federal Ministry of Environment Abuja	Computer Analyst

## CONFERENCES

Date	Place
13-14 June 2013	8th Ankara Mathematics Day, Turkey
23-26 March 2010	20th Colloquium of the Nigerian Association of Mathematical Physics, Nigeria

## PUBLICATION

Gambo et al.: On Caputo modification of the Hadamard fractional derivatives. *Advances in Difference Equations* 2014, 2014:10

## FOREIGN LANGUAGES

Advanced English, Elementary Turkish

## HOBBIES

Watching movies, conversation, developing new concepts, tour.