

**PASSIVE DESIGN GUIDELINE FOR HOT HUMID CLIMATE IN LIBYA:  
LESSONS FROM PAST, VISIONS FOR FUTURE**

**EMAN SASI**

**February 2019**

PASSIVE DESIGN GUIDELINE FOR HOT HUMID CLIMATE IN LIBYA:  
LESSONS FROM PAST, VISIONS FOR FUTURE

A THESIS SUBMITTED TO  
THE GRADUATE SCHOOL OF NATURAL AND APPLIED SCIENCES OF  
ÇANKAYA UNIVERSITY

BY

EMAN ATTI YOUSIF SASI

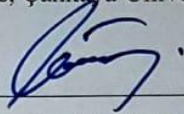
IN PARTIAL FULFILLMENT OF THE REQUIREMENTS FOR THE  
DEGREE OF  
DOCTOR OF PHILOSOPHY  
IN  
THE DEPARTMENT OF  
INTERIOR ARCHITECTURE

February 2019

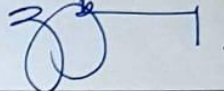
Title of the Thesis: **PASSIVE DESIGN GUIDELINE FOR HOT HUMID CLIMATE IN LIBYA:LESSONS FROM PAST, VISIONS FOR FUTURE**

Submitted by: **Eman Attia Yousif Sasi**

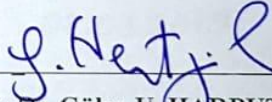
Approval of the Graduate School of Natural and Applied Sciences, Çankaya University.

  
Prof. Dr. **Can ÇOĞUN**  
Director

I certify that this thesis satisfies all the requirements as a thesis for the degree of Doctor of Philosophy.

  
Prof. Dr. **Zühal ÖZCAN**  
Head of Department

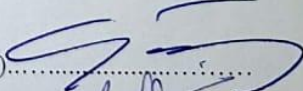
This is to certify that we have read this thesis and that in our opinion it is fully adequate, in scope and quality, as a thesis for the degree of Doctor of Philosophy.

  
Assoc. Prof. Dr. **Gülsu U. HARPUTLUGİL**  
Supervisor


**Examination Date:07.02.2019**

**Examining Committee Members**

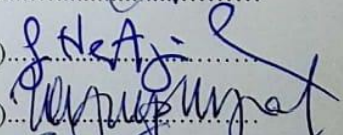
Prof. Dr. Gülser Çelebi

(Çankaya Univ.).....

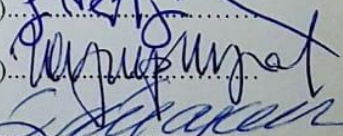
Prof. Dr. Soofia T. ELÍAS ÖZKAN

(METU Univ.).....

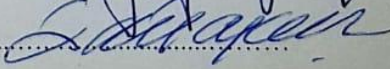
Assoc. Prof. Gülsu U. HARPUTLUGİL

(Çankaya Univ.).....

Assoc. Prof. Dr. Zeynep UYSAL ÜREY

(Çankaya Univ.).....

Assoc. Prof. Dr. İdil AYÇAM

(Gazi Univ.).....

### STATEMENT OF NON-PLAGIARISM

I hereby declare that all information in this document has been obtained and presented in accordance with academic rules and ethical conduct. I also declare that, as required by these rules and conduct, I have fully cited and referenced all material and results that are not original to this work.

Name, Last Name: Nidal AGFIAR

Signature



Date

: 07.03.2019

## ABSTRACT

### **PASSIVE DESIGN GUIDELINE FOR HOT HUMID CLIMATE IN LIBYA: LESSONS FROM PAST, VISIONS FOR FUTURE**

Eman SASI

Department of Interior Architecture

Supervisor: Assoc.Prof. Dr. Gülsu U. HARPUTLUGİL

February 2019

Nowadays contemporary housing in Libya has suffered from problematic issues of high energy consumption and lack of meeting social needs. Therefore this study aims to solve the problems of Contemporary housing by set solutions as guideline for sustainable design of passive housing in hot humid region. The methodology of this study depended on ; first questionnaire that have given to people who have living in contemporary and traditional housing in terms of identify their problem and future needs , second case study on contemporary housing for people who has experience of living in two kinds of housing: traditional and contemporary housing . The significance of the result of this study will add to the knowledge sustainable guidelines for passive housing in hot humid region which did not found in previous studies.

**Keywords:** Contemporary housing- passive housing- Traditional housing - Hot humid region high -energy consumption

## ÖZ

### LİBYA'DA SICAK NEMLİ İKLİM İÇİN PASİF TASARIM KILAVUZU: GEÇMİŞDEN DERSLER, GELECEK İÇİN VİZYONLAR

Eman Sasi

İç Mimarlık Bölümü

Danışman: Doç. Dr. GÜLSU U.HARPUTLUGIL

Şubat 2019

Günümüzde Libya'daki çağdaş konutlar, yüksek enerji tüketimi ve sosyal ihtiyaçların karşılanmasındaki sorunlardan olumsuz şekilde etkilenmiştir. Bu nedenle bu çalışma, sıcak nemli bölgelerde pasif konutların sürdürülebilir tasarımına rehberlik eden çözümler üreterek çağdaş konut sorunlarının çözülmesini amaçlamaktadır. Bu çalışmanın metodolojisi, geleneksel ve çağdaş konutlarda yaşayan insanların kimlik problemlerini ve gelecek ihtiyaçlarını soruşturan bir anketi içermektedir. İkinci olarak ise geleneksel ve çağdaş konutlar olmak üzere iki tip konutta da yaşama deneyimi olan insanların çağdaş konut ihtiyaçları üzerine bir örnekleme çalışması yapılmaktadır. Bu çalışmanın sonucunun önemi, önceki çalışmalarda araştırılmayan sıcak nemli bölgedeki pasif konutlar için sürdürülebilir rehberler bilgisine katkıda bulunmasıdır.

**Anahtar Kelimeler:** çağdaş konut - pasif konut - geleneksel konut - sıcak nemli bölge yüksek enerji tüketimi

## AKNOWLEDGEMENTS

I would like to express my deepest gratitude to my advisor assoc. Prof. Dr Gülsu U. HARPUTLUGİL for her guidance which helped during the time of research and writing of the thesis.

Furthermore, sincere thanks go to Prof. Dr Soofia T. ELİAS ÖZKAN and Assoc. Prof. Dr., Zeynep UYSAL ÜREY, Prof. Dr.Gülser Çelebi and Assoc. Prof. Dr. Assoc. Prof. Dr. İdil AYÇAM ,for their constant support, and assistance and encouragement.

Finally my gratefulness' goes to my husband Nidal ,my children, my mother in law, and my siblings, for all their love, motivation and kind support.

## TABLE OF CONTENTS

<b>STATEMENT OF NON PLAGIARISM</b> .....	iii
<b>ABSTRACT</b> .....	iv
<b>ÖZ</b> .....	v
<b>ACKNOWLEDGMENTS</b> .....	vi
<b>TABLE OF CONTANTS</b> .....	vii
<b>1. INTRODUCTION</b>	
1.1. Overview.....	1
1.2. Research Problem .....	2
1.3. The aim of the study .....	2
1.4. Research Methodology .....	3
1.5. Structure of the study .....	4
<b>2. LITERATURE REVIEW</b>	
<b>2.1. Literature review</b> .....	7
2.1.1. Sustainable approach in developed countries .....	8
2.1.2. Sustainable approach in Arab countries .....	12
2.1.3. Literature of sustainable housing in Libya .....	15
2.1.3. 1. Status of housing in Libya.....	15
2.1.3.2. Sustainable approach in Libya .....	15
2.1.3.3. Plans to solve the environmental issue in housing .....	18
<b>2.2. Description the features of the courtyard and local materials</b> .....	23
2.2.1. Description traditional courtyard housing .....	23
2.2.2. Description of the features of using local materials.....	27
2.2.3. How to use local materials in contemporary life by Hassan Fathy and Rasem Badran .....	29
<b>3. METHODOLOGY</b> .....	32
<b>3.1. Questionnaire</b> .....	34
3.1.1. Discussion and analysis .....	36
<b>3.2. Case study housing</b> .....	52
3.2.1. Background of the case study area .....	52
3.2.2. Case Study House one.....	56
3.2.2.1. Description of the building; .....	56
3.2.2.2. Building analyses .....	56
3.2.2.3. Result according to the users' answer .....	61
3.2.3. Case Study House two .....	65
3.2.3.1. Description of the building .....	65

3.2.3.2. Building analyses .....	65
3.2.3.3. Result according to the users' answer .....	69
3.2.4. Case Study House three .....	73
3.2.4.1. Description of the building .....	73
3.2.4.2. Building analyses .....	74
3.2.4.3. Result according to the users' answer .....	78
3.2.4. Conclusion of case study housing .....	81
<b>4. DESIGN GUIDELINE.....</b>	<b>87</b>
<b>4.1. Structure of the Solutions.....</b>	<b>87</b>
4.1.1. The role of courtyard .....	88
4.1.2. Traditional thermal mass materials .....	88
4.1.3. Air (flow) crossing in building .....	88
<b>4.2. Design a model.....</b>	<b>89</b>
4.2.1. Design a model for future contemporary housing.....	89
4.2.1.1. Design a model for Detached house .....	89
4.2.1. 2. Design a model for Apartments .....	97
4.2.2. <b>Design a model for existing housing</b> .....	109
4.2.2.1. Design a model for existing Traditional housing .....	109
4.2.2.2. Design a model for existing Apartments and detached house .....	111
<b>4.3. Providing water</b> .....	114
<b>4.4. Summary of solutions related to building envelop.....</b>	<b>115</b>
<b>4.5. Guidelines for designing passive housing in hot hummed climate.....</b>	<b>119</b>
<b>4.6. Example of guidelines for housing</b> .....	127
<b>5. CHAPTER FIVE; CONCLUSION .....</b>	<b>136</b>
<b>5.1. Discussion.....</b>	<b>136</b>
<b>5.2. Result .....</b>	<b>139</b>
5.2.1. Result in Questionnaire .....	139
5.2.2. Result in case study housing .....	140
5.2.3. Result of design guideline.....	141
<b>5.3. Recommendation .....</b>	<b>142</b>
<b>REFERENCE .....</b>	<b>143</b>
<b>APPENDIX .....</b>	<b>148</b>
A. <b>Appendix A : Research Questionnaire.....</b>	<b>148</b>
B. <b>Appendix B: Result of Questionnaire.....</b>	<b>161</b>
C. <b>Appendix C: Questionnaire analyses .....</b>	<b>174</b>
D. <b>Appendix D: Final result of Questionnaire.....</b>	<b>207</b>
E. <b>Appendix E: Type of Questions of case study housing in DERN- city.....</b>	<b>213</b>
F. <b>Appendix F: Comparing between traditional and contemporary housing.</b>	221
G. Curriculum Vitae.....	223

## LIST OF TABLES

### TABLES

Table 2.1	Example of low energy housing .....	9
Table 2.2	Science House .....	10
Table 2.3	Example of sustainable solutions in Masdar City.....	13
Table 2.4	Brief descriptions of types of traditional housing in Libya.....	16
Table 2.5	Proposed sustainable solutions of previous studies in Libya .....	20
Table 3.1	Information related to the houses and owners .....	35
Table 3.2	Cooling system.....	37
Table 3.3	Ventaltion system.....	39
Table 3.4	Heating system .....	41
Table 3.5	Lighting system.....	43
Table 3.6	Privacy system.....	46
Table 3.7	Water system.....	48
Table 3.8	Comparison type between Traditional House and contemporary housing	62
Table 3.9	Comparison type between Traditional House and contemporary housing	70
Table 3.10	Comparison type between Traditional House and contemporary housing	79
Table 3.12	Analysis and Result .....	82
Table 4.1	Lessons learned from case study housing 1 .....	91
Table 4.2	Guideline for Low –rise apartments .....	98
Table 4.3	Design model for north faced .....	116
Table 4.4	Design model for south faced .....	118
Table 4.5	Guidelines for designing passive housing.....	119
Table 4.6	Suggested a house for one family.....	127
Table 4.7	Key of figure 4.55 .....	129
Table 4.8	Key of figure 4.57 .....	130
Table 4.9	Key of figure 4.59.....	131

## LIST OF FIGURES

Figure 1.1	Structure of the study .....	6
Figure 2.1	Passive House Ebner .....	12
Figure 2.2	Masdar –City example.....	13
Figure 2.3	Libyan housing issues .....	18
Figure 2.4	Traditional house in Tripoli .....	22
Figure 2.5	Contemporary house in Tripoli .....	22
Figure 2.6	Underground house in Gharyan .....	22
Figure 2.7	Contemporary house in Gharyan.....	23
Figure 2.8	Traditional house in Ghadames .....	23
Figure 2.9	Contemporary house in Ghadames .....	23
Figure 2.10	AL MSHRABEA designed and Transform the courtyard .....	26
Figure 2.11	HASSAN FATHY .....	31
Figure 2.12	RASEM BADRAB; a contemporary architect .....	31
Figure 3.1	Research methodology .....	33
Figure 3.2	Type of housing .....	33
Figure 3.3	Types of factors .....	35
Figure 3.4	Result of the questionnaire .....	36
Figure 3.5	Cooling system.....	36
Figure 3.6	Ventilation system.....	38
Figure 3.7	Ventilation and cooling results.....	38
Figure 3.8	Heating system .....	40
Figure 3.9	Heating system .....	40
Figure 3.10	Windows size of housing .....	42
Figure 3.11	Natural lighting .....	42
Figure 3.12	Natural lighting results .....	42
Figure 3.13	Privacy system analysis 1 .....	44
Figure 3.14	Privacy system analysis 2 .....	44
Figure 3.15	Privacy and safety issues .....	45
Figure 3.16	Privacy and safety needs.....	45
Figure 3.17	Water providing. ....	47
Figure 3.18	Water providing .....	47
Figure 3.19	People needs .....	51
Figure 3.20	Case study area .....	52
Figure 3.21	Map of climatic regions .....	53
Figure 3.22	Temperatures of Derna City.....	53
Figure 3.23	Materials of traditional housing in DERNA- city .....	54
Figure 3.24	Structure of the contemporary building .....	54
Figure 3.25	Location of case study housing .....	55
Figure 3.26	The plan .....	56
Figure 3.27	Section .....	56
Figure 3.28	Ventilation and cooling system 1.....	57
Figure 3.29	Ventilation and cooling system 2.....	58

Figure 3.30	Heating system 1 .....	58
Figure 3.31	Heating system 2 .....	58
Figure 3.32	Lighting system .....	59
Figure 3.33	Privacy of indoor spaces .....	59
Figure 3.34	Security system .....	60
Figure 3.35	Owner`s modification .....	60
Figure 3.36	The plan of case study housing two .....	65
Figure 3.37	Section of case study housing 2 .....	65
Figure 3.38	Ventilation and cooling system 1.....	66
Figure 3.39	Ventilation and cooling system 2.....	66
Figure 3.40	Heating system 1.....	67
Figure 3.41	Heating system 2.....	67
Figure 3.42	Lighting of courtyard .....	67
Figure 3.43	Level of privacy .....	68
Figure 3.44	The form of façade.....	68
Figure 3.45	The plan, Location of the housing .....	73
Figure 3.46	Section of case study housing 3 .....	73
Figure 3.47	Ventilation and cooling 1.....	74
Figure 3.48	Ventilation and cooling 2.....	74
Figure 3.49	Heating system 1.....	75
Figure 3.50	Heating system 2.....	75
Figure 3.51	Heating system 3 .....	75
Figure 3.52	Lighting of the courtyard .....	76
Figure 3.53	Level of Privacy .....	76
Figure 3.54	Safety system .....	77
Figure 3.55	Owner`s modification .....	78
Figure 4.1	Suggested solution type .....	87
Figure 4.2	The Structure of the Suggested Solutions .....	88
Figure 4.3	Air crossing in build.....	89
Figure 4.4	Suggested Solutions for Detached house and Apartments .....	89
Figure 4.5	Wind direction in the city of Derna .....	90
Figure 4.6	Ventilation and cooling .....	90
Figure 4.7	Wind direction .....	90
Figure 4.8	Ventilation and cooling by the stairs .....	91
Figure 4.9	Ventilation and cooling by courtyard 1.....	92
Figure 4.10	Ventilation and cooling by courtyard 2.....	92
Figure 4.11	Lighting solutions in the summer .....	93
Figure 4.12	Example of covered balcony .....	93
Figure 4.13	Example of lighting by windows .....	94
Figure 4.14	Heating and lighting solutions .....	94
Figure 4.15	Kind of heating in the winter.....	95
Figure 4.16	Type of existing solutions .....	95
Figure 4.17	Type of a high fence.....	95
Figure 4.18	Example of covering wall .....	96
Figure 4.19	Example of courtyard .....	96
Figure 4.20	Solution of courtyard .....	96
Figure 4.21	Solutions for Apartments .....	97
Figure 4.22	Low –Rise Apartments in Libya.....	97
Figure 4.23	Solution idea.....	99
Figure 4.24	Plan of design solution .....	99

Figure 4.25	Form of ventilation and cooling in plan and section.....	100
Figure 4.26	Cooling Solutions.....	100
Figure 4.27	Heating Solutions 1.....	101
Figure 4.28	Heating Solutions 2 .....	101
Figure 4.29	Natural lighting and sunshine through wall gaps .....	101
Figure 4.30	Solution of ventilation and lighting .....	102
Figure 4.31	Solution of ventilate indoor spaces .....	102
Figure 4.32	A public courtyard on the ground floor.....	103
Figure 4.33	Example of apartments with private courtyard.....	103
Figure 4.34	Example of apartments with private courtyard.....	104
Figure 4.35	Example I, solution of ventilation .....	105
Figure 4.36	Solution of lighting .....	106
Figure 4.37	Privacy for facades of courtyard .....	107
Figure 4.38	Privacy for facades of courtyard .....	107
Figure 4.39	Possibility of using an atrium instead of courtyard .....	108
Figure 4.40	Analysis illustrates the disadvantages and advantages .....	109
Figure 4.41	Solutions for existing Traditional housing .....	110
Figure 4.42	Solving the problem in case study housing (1) .....	110
Figure 4.43	Solution for existing Detached house and Apartment 1.....	111
Figure 4.44	Solution for existing Detached house and Apartment 2 .....	112
Figure 4.45	Solution for existing Detached house and Apartment 3 .....	112
Figure 4.46	Solution for existing Detached house and Apartment 4 .....	113
Figure 4.47	Solution for existing Detached house and Apartment 5 .....	113
Figure 4.48	Solution for existing Detached house and Apartment 6 .....	113
Figure 4.49	Underground water in DERNA city .....	114
Figure 4.50	The place of ground water in DERNA. ....	114
Figure 4.51	Solutions for north façade .....	116
Figure 4.52	Solutions for south façade .....	118
Figure 4.53	Example of ground floor.....	128
Figure 4.54	Building analyses.....	128
Figure 4.55	Example of first floor.....	129
Figure 4.56	Building analyses.....	130
Figure 4.57	Example of first floor.....	130
Figure 4.58	Section .....	131
Figure 4.59	Section analyses.....	132
Figure 4.60	Kind of guidelines for façade .....	132
Figure 4.61	Kind of guidelines.....	133
Figure 4.62	Kind of guidelines.....	133
Figure 4.63	Role of plant in site.....	134

## LIST OF ABBREVIATIONS

<b>Symbol</b>	<b>Name</b>	<b>Source</b>
<b>PH</b>	Passive House	World symbol
<b>TH</b>	Traditional Housing	Research symbol
<b>DH</b>	Detached House	Research symbol
<b>AP</b>	Apartment	Research symbol
<b>CSH.1</b>	Case study Housing one	Research symbol
<b>CSH.2</b>	Case study Housing two	Research symbol
<b>CSH.3</b>	Case study Housing three	Research symbol

## **CHAPTER I**

### **INTRODUCTION**

#### **Overview**

Nowadays, most developed countries are concerned with environmental issues of building; they consider sustainable strategy to solve many of these problems. The advanced strategies of sustainable approaches deal with two issues, namely of high energy consumption and the impact of energy emissions. Most developed countries have planned to solve these problems by reducing energy consumption or reducing energy emissions to nearly zero emissions in buildings [50]. These plans aim to reduce energy and reduce the impact on the environment as well as provide buildings with suitable indoor environments, social needs and suitable costs. Relating to the research example of a hot humid zone in Libya, contemporary housing has suffered from environmental, social and economic problems. However, in the past, people succeeded in designing sustainable housing consistent with their local environments and needs. Due to industrial progress and population growth in Libya, most contemporary housing design did not consider the local environment or the needs of people, which led to suffering and many problems for people. Today resulting to world progress which climes for more sustainable solutions which, aim to provide a suitable building for the local environment especially in the poor and hot countries. This study offers a sustainable solution of nearly-zero energy housing in hot humid regions by relying on the lessons learned from traditional courtyard housing. This research, in a general view, will reduce energy consumption and environmental impacts as well as provide a comfortable indoor environment, meet social needs and be low cost. These are demands in third-world countries, especially regarding issues of political change and a harsh climate.

## **Research Problem**

As a result of the negative impact on our environment, most developed countries aim to arise sustainable strategies for built environments in the future. For instance, the United Kingdom aims to minimize any environmental impact by designing low emission buildings or nearly-zero emission buildings, while the United States aims to reduce dependence on fossil based energy by providing renewable energy from solar and wind sources to achieve the goal of low energy buildings. As a result, most developed countries have already a plan by 2030 to design low energy building or nearly zero energy[50].

Arab countries, such as the United Arab Emirates becomes the eighth country out of 150 countries interests in the construction of sustainable buildings aimed to achieve the goal of reducing carbon dioxide emissions and preserving oil wealth for next generations. However, it is the richest Arab country which is going to be built and has large oil reserves. As a result, it is the first sustainable city in the world by 2030 [54].

The Arab world, including Libya, has suffered from harsh climates. These climates are very hot and dry in the south and hot and humid in the north. In the past, the most traditional Libyan houses had unique features of sustainable solutions which helped people to live comfortably with their local environment and their social needs. Thus, housing reflected their identity, culture, and needs. Unfortunately, after urbanization due to population growth, urban expansion and economic development, everything has changed in the built up environments of cities, especially in housing due to following the contemporary world in their experience and their characters of form, without consideration of any differences in climate, local environment and social culture. As a result, most contemporary housing is facing the problems of first not meeting the social and cultural needs of the Libyan community, which helps people to modify the original features associated with the housing to meet their needs, [45]. Secondly, most contemporary housing depends on air-conditioning, which consumes huge amounts of energy. Finally, during the civil war of 2011, most Libyan homes had

suffered hardship and experienced difficulties accessing electricity, water resources and other issues which this study aims to identify.

### **Research Aim**

This research aims to find the passive solution to contemporary housing in hot humid regions by using an advanced sustainability strategy of passive buildings. This strategy aims to solve the environmental, social and economic problems of the contemporary house with the lessons learned from traditional courtyard housing in hot humid climate in Libya.

### **Hypotheses**

With a possible future scenario for Libya to follow advanced sustainable strategies in designing housing in future, it is will know that; the traditional courtyard housing type still being desired by people living now therefore by this research Identifying the housing environmental, social and economic problems will be reduced them by Lessons learned from traditional courtyard housing being sufficient to achieve the goal of passive housing

### **Research Methodology**

The study will focus on residential buildings located in hot humid regions in Libya as the main examples of this study. So this study has two main step (1) Data collection and (2) field survey.

### **The Questionnaire;**

The Questionnaire is given to a sample of people who have experience of living in both traditional and contemporary houses. The questions are of three types: first, questions that focus on environmental problem which examine the nature of ventilation, cooling, heating and lighting systems of housing. Second, questions examine the value of privacy and safety, followed thirdly by questions about the economic problems of water and electricity shortages. All these questions help to

identify the most important problems that users or owners are experiencing in contemporary and traditional housing.

### **Field Survey;**

A field survey on housing in hot humid regions is performed. The type of housing will include traditional and contemporary houses. The number of examples in the case study housing was six houses, three of which are traditional and the other three being contemporary. Houses were selected from people with experience of living in both traditional and contemporary houses as it is important to compare traditional and modern homes according to user's experience.

Data collection of the field for both types of building were done by gathering drawing plans, sections, facades and details, As well as taking pictures of facades.

Beside collection data for demolished traditional houses interview with owner of the houses and pictures were help to allow them available for analysis.

Kind of data analysis;

- Environment data; understanding cooling and heating systems, courtyard ventilation and lighting systems and drawing sketches illustrative of each system
- Social data ; understanding the value of privacy and safety
- Natural materials; understanding types of material.

The research has developed an appropriate solution which is the proposed solution for the future design of housing to achieve the goal of low- or nearly-zero energy housing.

### **Structure of the study**

This study is composed of five chapters: Introduction, Literature Review, Methodology, Solutions, Findings and Recommendations. Each chapter deals with different aspects as seen in Figure one

**Chapter One:** Introduction

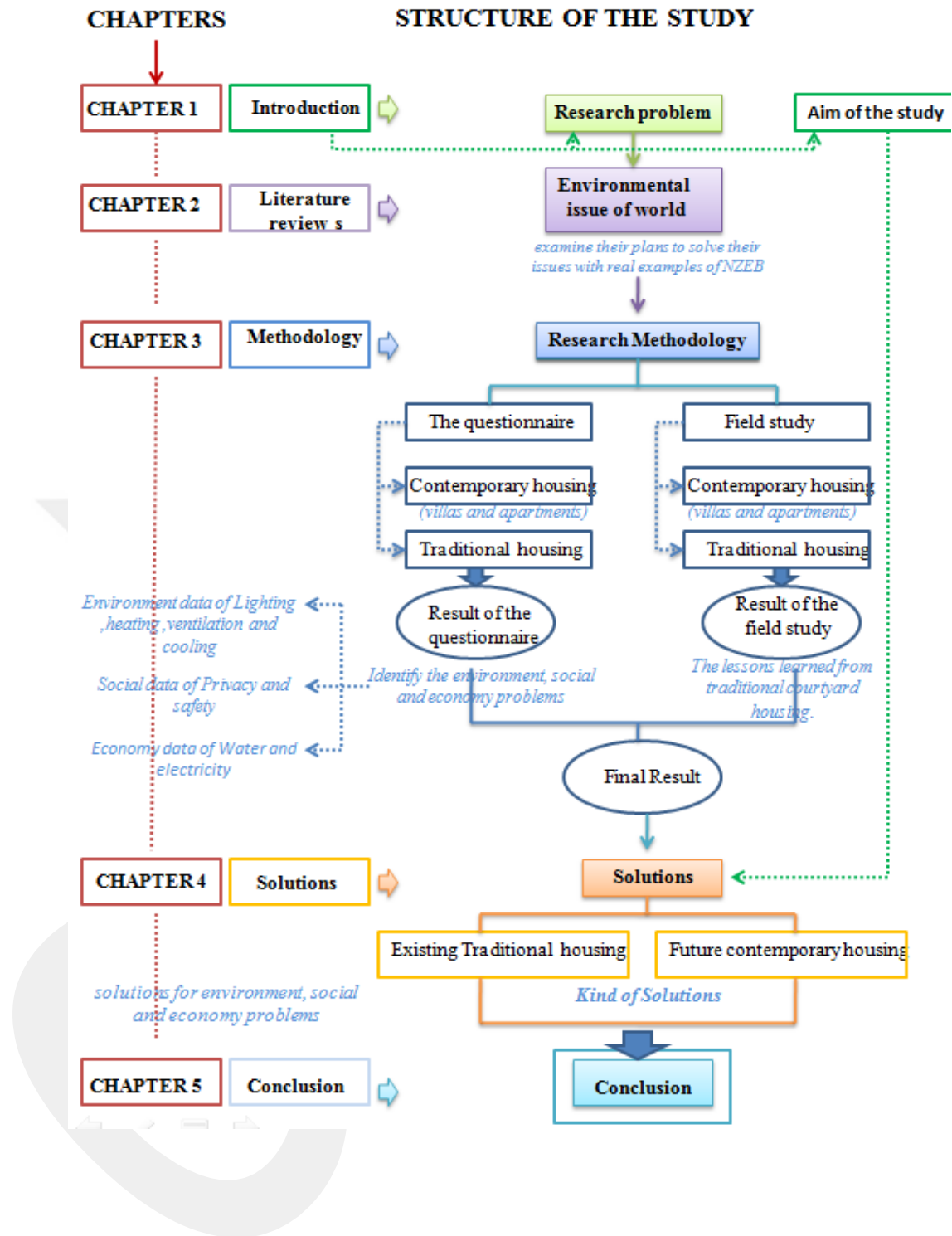
**Chapter Two:** A Literature review including four distinct parts. First, we identify the environmental issue of the advanced world and examine their plans to solve their issues with examples of passive house . In addition, we investigate the

environmental issue of housing in the Arab region with important sustainable solutions occurring as real sustainable + projects. Finally, it is presented the previous studies of contemporary Libyan housing environmental issues and their proposed passive solutions.

**Chapter Three:** The methodology of the study depends on first; the questionnaire identifies the problems facing users or owners in contemporary housing. Second, a field study of six traditional and contemporary houses which focuses on sustainable solutions by analyzing the environmental and social factors that helps to archive the goal of setting a proposed solution passive house. Finally, this chapter presents the findings of the questionnaire and the case study housing as the final results.

**Chapter Four:** Proposed solutions consider two strategies. First, we present solutions for future contemporary housing of detached and apartments that deal with environmental and social solutions regarding current building. Secondly, solutions dealing with existing housing of Traditional courtyard housing, Detached house and Apartments including environmental solutions for windows, balconies and roofs are presented.

**Chapter Five:** This chapter includes an abstract of the research findings, conclusions and recommendations as well as a brief description to achieve a sustainable passive building in Libya in the future by the lessons learned from traditional courtyard housing.



**Figure 1.1:** Structure of the study

## **CHAPTER II**

### **LITERATURE REVIEW**

This chapter will present literature of sustainable building in two area ; developed world and Arab world by identify the building issue and their sustainable plans to solve these problems ,followed by an examination of the main examples that aim to achieve the goals of passive building or low energy building in the future . furthermore, literature review by identify the previous studies of Libya and present the problem of contemporary housing as well as plan to solve these problems, especially in hot humid regions. Finally, due to the traditional courtyard house having unique environmental features and their role of sustainability of courtyards and local materials.

#### **2.1. LITERATURE REVIEW**

Passive design is way of using natural environment and climate to build comfortable and efficient energy building without using mechanical plant(not involve electrical systems) therefore passive design using natural energy for cooling and heating the building. the aim of passive design is providing comfort indoor environment with minimum artificial energy. Principles of passive design aim to achieve the comfort environment and reduce using artificial energy as well as reduce the environment impact. The basic Passive Solar Design Techniques depended on five items; a) using thermal mass. b)Good insulation of building. c)Well-insulated frame of window. d) Building envelop must be an airtight. E) using climate for ventilation and cooling .

Mlecnik, [37] investigated low energy that has been adapted in Belgium and the Netherlands with the aim of being an example for other European countries. For example, the building issue in Europe is such that most buildings consume 40% of primary energy, and as Mlecnik mentioned government endeavoring to develop a plan to conserve energy and reduce emissions. As a result, Europe is attempting to build an low energy building by 2025. Therefore, most studies recommend

that “*focus [be] on buildings with CO<sub>2</sub> emissions and primary energy consumption which are low or equal to zero.*” Moreover, this study discusses the appropriate definition of energy efficiency for Belgium and the Netherlands as well as the definitions in other countries. The methodology of this study depended on an interview method derived from diffusion theory. Then, the study provided questions about nearly-zero energy housing and visibility questions. The study first asked questions about low-carbon and low-energy. Second, it asked questions to experts only (experts from different countries) about the compatibility of low-energy housing development, and finally, for label developers, it asked questions about the latest developments of relevant labels. All the results relied on definitions collected from academic stakeholders and energy efficiency experts. These definitions pertained to low-carbon, low-energy, zero-energy and passive houses. As a result of this study, many definitions were offered by experts in Europe as the following definitions, Moniteur Belge of a low-energy house: “*The total energy demand for space heating and cooling should be limited to 30 kWh/m<sup>2</sup> conditioned floor area.*” The second definition is that of a passive house: “*The total energy demand for space heating and cooling should be limited to 15 kWh/m<sup>2</sup> conditioned floor area. During a pressurization test (according to the NBN EN 13829 norm) with a pressure difference of 50 Pa between inside and outside, the air loss should not be more than 60% of the volume of the house per hour ( $n_{50} \leq 0.6/h$ ).*”[49].


### **2.1.1. Sustainable approach in developed countries**

Most buildings have 30% energy consumption in the UK and 40% in the EU. In fact, the main consumers of energy in homes are heating/cooling, lighting and hot water. These will increase in the future and consume more energy. the net UK carbon account for 2050 is at least 80% lower than the 1990 baseline and from 2016; all new homes must meet low Carbon standard [23]. The report of Erhorn presented examples of nearly zero-energy buildings) at the level of energy performance. These examples were selected by “*the EPBD Concerted Action (EPBD CA) national delegates.*” This report discussed questions of the existence of what kind of nearly zero-energy buildings in the various countries and what kind of renewable energy sources were being used in these buildings in addition to other questions. In addition, the case studies were conducted by authors to evaluate the numbers of

these examples. The projects or examples had different goals. For instance, a number of them were designed as plus energy buildings and others in the Passive House standard to achieve maximum renewable energy. The examples included residential, bank, offices and schools buildings. The outcomes of this report were that 74% of buildings are more energy efficient than buildings designed according to national requirements. In fact, a number of buildings were positive in energy with 50% of buildings using photovoltaic systems and solar thermal panels. More buildings were also using thermal heating from under the ground. The lessons learned show clearly owner satisfaction in most of these examples.

This study presents one of these examples, as shown in Table 2.1 below;


**Table .2.1:** Example of low energy housing [23]

	<b>Low energy housing</b>
<b>Location</b>	 <p>Located in France 21 single-family houses (160 m<sup>2</sup>)</p>
<b>Aim</b>	Low energy housing
<b>Providing energy</b>	The flat roofs are covered with solar panels that provide energy for each house.
<b>Ventilation and cooling</b>	<ul style="list-style-type: none"> <li>• The roof is shaded with solar panels, which helps to reduce heat accumulation.</li> <li>• Separate buildings allow air to move between buildings as well as to help the solar panels work effectively.</li> </ul>
<b>Heating</b>	<ul style="list-style-type: none"> <li>• A good orientation of the house</li> <li>• Ground heat pump; by storing the heat in the summer and using it in the winter</li> </ul>

Buildings consume 40% of the primary energy, and in the United States, most buildings consume 70% electricity. The problem is that commercial buildings consumed double between 1980 and 2000 and this issue will increase to approximately 50% of electricity consumption by 2025. As a consequence this world issue will increase in the coming years if does not decompose environmentally [23].

**Sustainable Examples in developed countries :** The DOE aims to learn from the lessons of seven buildings which are a guide for future studies. The Science House in Minnesota designed by the European Council for an Energy-Efficient Economy (ECEE); The paper of the Weidt Group [43], presented the Science House as a low Energy Building which has the goal of reducing energy consumption and answering the question of *“How much building and power generation can we build with the given budget?”* It was also presented as zero emission housing. The basic design strategies in the building being used to achieve this goal are day lighting, passive solar, PV panels, and pump designs using natural sources of heat. This paper first discusses the parameters used in this design process, and second, how the goal of low Energy housing was achieved. Therefore, such buildings need more generated energy or good conservation of energy to achieve this goal, but the challenge is not easy to meet, as the Weidt Group mentions: *“Even with residential buildings, zero net energy goals have not been easily met “* with the design process using the tools of DOE-2, which aims to improve building performance as follows: *“Simulating the energy performance of each isolated energy efficiency strategy”* [43]. The findings are that; first, the energy generated on the site exceeds consumption. Second, the real design needs an energy budget in the early design process. Thirdly, using a monitoring system discovers any problems in the stages of the design process as well as helps the DOE-2 model to discover any change in the building’s operation.

**Table 2.2:** Science House, [43]

Solutions	Kind of solution	Analyses
<b>Building orientation</b>	Good orientation to south and north facades	The building faces the north and south by longer facades.
<b>Heating</b>	<p>Glasses facades</p>  <p>South facades</p>	<ul style="list-style-type: none"> <li>• Design glass façades which face the south to collect the heat of the sun.</li> <li>• In order not to lose heat of the sun, part of the north façade is tucked into the ground.</li> <li>• Heat pump strategies in the ground help to extract heat for heating the building in the winter, as well as providing hot water.</li> </ul>

<b>Electrical generation</b>	Photovoltaic PV panels on the roof generate electricity.	<ul style="list-style-type: none"> <li>• Generating electricity greater than consumption</li> <li>• The energy generated is 60% greater than consumption.</li> <li>• Using computer monitoring that helps to control the mechanical systems of the entire building.</li> <li>• PV generates 10,000 kWh annually.</li> </ul>
<b>Lighting</b>	There are two windows, one in the north (large windows) and the other in the south (small and high windows) that face each other.	<ul style="list-style-type: none"> <li>• This solution provides effective natural lighting</li> <li>• Using day light reduces electrical loads.</li> </ul>
<b>Ventilation and cooling</b>	Cooling the heat pump system	<ul style="list-style-type: none"> <li>• The heat pump heats and cools the spaces “by exchanging heat with the ground loop” [43]</li> <li>• Natural ventilation to cool the spaces</li> </ul>

Passive House Ebner; It is a residential building type, located in Austria, its size about 216 m<sup>2</sup>. This house was built to achieve the aim of passive house standards so the idea of the building relied on using panels of solar thermal and using environmental materials such as Wood, straw and loam rendering . the elements of evaluation including ; first ; in the housing envelope construction , it was used triple glazing windows, the floor had "50 cm foam glass gravel that fill under a concrete base plate". Moreover is used 70 cm straw bales in the wood frame construction of wall and roof .secondly ; for the housing service systems was used wood-pellet stove to heat the building and solar panels to demand the hot water. Thirdly ; for renewable energy technologies was used wood pellets and solar thermal panels to heat the building .finally ; The satisfaction of the owner is very high. Unfortunately, the cost of building about 300,000 € . as result the challenge of this project was constructed the building by the straw material. Furthermore the improvement of this housing when compared to national requirements buildings was about 42%. And total primary energy about 85.9 kWh/m<sup>2</sup>.year and total CO<sub>2</sub> emissions about 10.4 kg/m<sup>2</sup>year.



**Figure 2.1:** Passive House Ebner

### **2.1.2. Sustainable approach in Arab world**

As a result of the environmental impact and global warming, the UAE aims to design sustainable projects to achieve low emissions energy (carbon), and aims to increase non-oil revenues in the economy from approximately 40% to over 60%. As a result of environmental pollution and increasing carbon emissions, as well as following the world with scientific progress in the field of renewable energy research, the UAE comes at the forefront of Arab countries concerned with sustainable building projects, and it ranks eighth among 150 countries in the list of countries with the largest number of environmentally friendly buildings. The UAE is seeking to design sustainable buildings, sustainable projects, such as Masdar City, which will be completed by 2030. In fact, this city will be the first sustainable city in the world by 2030 [54].



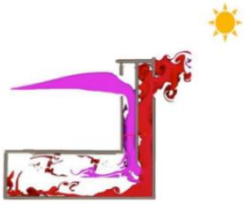
**Sustainable examples in the Arab world :** Example of Masdar City in Abu Dhabi (2008-2030) ;The city was designed by the Masdar Company with the aim of achieving significant profits of trade in the renewable energy and sustainable technologies sector. Masdar City, with an area of 700 hectares, will house 40,000 residents. Its goal is to become the best sustainable city with low-emission energy, low waste energy and provision for the highest quality of life. In fact, it is a world center for renewable energy and clean technology that will prevent environmental impact. The aims of this city include, (1) creating the first unpolluted environment, (2) use of renewable energy, especially solar energy at a production capacity of 10 MW covering an area of 22 hectares, (3) management of carbon and water conservation, and (4) support for economic diversity contributing to the development of the global community, which includes major renewable energy companies and clean technology. The benefit of the city is “the source” of the sun's rays as well, where the electrical generating clean energy using technology installed

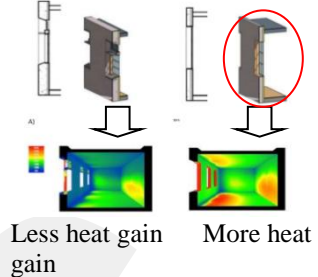
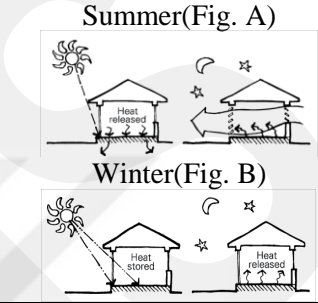

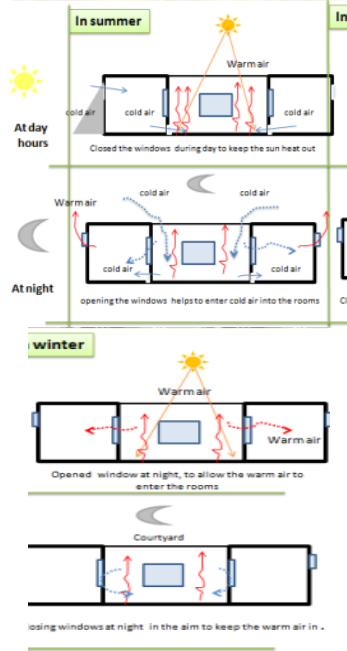
solar panels on the roofs of buildings, as well as owning one of the largest PV installations in the Middle East "Masdar Institute of Science and Technology," a major platform for innovation at the heart of "Masdar City The lessons learned from this example include reductions in energy consumption and an increase in energy efficiency [54].



**Figure 2.2:** Masdar City example; with the International Renewable Energy Agency and Masdar Institute of Science and Technology buildings (Source: Google Images)

**Table 2.3:** Example of sustainable solutions in Masdar City [16]

	Kind of solution	Aim	Analysis	Figure
Lighting	Using wavy facades (undulating balconies) and covering the facades	prevents direct sunlight	An undulating balcony shapes the shadows, while the opening wall prevents direct light to enter the indoor space.	
Ventilation	Using a gallery on the lower floors	Allowing the air to flow into the gallery on the ground floor to ventilate the indoor space	The gallery prevents direct sun light but allows air flows on the lower floor. It also protects the facades from accumulating solar heat.	
Ventilation and cooling	a. Use of wind towers b. Use of openings in the roofs	a. Ventilation and cooling of the interior space b. Allowing hot air out thereby ventilating the space	This allows the cool wind to enter the space and hot air to rise because the air moves from a low pressure to a high pressure.	

Role of wind towers in	Cold air enters the wind tower and replaces the hot air on the lower floor while the hot air rises to the top of the tower and exits. This strategy is used for ventilation and cooling indoor spaces, especially with high towers facing the direction of cold winds.		
Lighting	Protecting the south windows	Prevents direct sunlight thereby preventing heat accumulation	The use of small windows on the south side with curtains prevents direct solar heat from entering the spaces. 
Thermal mass	Using local materials	Provide thermal comfort for heating and cooling systems	The capacity of the materials to store the heat during the day and release it at night 
Role of thermal mass	In the summer, it helps to keep indoor spaces comfortable by closing the windows during the day and opening them at night in order to release the warm air, as shown in Figure A In the winter, it helps to keep the spaces warm by storing heat during the day and releasing it at night, as shown in Figure B , Reardon (2013)		
Ventilating and cooling	Wind tower	Source of natural ventilation	Wind tower provides cool air for people in the square 
Courtyard	Using two public spaces in the city with landscape	Achieves space with thermal comfort and provides a social space for people to gather	Depends on the air movement between shaded and light areas, which means air moves from low pressure to high pressure zones 

<b>Role of the courtyard</b>	<p>In the summer, at night cool air flows into the rooms through the windows and doors and replaces the hot air which exits through high openings in the walls. During the day when the sun heats the courtyard, the space closing the windows and doors helps to keep the rooms cool.</p> <p>In the winter, during the day the sun heats the courtyard and hot air enters the rooms, which helps to gain heat. At night, keeping the doors and windows closed helps to warm the space.</p>
------------------------------	---

To sum up, this table presents the main aims of the advanced world to solve the environmental issue of buildings in the future by focusing on reducing energy and the impact of carbon emissions, as illustrated here:

### **2.1.3. literature of sustainable housing in Libya**


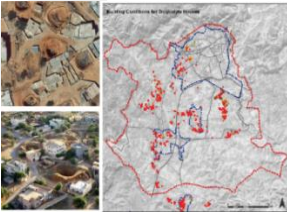




**2.1.3.1. Status of housing in Libya :** Libya has a harsh climate, which is extremely hot dry in the south and hot and humid in the north. In the past, most traditional Libyan houses had unique features of sustainable environmental solutions which helped people to live comfortably with their local environment and meet their social needs. Thus, housing reflected their identity, culture as well as their needs. Unfortunately, after urbanization due to population growth, urban expansion and economic development, everything has changed in the built environment of cities, especially housing due to following the contemporary world in their experience and their characters of form, without considering differences in climate, local environment and social needs, [45]. As a result, most contemporary housing is facing several problems. Firstly, contemporary housing has not met the social and cultural needs of the Libyan community, which helps people to modify the original features associated with the housing to meet their needs. Secondly, a comfortable indoor environment in most contemporary housing depends on air-conditioning, which consumes a huge amount of energy [45]. Finally, during the war in the country, most Libyan homes suffered hardship and experienced difficulties accessing electricity and water resources.

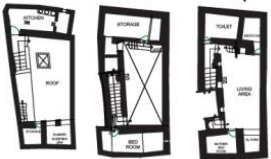
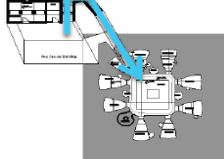
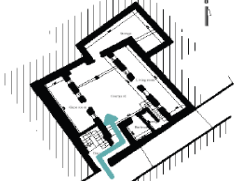

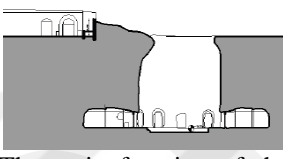
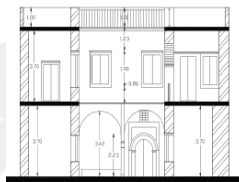





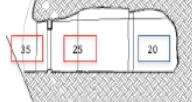
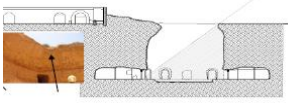
### **2.1.3.2. Sustainable approach in Libya**

To understand the environmental issues in Libya, this study presents the background of various types of housing in the literature and subsequently identifies their environmental and social factors regarding three different types of housing: (i) traditional housing, (ii) Italian colonial housing, and (iii) contemporary housing.

First, the traditional house is divided into different typological, specifically desert houses, which are found in southern Libya, especially compact houses, which have the most appropriate solutions for the problem of the heat of the sun, ferocious winds and the lack of water. These houses are cool in the day and warm at night. The other typology is the mountain house, also known as earth-sheltered houses, being located only in Greian and Al qwasem and which were built by the Berber people [29]. The courtyard house (Housh) is a coastal house. This type of housing is located primarily in coastal cities, such as Darna and Benghazi in the east and Tripoli in the west. This type of housing reflects the culture, heritage and identity of the city from the 16th century to the present. The urban fabric of the old city is characterized by a group of courtyard houses which are separated by public and private spaces. Courtyard houses have an irregular form with a courtyard shaped as a square. Moreover, most houses have one façade that opens out to narrow streets providing shade and facing desired winds. This type of housing reflects the idea of people’s needs for separate private and public spaces Contemporary housing is divided into two types, namely villas and apartments [29].

**Table 2.4:** Brief descriptions of types of traditional housing in Libya [29].

Type	Desert Houses	Mountain Houses (Earth-sheltered dwellings)	Courtyard Houses
Location	 <p>Located in Ghadames, Ghat and other desert cities (it won the best traditional city in the Arab world award in 2016).</p>	 <p>Greian and Al qwasem</p>	 <p>Located in coastal cities, such as Darna and Benghazi in the east and Tripoli in the west.</p>
Urban fabric and streets	 <p>Compact houses without any yards that open onto narrow covered streets with a roof and has some halls that allow air to circulate around.</p>	 <p>Separate houses built by the Berber many years ago</p>	 <p>Compact houses with courtyards that open out onto narrow streets via one face</p>

Plan and entrance	 <p>Most of these compact houses cover a small area. This area has between two and three floors. The entrance is situated on the ground floor due to the need for privacy.</p>	 <p>The house consists of a central courtyard with an area of 100 m<sup>2</sup>. All the rooms (Dar) open onto it deep under the earth.</p>	 <p>Most houses have two floors that are shared with other houses with three adjoining walls. Moreover, it has a semi-regular form with a central courtyard. Each of the rooms opens into the courtyard which works as an outdoor space.</p>
Form	 <p>Most compact housing has two floors. There are no windows inside or outside the house; however, there are many holes in the roof and walls designed to circulate the air.</p>	 <p>The main function of the house is located underground, while the entrance and storage rooms are situated above ground.</p>	 <p>These houses are characterized by a central courtyard that provides shade, cool air and privacy for people.</p>
Character	 <p>Ghadames has a unique character that reflects its identity, culture and the people's needs.</p>	 <p>Mountain houses reflect the types of living in the mountains from ancient times up to now.</p>	 <p>These types of house are found in the coastal region in Libya, which means that they are the most well-known in Libya.</p>
Environmental solutions in traditional houses	 <p>Cool air enters the houses from the covered street through holes in the walls.</p>  <p>Some solutions provide cool air and light in spaces through holes in roofs and walls.</p>	 <p>These rooms are of a length that makes it very cool at the end point.</p>  <p>The courtyard area must be 100 m<sup>2</sup> and the height to width ratio must be 1:1. The aim is to provide shade inside the courtyard.</p>	<p>At night the warm air circulates up and cool air moves down</p> <p>During the day, the shade helps air movement due to pressure zones.</p>

Additionally, in the last four decades, contemporary housing has been constructed in every Libyan city. These houses were designed by a foreign company named Villa. Most have two floors with a garden around them. Moreover, they include high walls in order to provide privacy for residents. However, in the modern form there is no courtyard inside the house and most of the materials are concrete and steel which are used for the roof, columns and floor, while hollow cement blocks are used for the walls [48, p. 174].

Conversely, the issue with this type of housing, as Shawesh indicated, is that *“most, if not all, projects fail to a greater or lesser extent to respond to the needs of the user, particularly where large families are involved. The essential requirements of adequate space are rarely considered. The traditional, culture and social background of the residents are not considered. Climate and local building materials are disregarded”* [48, p. 53]. Furthermore, regarding the housing issue [45]. suggested that the same housing is built in every city, without considering any difference in climate, culture or needs. Foreign experts studied the social life in the capital, Tripoli and applied it to every coastal and desert city. Inadequate funding for housing projects has led to most houses not being completed and in the last two decades, the lack of housing has become a considerable problem facing all Libyan cities, leading to new families building rooms on top of their parents’ homes.



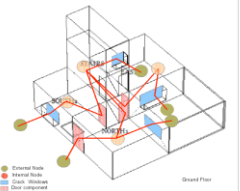


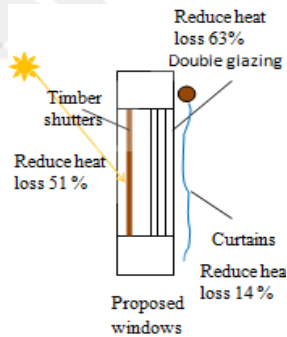
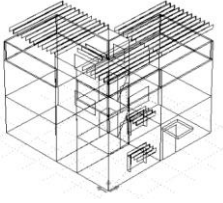
**Figure 2.3:** Libyan housing issues [45].

**2.1.3.3. Plans to solve the environmental issue in housing ;**The research of Gabriel in 2014 aimed to achieve the goal of low-energy housing with cooling and heating systems, which she confirmed by stating that *“The reduction of the energy demand for heating and cooling is the key factor in the low energy houses.”* [29]. The method of collecting data was based on a field survey and a computer energy simulation. Traditional and vernacular Libyan houses were the main sources for this study. In this study, the author selected three houses located in three climatic regions

in Libya. The aim of this survey was to examine the thermal comfort of each house in two ways: first, according to the thermal insulation of traditional Libyan clothing, and second, according to the temperature of thermal comfort in each climatic region. The positive results of traditional environmental solutions were used by the author in the proposed house models. Then the author simulated, with ESP-r, the three models and examined the results. In fact, the findings of the method led to proposing future low-energy housing as well as suggesting the standards of thermal comfort in Libya.

The study found that, by examining three traditional houses, first *“the family Structure, position of women and social intercourse effect on the space use”*(p. 259). Then the author suggested taking these factors into account in future designs of low-energy housing. Second; traditional buildings respected the local environment more than contemporary housing. Moreover, traditional solutions of thermal comfort improved the thermal performance of the model: *“the computer energy simulation results prove that targeted vernacular construction techniques improve the thermal performance of the houses in the three regions.”* Furthermore, the author emphasized that traditional environmental solutions can inform the future of low-energy Libyan housing. Finally, the use of modern materials in housing leads to high-energy consumption and poor thermal performance [48]. In addition, on-insulating materials had a major impact on the thermal performance. For future research, the study suggested that there are many lessons that could be learned from traditional buildings, including passive solar systems for lighting and a hot water supply for heating. As a result of all the above, this study presented the advantages of thermal comfort in traditional houses in three cities with different climates, and it called for the use of the strategy in future Libyan housing by improving these strategies as well as using a questionnaire to investigate the thermal comfort of traditional clothing inside a building. Finally, the most advanced way is to use simulation results with ESP-r on the models.

**Table 2.5:** Proposed sustainable solutions of previous studies in Libya, [29]. Proposed Low-Energy Houses in Libya in the hot humid zone (Tripoli)

Solution	Kind of solution design	Aim	Analysis	Proposed form
Ventilation and cooling	<ul style="list-style-type: none"> <li>-Using an airflow network in the summer</li> <li>-shading the south facades</li> </ul>	Ventilation as a source of cooling in the summer	 <p>Air flow diagram in proposed housing</p> <p>The open windows and doors allow air to pass through the indoor spaces</p>	 <p>GROUND FLOOR</p>
Heating	<ul style="list-style-type: none"> <li>-The use of double glazing</li> <li>- Good insulation (using local materials)</li> </ul>	<ul style="list-style-type: none"> <li>-Reduce heat loss</li> <li>-Provide passive heating</li> </ul>	<p>-“Double glazed windows are a most effective way to reduce the heat loss through the windows (by 63%)”</p> <p>-The wall: using insulation from the date palm in walls made with limestone inside and a breeze block outside</p> <p>-The roof: the roof is 50 mm thick, the insulation of the roof consists of date palm wood[29].</p>	 <p>FIRST FLOOR</p>  <p>Reduce heat loss 63% Double glazing</p> <p>Timber shutters Reduce heat loss 51%</p> <p>Curtains Reduce heat loss 14%</p> <p>Proposed windows</p>
Lighting	Protect the building from direct sunlight	Design shades in the summer	The secondary roof of the plant provides shade on the main roof.	
Building material	Using local material of palm insulation limestone breezeblock or sand block	Key for designing low-energy housing because it has high thermal mass	The thermal mass of local materials provides a passive heating and cooling system which is important for providing thermal comfort spaces[29].	

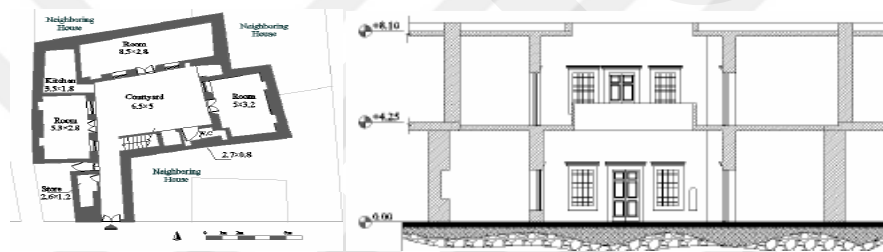
In the study of Elwefati [22], the author criticized modern concrete buildings in Libya which were not suitable in the local climate and which led to other problems such as uncomfortable indoor spaces and high energy consumption [22]. The author highlighted the advantages of traditional houses which were responsive to the local

environment. According to the author, “*the main advantage of the traditional styles was that they were friendly to their environment by way of using local building materials and by their design.*” This study compares the comfort levels of traditional and contemporary houses in the three climate regions of Tripoli, Gharyan and Ghadames to understand the bio-climatic characteristics of both types of housing as well as recording the data of temperature and humidity in the summer and winter. The methodology relied on the selection of traditional and contemporary housing with the author recording temperature and humidity data with thermo-hygrometers after which comparisons were made.

Moreover, this study used other strategies, such as interviews and questionnaires for people who had experience of living in traditional and contemporary housing. The conclusion resulting from this study were, first, that traditional housing in the coastal region in Tripoli was courtyard housing which has natural ventilation and lighting as well as provision for the privacy for women. In fact, the housing had two levels with most rooms opening out to them, as well as walls of limestone whose thickness was 50-80 cm. Second, traditional housing in the mountainous region in Gharyan had unique buildings of underground housing with wide areas in the center. As Elwefati Mentions that “*the people resorted to excavating their houses one level beneath ground level, with a low height ceiling.*” Third, the traditional housing in the desert region in Ghadames city had buildings with four floors that were built with mud bricks as well as thick walls of 45-55 cm. In addition, there were holes in the roofs which were used for ventilation and lighting.

For thermal comfort data, the results showed that thermal comfort inside the buildings in Gharyan are the better in terms of the level of thermal comfort than contemporary housing. The temperature and humidity data of the traditional houses in Ghadames City was better than contemporary housing. However, indoor thermal comfort was not at a good level. Finally, Tripoli did not record different degrees of thermal comfort in either contemporary or traditional houses. Unfortunately, the results data showed that the cooling of the modern housing depended on artificial air conditioning, especially in the summer. In such cases, these concrete buildings would consume high amounts of energy to cool their spaces. This study recommends taking advantage of traditional building design strategies and

developing them to be more suitable in the circumstances of the present, including using local materials in order to reduce energy and money consumption. Using construction materials from the local environment can reduce costs, as she mentioned here: “to provide appropriate construction materials to the local environment, and reduce the high cost of the construction operations.” According to this study, following Western architecture led to a loss in identity of the local architecture in Libya, as Elwefati, states here: “*the Western architecture in the Libyan cities, which is threatening the local architectural heritage and identity with disappearance.*” As a result, this study called for making more studies on the eastern regions of Libya, such as Benghazi (coastal regions), Abadan (mountainous regions) and Al kofra (desert regions).[22].



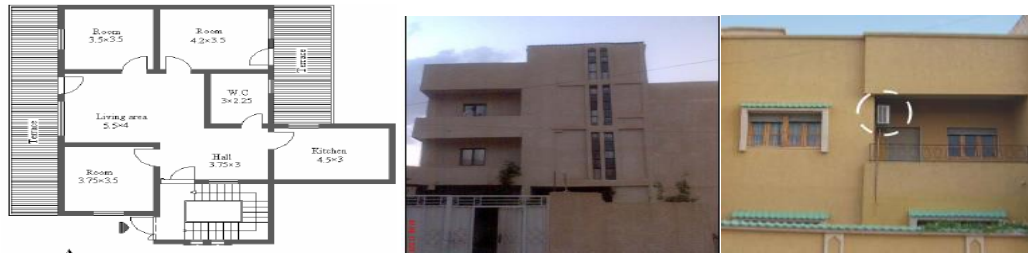
**Figure 2.4:** Traditional house in Tripoli, [22]



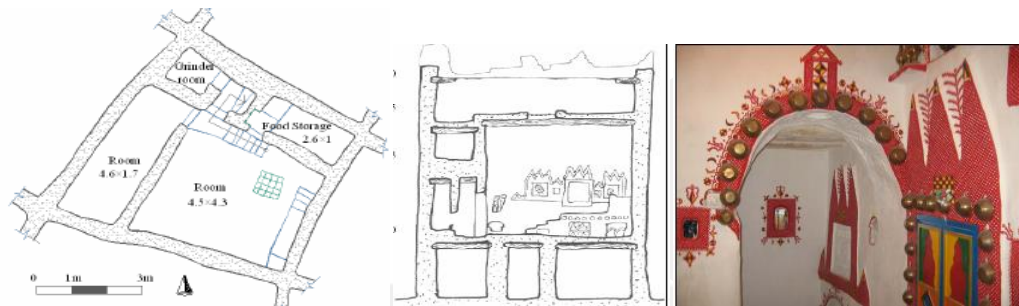
**Figure 2.5:** Contemporary house in Tripoli [22]



**Figure 2.6:** Underground house in Gharyan, [22]



**Figure 2.7:** Contemporary house in Gharyan, [22]



**Figure 2.8:** Traditional house in Ghadames [22]



**Figure 2.9:** Contemporary house in Ghadames, [22]

## 2.2 Description of the features of the courtyard and local materials in the literature

### 2.2.1. Description of traditional courtyard housing

The research of Al-Zubaidi and Shahin (2004) aimed to study sustainable traditional housing in the Arab world from an Islamic perspective. The method of the research depended on a case study which has been performed on modern and traditional houses in Baghdad in order to investigate the design solutions as well as sustainable approaches to the traditional architecture of the Arab World. Therefore, samples of buildings were under the case study in this research. The measurements of the study included efficiency of building performance which depended on the properties of building materials and the hot climate. Thus, the research discusses the many points on which the findings depended, which included (1) the role of urban planning and the site of traditional cities, (2) the role of the design approach in traditional Arab building, (3) the role of environmental design and natural ventilation, and (4) the

role of building materials as sustainable solutions in traditional housing. As a result, the findings of these points are that the urban fabric depends on detached buildings which are connected by paths, so the aim of this fabric is to provide privacy and shade for the paths.

The design approach of traditional housing relied on the courtyard as the center of the building, which provided thermal comfort, privacy, as well as an aesthetic place and natural environment. The researcher found that the courtyard is the most efficient element in a sustainable solution for Arab housing because it interacts with the environment and functions in social life. The study confirmed to design courtyards in modern housing after improving them according to the modern life of the Arab world. Furthermore, the traditional housing was able to save energy due to the natural materials which resist heat gain. These materials covered and protected buildings from the harsh climate and reflected the solar rays. The study presented important studies of Western architects, such as Mortada [39]. Ragette [41] ,who have been attracted to traditional Arab architecture ,Al-Zubaidi [4].and mention in their studies the unique characteristics of Islamic architecture as the most successful, sustainable solution at that time. The study recommended rediscovering the principles of traditional architecture and selecting the appropriate solutions for their local environments as well as using technology to achieve this goal.

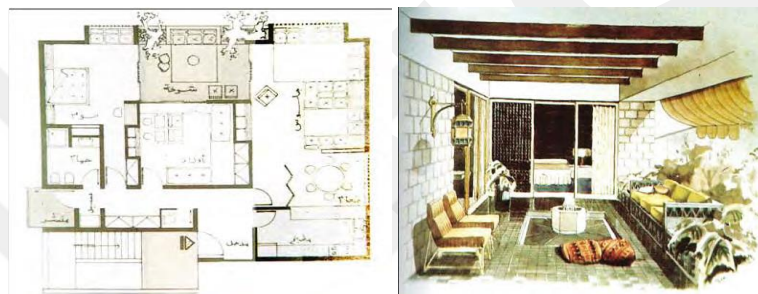
The research of Al-Zubaidi [4], mentioned that 1400 years of the Islamic religion claims to protect the environment and the natural resources as well as protect them from damage, which is the same aim of the sustainable approach nowadays. In addition, in ancient times, the behavior of Muslim people was connected with the meaning of environmental preservation in their daily life. Thus, the Islamic definition of the environment is that *“the environment is the framework of human activity and social activity as well as being the main source of wealth and production of people lives.”* On the other hand, the relationship between people and the environment from the Islamic perspective depended on the concept of preservation of the environment not being new as well as the Islamic call to reduce the consumption of resources and to reduce pollution in their cities and the preservation of God’s blessings. Furthermore, Islamic calls for the preservation of water from wasteful use, air from pollution and natural resources from loss. In such

cases, water became one of the most important elements in the design of traditional housing because of its environmental and aesthetic role. The Islamic perspective for natural plants is the protection of plants and to refrain from cutting down trees, even in the war. According to this idea, trees and plants have become a part of people's housing and they are taken advantage of to reduce the harsh climate by using them in courtyards. The principles of sustainability in the traditional architecture of the Islamic perspective are as follows: (1) To achieve the principle of privacy which aims to separate men's spaces from women's spaces; therefore, the courtyard became women's private world which was a place for women activities; (2) To achieve the principle of equality, by designing the facades of houses without distinct details or decoration. Paul Oliver, in the studies of Oliver (1997) and Al-Zubaidi [4], presented the success of traditional architecture due to the responsive to the natural resources, climatic factors and social needs.

In the book of Waziry [57], the author defined housing as "*a place where people could enjoy by comfort and quietness.*" Therefore, Waziry recommended that the design of Muslim housing must have Islamic architectural features, as he states here: "*the housing inside and outside designing must be reflect the Islamic approach.*" This part of his book deals with idea of contemporary Muslim people having to take into account Islamic approaches and principles when designing their housing. As a consequence, the study relied on presenting some important criteria that must be followed in contemporary housing for contemporary Muslims. The principles of Waziry's view include first, the principle of privacy, which includes visual privacy from the outside by the visual insulation of windows and the balcony. Colored glass, or al-mshrabea, which was used in traditional housing, could help to achieve this goal. For the design of indoor spaces, visitor spaces must be separate from family spaces, as is the case in traditional housing, by designing the rooms on the first floor. Second, in the construction of housing in the Islamic principle, the aim is not to exaggerate decorating the building as it focuses on the content of quality more than affectation in foreign decorations.

This does not mean the absence of aesthetics from the building. Thirdly, preference is given more to the wide sense of room space than to limited space. This principle is due to Muslim people needing to be connected with others and receiving guests in

their daily life. In fact, this principle has a social function. Fourthly, rooms must be oriented to Al Kabla (Mosque in Mecca), so as to connect people with their religion. Furthermore, Waziry presented in this part other religious principles which deal with Muslim behavior in daily life, such as not putting sculptures of animals in their houses, the use of silk brushes, and utensils of gold and silver. Islam also forbids the hubris of designing high buildings, which in the Islamic religion is unacceptable. Moreover, Islam separates men's spaces from women's spaces, especially in elevators in high buildings. This study reviews the views of Arab architects who rely on the principles of Islamic architecture as the main approach to their design.[57]



**Figure 2.10:** AL MSHRABEA designed and transformed the courtyard into a closed balcony. [57]

the study of Pugnali [14] presented the issue of the modern building which does not take into account climatic conditions, so this problem has led to designing a poor indoor environment that negatively impacts on the human being and the environment. *As a poor indoor climate, affects the comfort, health and efficiency*” [14] , In addition to energy consumption, the impact on the environment and increasing the cost of people living, this study in fact aimed to explain the concept of traditional Arab architecture as well as presenting its unique characteristics. Therefore, the method of this study relied on analyses of the traditional Arab town with simple of traditional buildings, as well as presenting some important solutions to protect them from nature and the climate.

As a consequence, the study achieved the goal of presenting new solutions that are suitable for a local economy, local environment and local society by improving the traditional Arab solutions. As Pugnali [14] mentioned here: *“Many traditional techniques could be improved, using new materials and knowledge, rather than totally abandoned”*In fact, this study analyzed the housing by faces on many

important elements, such as first describing the housing envelope and its materials, second, describing building design strategies that are divided into two elements: privacy and protection, and thirdly, explaining the traditional housing components including openings, walls and roofs. Fourthly, this study analyses the system of natural ventilation and its benefits. Finally, it analyses the shade and light of courtyard space.

As a result, the research found that firstly, the natural part is the major element of traditional housing, as they mention here: *“If architecture is considered as a part of nature, then the building must achieve the harmony with the ecological environment.”* [14] In fact, the study advised using this traditional architecture knowledge in modern architecture, as they said here: *“Thus it is these societies that should logically, as well as morally, benefit first from this knowledge”* [14] Furthermore, they emphasize learning from the past to build the future, especially the courtyard and Malqaf. As they state here: *“the environmental lessons to be learned from traditional architecture can be of significant value and relevance, devices such as wind towers, the use of courtyards.”* [14] As a consequence, traditional housing or buildings had huge natural principles that must be taken into account when building a contemporary design. Therefore they recommended using the traditional architecture principles to solve the environmental problems of modern housing conditions. The principles include designing a building to achieve maximum shade, providing natural ventilation, reduce to design large surfaces which are to face the sun and use reflective surfaces, and enhancing ventilation and air circulation systems.

### **2.2.2. Description of the features of using local materials**

The science paper of Nura [60] exposed the problem of housing as the most important problem facing Libya. The study explained some issues of low income and population growth, which helped to increase the housing problem in many Libyan cities. According to Nura, *“housing problems are one of the most important issues. We can find that this problem increases with the increase in population and as especially low-income class, especially in the areas of housing prices is generally low, and affordable housing is the type most needed in Libya. Problems of the central housing and the environment in the Third World Countries is still a major issue ”* [60]. In the general case, the most common issue of Third World countries is

still the high cost of houses and low income, which contributes to the emergence of other problems in the aim of providing own houses, As Nura mentions here: *“Most people in Third World Countries do not have the ability to withstand the high cost of homes.”* [60]

The aim of this study was to draw attention to raising the quality of buildings, reducing their cost and adapting to the local environment to achieve green housing as the specific goal of her paper. Therefore, a Green House would provide affordable housing for all Libyan people. Such housing would be healthier and more comfortable and have many environmental and economic benefits. A clear definition of green housing according to Nura is *“A green housing means a healthy housing in all ways, and uses less energy and resources, and its impact on maintaining environmentally.”* [60] . Moreover, she presented the most important benefits of using green housing as providing healthy indoor spaces and reducing energy consumption, as well as the side effects on the environment.

The method of this paper depended on data collection from advanced studies and research from the Western world, so those data had significant information about green buildings. The results revealed that natural materials from the local environment have many benefits, such as no side effects on the environment, reductions in the cost of construction, leading to low costs and greater availability to the community. Thus, using natural materials would help to achieve the goal of green housing, which would be adapted to the local climate and environment and reduce energy consumption. Then, it recommended that it should first encourage the community to use local materials, which should be available at high quality. Second, the modifications to them must be simple and not have a high price. Finally, the aesthetic side of natural materials should be achieved.

The study of Al-Mansuia [6] discussed the problem of the new construction of Libyan housing in Tripoli City from the perspective of energy consumption as follows: *“it applied without complete understanding of their side effects.”* [6] . Therefore, it presented the issue of a new form and construction, which has many ecological problems, such as indoor spaces relying on mechanical air conditioning to provide thermal comfort. Moreover designing houses without consideration of the local environment has a huge side effect, as she states here: *“design without*

*consideration of the local climatic conditions, which can also contribute to loss of identity related specifically to every climatic region” [6]. Therefore, this study aims to provide sustainable solutions to reduce the energy consumption of buildings and to present some principles of sustainability of a dwelling unit in Tripoli as follows: “highlight some architectural solutions that contribute to reducing (a/the) building’s energy consumption as well as creating an architecture related to the local environment and place.” [6]. For the methodology of this study, data collection depended on an analysis of private dwellings in Tripoli City as a case study as well as a review of advanced studies and the general principles of sustainability.*

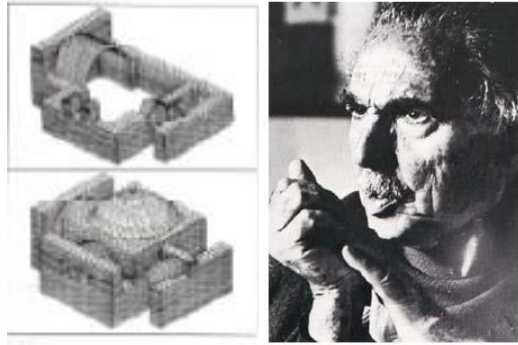
The finding of this study, firstly, focused on some principles of sustainable housing. Secondly, some design solutions were shown in an example of a private dwelling but without any detail; only the concept design was shown, as she explains here: “*The suggested design did not give a detailed form and elevations, it is a concept design showing the possibilities of designing a dwelling unit taking in consideration most of sustainable housing principles.*” [6]. She also gave the most important point, with which we agree, that flexible guidelines must be in accordance with site location, users’ needs and the creativity of the architect. This study recommended that, in the early stage of design, the process must consider the strategies of energy efficiency by using building energy simulations. As Al-Mansuria emphasizes here: “*Building energy simulations are becoming more common in the design of buildings, architects should use it in the early design stage*” [6].

### **2.2.3. How to use local materials in contemporary life by Hassan Fathy and Rasem Badran**

The study of Al Sayyed [2] pointed out how traditional cities had been isolated from modern life as follows: “*a large part of the traditional architecture is lost and no real character can be identified nor does the built environment express the long cultural history of society.*” [2], According to that, this paper aims to show us how Arab architects deal with this problem of housing in the view of form and function. In fact, the paper focused on how architects such as Rasem Badran and Hassan Fathy thought about contemporary architecture. In addition, the method of this research relies on analyzing the data of previous studies in order to understand architects’ approach to contemporary architecture. For example, Badran’s approach

is that he has transformed elements of traditional architecture into contemporary forms in most of his projects. In fact, he is a contemporary architect with roots from the past. To summarize the theoretical review of Badran's approaches, he first argued how Arab architects focused on the aesthetic of traditional elements and local materials rather than going into social and cultural factors. Second, his works did not have any European style, as he said "*The outcome stands in confrontation with foreign imported theories and ways of life that brought the Arab into isolation within his own surroundings.*" [2] Then, he explained his reason for not having designed in the Western style. Third, he did not spread the environment from socio-cultural, economic, and political factors. Fourth, his design strategy was "*re-interpreting certain elements of traditional architecture in a contemporary, concepts derived from the local environment transform elements of traditional architecture into contemporary forms.*" [2].

As a result, Barb's concept of contemporary design was "how contemporary design practice can make use of the cultural heritage of a society and still meet the requirements of contemporary life" So far, every root of Badran's concept came from the past and not from the advanced world. Al Sayyed presented the approach of Hassan Fathy (1900-1989) as he was the most famous architect who used traditional theory in his works (160 projects). He was an Egyptian architect and his most famous theoretical work is 'Architecture for the Poor' published earlier by the University of Chicago under the title '*Qurna: A tale to two villages*' in 1965. Hassan Fathy's approach to designing contemporary architecture was to use traditional solutions from the past which relied on the local environment, traditional elements of old Egyptian cities which used natural materials and reflected the social culture in his projects. Moreover, his approaches depended on history as a viable source. Finally, he called to using old techniques of building by utilizing natural resources, thereby always using the past as it is with an intention of building the present. Unfortunately, his Qurna project failed because people did not like to live in and the government did not support him.



**Figure 2.11:** Hassan Fathy, the most famous Arab architect who used traditional theory in traditional design, [2]



**Figure 2.12:** Rasem Badr, a contemporary architect who used traditional theory in contemporary design, [2]

## **CHAPTER III**

### **RESEARCH METHODOLOGY**

The research methodology is divided into two types as presented in Figure 3.1 : the methodology of the questionnaire and the methodology of case study housing. First of all, a questionnaire was given to a sample of people residing in the coastal region of Libya. the answers were used to determine environments as well as any social and economic problems. Second, case study housing in the coastal region in Derna was chosen as our example of traditional courtyard housing and contemporary housing. This housing was examined according to the people with experience of living in both traditional and contemporary housing. This chapter presents the data collected from these methods effectively as presented in the figure below.

The principal method used in this study will be questions that are related to housing and users. The result of this questionnaire will play a central role in this study by making use of users' answers to discover housing problems and to identify the real social needs related to their future housing as well as to solve the problems by way of suitable solutions. The results of the questionnaire will analyses each type of housing, specifically Traditional Housing (TH) and contemporary housing such as Apartments (AP) and Detached house (DH) as presented in Figure 3.2. Additionally, the importance of this approach will help to improve housing, making it more appropriate with regard to environmental, economic and social needs.

figure 3.1 presented research methodology and kind of data collocation , this methodology depended on two kind of study questionnaire and case study as seen below :

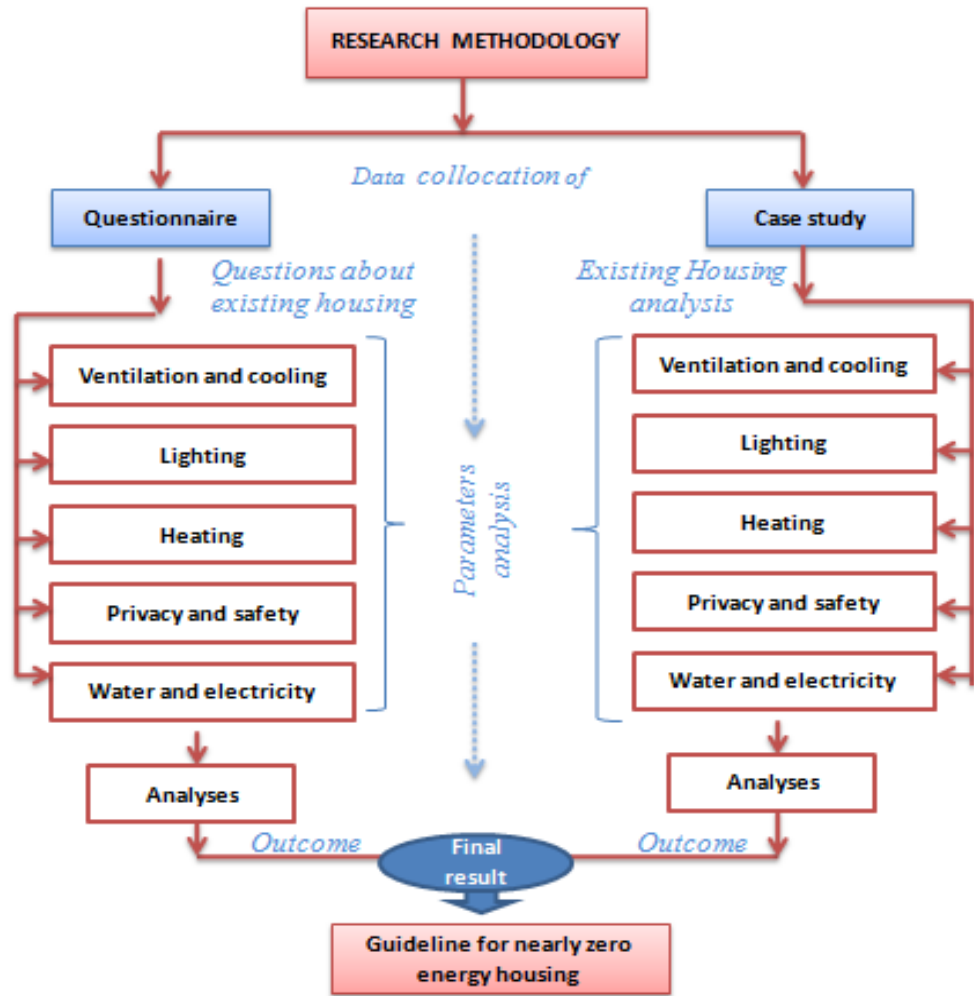


Figure 3.1: Research methodology

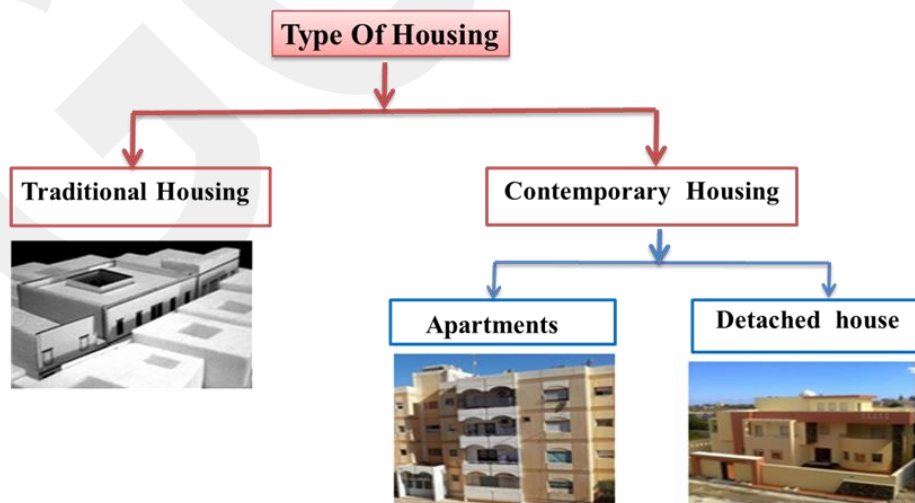


Figure 3.2: Types of housing

### 3.1. Questionnaire

In order to achieve the goal of this study, several important questions have been established. Consequently, the type of housing analyzed will be housing located on the coastal area of Libya, given that 90% of the population live in the coastal region. The housing is divided into two types: traditional housing and contemporary housing, which is also divided into two types, specifically villas and apartments. The questions in the study have two purposes: first, to identify the problems that people encounter in various types of housing, and second, to identify the treatments that will be used in any propose housing in the future. These strategies are also particular to the elements which were developed at the beginning of this study, such as environmental, social and economic elements, as presented in Figure 3.3. In fact, the principal factors that will affect this study are the environmental factors as they have a direct relationship with the research goal of nearly-zero energy.

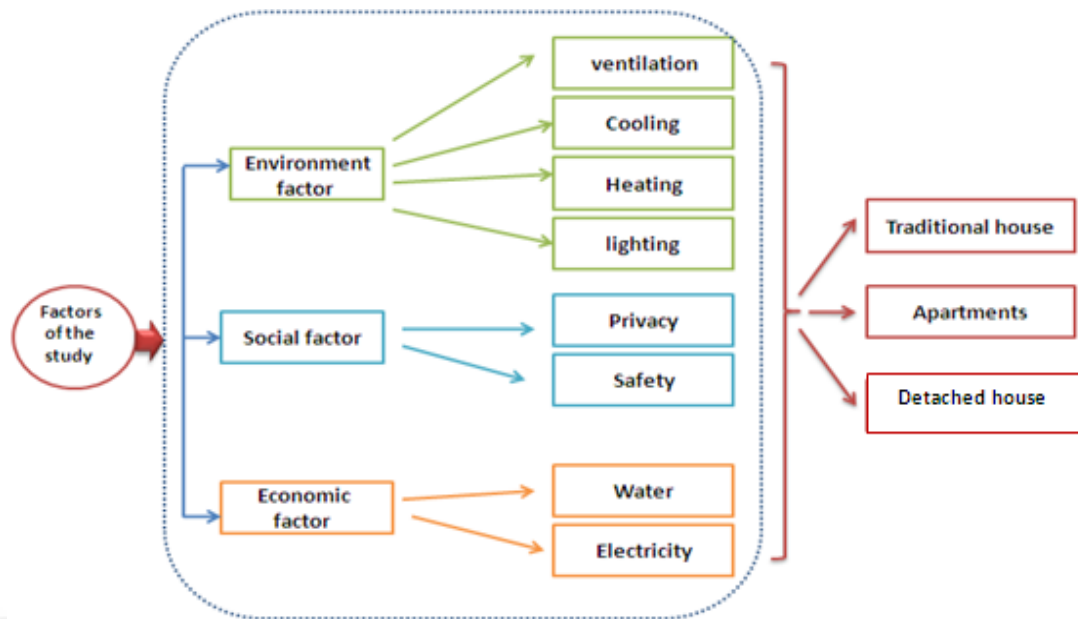
Other factors help to integrate the real concept of sustainability, which is determined by realizing people's social and economic requirements.

In the beginning, the questions were designed by the researcher to gain a greater understanding of users' experiences of housing. These questions were based on housing environments, in addition to social and economic factors. First of all , a pilot study was conducted to ensure that all the issues are understandable and will lead to the aim of this step of the research.

The diagram of Figure 3.3 presented the main factors of sustainable approach , environment

social and economic factors, in this research some factors of sustainable will add according to Libya situation as the following part ;

- a. **Environment factor** ; ventilation , cooling , heating and lighting
- b. **Social factor** ; privacy and safety
- c. **Economic factor** ; water needs

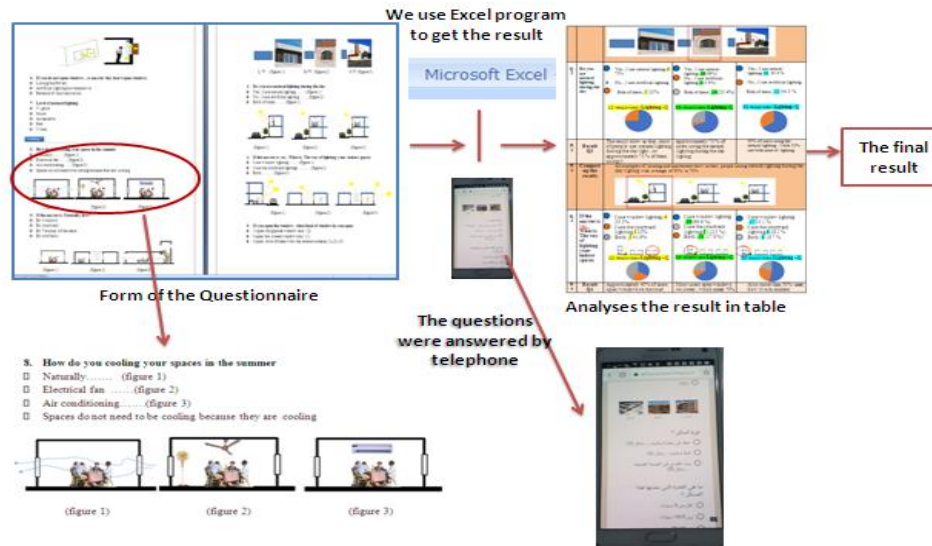


**Figure 3.3:** Types of factors

Later, an improved questionnaire was applied to a number of people, most of whom were living in Libya. In this case, MS Excel was used online by Face book and Viber groups. Table 3.1 shows the sample of people who answered the questions.

**Table 3.1:** Information related to houses and owners

Questions	Traditional housing 26 responses	Apartment 56 responses	Detached house 32 responses
<b>Gender</b>	<input type="checkbox"/> Male: 15 <input type="checkbox"/> Female: 11	<input type="checkbox"/> Male: 24 <input type="checkbox"/> Female: 32	<input type="checkbox"/> Male: 19 <input type="checkbox"/> Female: 13
<b>Ownership</b>	<input type="checkbox"/> Owner; 13 <input type="checkbox"/> Renter ;1 <input type="checkbox"/> Live with my original family: 12	<input type="checkbox"/> Owner:36 <input type="checkbox"/> Renter:9 <input type="checkbox"/> Live with my original family: 11	<input type="checkbox"/> Owner:21 <input type="checkbox"/> Renter: 0 <input type="checkbox"/> Live with my original family: 11
<b>Where do you live now?</b>	<input type="checkbox"/> Live in Libya : 5 <input type="checkbox"/> Live in Turkey: 7 <input type="checkbox"/> Note: For 14 responses	<input type="checkbox"/> Live in Libya: 30 <input type="checkbox"/> Live in Turkey: 26	<input type="checkbox"/> Live in Libya: 12 <input type="checkbox"/> Live in Turkey: 19
<b>How long have you been living in thishouse/a partment?</b>	<input type="checkbox"/> Less than five years: 2 <input type="checkbox"/> Between 5 and 10:5 <input type="checkbox"/> Between 10 and 20: 2 <input type="checkbox"/> Between 20 and 30: 1 <input type="checkbox"/> More than 30: 1 Note: For 14 responses	<input type="checkbox"/> Less than five years: 24 <input type="checkbox"/> Between 5 and 10: 10 <input type="checkbox"/> Between 10 and 20: 8 <input type="checkbox"/> Between 20 and 30: 10 <input type="checkbox"/> More than 30: 4	<input type="checkbox"/> Less than five years: 4 <input type="checkbox"/> Between 5 and 10: 11 <input type="checkbox"/> Between 10 and 20: 10 <input type="checkbox"/> Between 20 and 30: 4 <input type="checkbox"/> More than 0: 3



**Figure 3.4:** Results of the questionnaire

This diagram presented the stages of data collection as the following : the questionnaire have been given to sample of people who are living in hot humid climate , then it was answered by EXCEL program in the aim to get the quick and accurate results , finally the data was analyzed in table as presented in appendix ( B) which have 50 questions , each question has been analyzed with graphics.

### 3.1.1. Discussion and analysis

The houses have been scrutinized and analyzed with respect to three factors, specifically environmental, social and economic factors, which are explained as follows:

**3.1.1.1. Enviromental factors ;**This section of the study examines users' opinions about the main environmental systems such as cooling, ventilation, heating and natural lighting, as illustrated in the following:

a. **Cooling system ( in summer time ):** The results for the cooling system show that 90% of users in TH use air conditioning to cool their spaces; 60% of users in AP use air conditioning to cool their spaces, while 80% of users in DH use air conditioning to cool their spaces (Figure 3.5).

**Note;** users used the air conditions in traditional housing when the desert winds came and in high humidity days .



**Figure 3.5:** Cooling System

The table of 3.2 presented comparison between three kind of housing according to users answers and it illustrated the cooling system which was used in different kind of housing, therefore this table used for building part of the result of this study ( for more information go to appendix C).

**Table 3.2:** Cooling system

Q	Questions	The Result of traditional housing Number of responses; 26	The Result of apartments Number of responses;56	The Result of Detached house Number of responses; 32
Q.8	How do you cooling your spaces in the summer?	<ul style="list-style-type: none"> <li><span style="color: blue;">●</span> Naturally; 4 <u>15%</u></li> <li><span style="color: red;">●</span> Electrical fan <u>14%</u></li> <li><span style="color: green;">●</span> Air conditioning; <u>2077%</u></li> <li><span style="color: purple;">●</span> Spaces do not need to be cooling because they are cooling : <u>14%</u></li> </ul> <p>26 responses- cooling-Q</p>	<ul style="list-style-type: none"> <li><span style="color: blue;">●</span> Naturally; 14 (25 %)</li> <li><span style="color: orange;">●</span> Electrical fan ;1 (1.7 %)</li> <li><span style="color: grey;">●</span> Air conditioning ;36 (64.2 %)</li> <li><span style="color: yellow;">●</span> Spaces do not need to be cooling because they are cooling;5 (8.9%)</li> </ul> <p>56 responses- cooling-Q</p>	<ul style="list-style-type: none"> <li><span style="color: blue;">●</span> Naturally ; 4 12.5 %</li> <li><span style="color: orange;">●</span> Electrical fan ;1 3.1 %</li> <li><span style="color: grey;">●</span> Air conditioning ; 26 81.2 %</li> <li><span style="color: yellow;">●</span> Spaces do not need to be cooling because they are cooling ;1 3.1 %</li> </ul> <p>32 responses- cooling-Q</p>
R8	Result t Q8	77% of users used Air conditioning in TH.	Approximately 60% of users in AP using Air conditioning.	80% of users in DH also using Air conditioning.
R8	Comparing the	<p>All users use Air condition instead of natural cooling</p>		
Q.9	If the answer is Naturally, how?	<ul style="list-style-type: none"> <li><span style="color: blue;">●</span> By windows ;<u>964%</u></li> <li><span style="color: red;">●</span> By courtyard ;<u>429%</u></li> <li><span style="color: green;">●</span> By Vacuum of the stairs <u>17%</u></li> <li>No answer =7</li> </ul> <p>14 responses -cooling-Q</p>	<ul style="list-style-type: none"> <li><span style="color: blue;">●</span> By windows; 34 (89.4 %)</li> <li><span style="color: orange;">●</span> By courtyard; 3 (7.8%)</li> <li><span style="color: grey;">●</span> By Vacuum of the stairs; 1 (2.6%)</li> </ul> <p>38 responses -cooling-</p>	<ul style="list-style-type: none"> <li><span style="color: blue;">●</span> By windows ;952.9 %</li> <li><span style="color: orange;">●</span> By courtyard ;4 23.5 %</li> <li><span style="color: grey;">●</span> By Vacuum of the stairs; 2 11.7 %</li> </ul> <p>17 responses -cooling-</p>
R9	Result Q9	64% of people in TH cooling their spaces by windows	90% of users prefer to open windows on street more than others ways	Also users in DH by average of 50% open windows on street
R9	Comparing the	<p>All users cooling their spaces by opening window on street more than other ways</p>		

b. **Natural ventilation system:** All users in TH apply natural ventilation and 90% ventilate their spaces using windows. Roughly 80% of users use natural ventilation in their spaces, while 20% use artificial ventilation. Approximately 90% of residents open windows to ventilate places. However, in DH, 95% of users employ natural ventilation in their spaces. Moreover, 90% of people who live in these houses use natural ventilation via their windows (Figure 3.6).

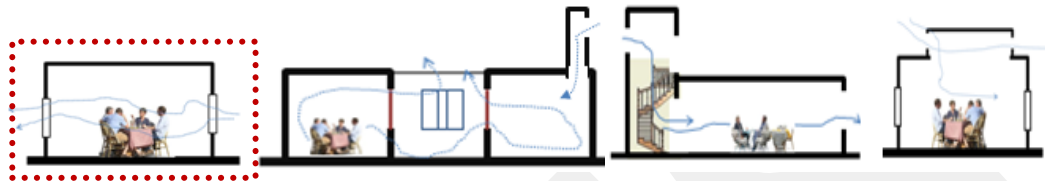


Figure 3.6: Ventilation System

Approximately 90% of users in a different kind of housing using the windows to ventilation their spaces.

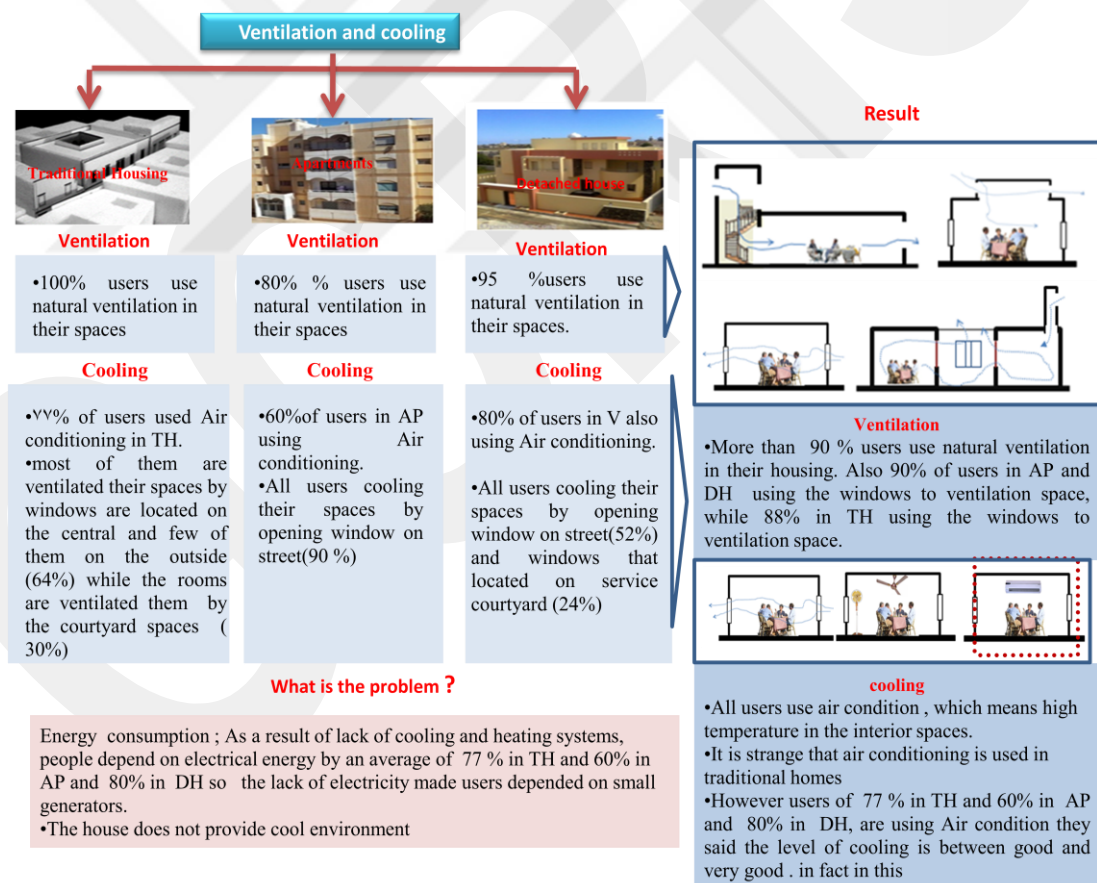


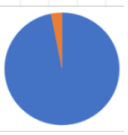
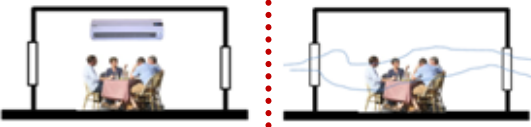
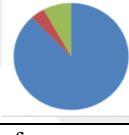
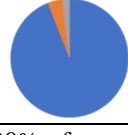
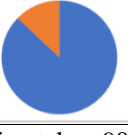



Figure 3.7: Ventilation and cooling results

The table 3.3 below presented data analyses of ventaltion system which was used in different kinds of houses . ( for more information go to appendix C ).

Table 3.3 ;Ventaltion system

Q	Questions	The Result of traditional housing Number of responses; 26	The Result of apartments Number of responses;56	The Result of Detached house Number of responses; 32
Q.13	What kind of ventilation do you use	<ul style="list-style-type: none"> <li><input checked="" type="radio"/> Natural ventilation :25 100%</li> <li><input type="checkbox"/> Artificial ventilation</li> </ul> No answer =1 25 responses 	<ul style="list-style-type: none"> <li><input checked="" type="radio"/> Natural ventilation: 44(78.5 %)</li> <li><input checked="" type="radio"/> Artificial ventilation; 12 (21.4%)</li> </ul> 56 responses 	<ul style="list-style-type: none"> <li><input checked="" type="radio"/> Natural ventilation :31 96.8 %</li> <li><input checked="" type="radio"/> Artificial ventilation ;1 3.1 %</li> </ul> 32 responses 
R13	Result Q13	100% users use natural ventilation in their spaces.	80% % users use natural ventilation in their spaces. while 20% use Artificial ventilation.	95 % % users use natural ventilation in their spaces.
R13	Comparing the	more than 80% users use natural ventilation in their housing. 		
Q.14	How do your ventilation your spaces?	<ul style="list-style-type: none"> <li><input checked="" type="radio"/> By windows ;2188%</li> <li><input checked="" type="radio"/> By courtyard ;14%</li> <li><input type="checkbox"/> By Vacuum of the stairs</li> <li><input checked="" type="radio"/> By roof halls :28%</li> <li><input type="checkbox"/> Others</li> </ul> No answer =2 24 responses -Ventilation-Q 	<ul style="list-style-type: none"> <li><input checked="" type="radio"/> By windows ;46 (93.8)</li> <li><input checked="" type="radio"/> By courtyard ;2 (4%)</li> <li><input checked="" type="radio"/> By Vacuum of the stairs (2 %)</li> <li><input type="checkbox"/> By roof halls</li> </ul> 49 responses-- Ventilation-Q 	<ul style="list-style-type: none"> <li><input checked="" type="radio"/> By windows; 2787%</li> <li><input checked="" type="radio"/> By courtyard 12.9 %</li> <li><input type="checkbox"/> By Vacuum of the stairs</li> <li><input type="checkbox"/> By roof halls</li> </ul> 31 responses -Ventilation-Q 
R14	Result Q14	88% of users using the windows to ventilation space	Also 90% of users in AP using the windows to ventilation space	Approximately 90% of people who live in this kind of housing use natural ventilation by windows.
R14	Comparing the results	Approximately 90% of users in a different kind of housing using the windows to ventilation their spaces. 		

c. **Heating system:** All users are dependent on electrical energy to heat their spaces. However, users in AP depend on electrical energy to heat their spaces at an average of 75%. More than 75% of the users in DH use electrical boilers,

while 25% utilize air conditioning, which means that the users depend on electrical energy to heat their spaces at an average of 100%.



Figure 3.8: Heating system

users cooling their spaces by opening window on street more than other ways

The diagram below illustrates the data analysis of heating system and this diagram is helpful when need information about how users heating their rooms in winter in different kinds of houses.

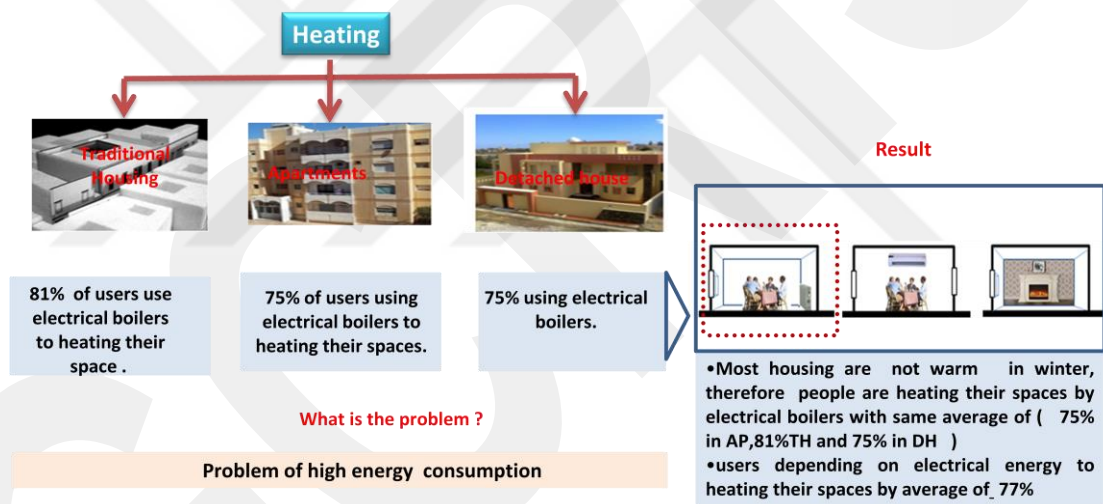
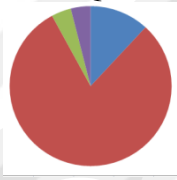
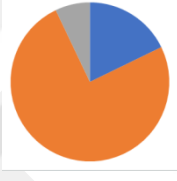




Figure 3.9: Heating system

This table illustrated information about how users heating their spaces in winter in different kinds of houses . ( for more information go to appendix ( B ) )

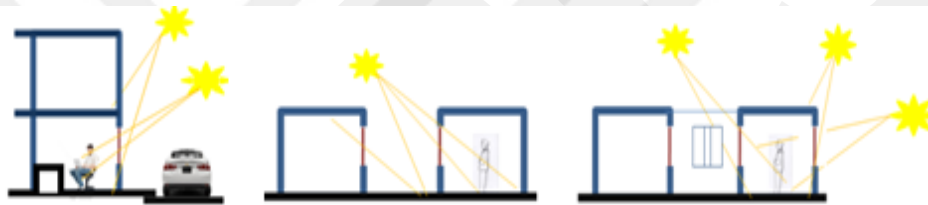
**Table 3.4 : Heating system**

Q	Questions	The Result of traditional housing Number of responses; 26	The Result of apartments Number of responses;56	The Result of Detached house Number of responses; 32
Q11	How do you heating your spaces in the winter?	<ul style="list-style-type: none"> <li><span style="color: blue;">●</span> Air conditioning; 3 <u>12%</u></li> <li><span style="color: red;">●</span> Electrical boilers;21 <u>81%</u></li> <li><span style="color: green;">●</span> Stove :<u>14%</u></li> <li><span style="color: grey;">□</span> The spaces are warm</li> <li><span style="color: purple;">●</span> Other way :<u>14%</u></li> </ul> <p>26 responses- Heating-Q</p> 	<ul style="list-style-type: none"> <li><span style="color: blue;">●</span> Air condition;10 (17.8%)</li> <li><span style="color: orange;">●</span> Electrical boilers; 42 (75%)</li> <li><span style="color: grey;">●</span> Stove; The spaces are warm; 4 (7.1%)</li> </ul> <p>56 responses- Heating-Q</p> 	<ul style="list-style-type: none"> <li><span style="color: blue;">●</span> Air condition; 5 16.1%</li> <li><span style="color: orange;">●</span> Electrical boilers; 24 77.4 %</li> <li><span style="color: grey;">●</span> Stove; The spaces are warm; 2 6.4%</li> </ul> <p>31 responses- Heating-Q</p> 
R11	Result Q11	12% of users using Air conditioning to heating their space . while <u>81%</u> use Electrical boilers.	<u>75%</u> of users using Electrical boilers to heating their spaces.	More than <u>75%</u> using Electrical boilers, while 25% using air condition
R11	Comparing the results	<p>All users how to live in two kinds of housing and apartment using electrical boilers in the same average of <u>75%</u>, while other using air condition with average between <u>12%</u> and 18%.</p> <p>Note; users depending on electrical energy to heating their spaces by average of <u>100%</u></p> 		

d. **Lighting system:** Approximately 70% of users in TH employ natural lighting during the day. They light their spaces by means of the windows which face on to the streets. 65% of users use natural lighting, while 30% use both types of lighting. Additionally, more than 50% of users who live in modern housing employ windows that open on to the streets, in contrast with windows which open out to courtyards.



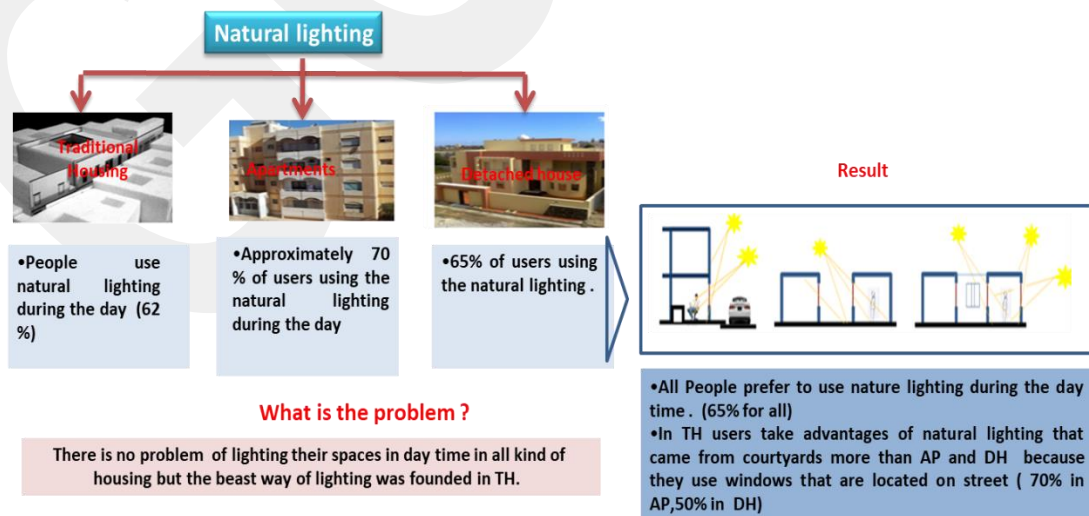
**Figure 3.10: Window sizes of housing;** all users have mid-size windows (up of 70%).



**Figure 3.11: Natural lighting**

On two kinds of AP and MH users prefer to use windows that are open on the street





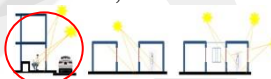

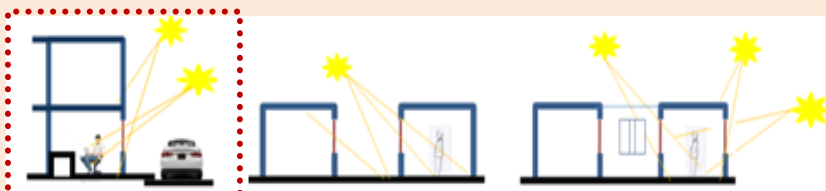
The figure 3.12 presented the result which come from users answer and it presented how people lighting their rooms during the day .



**Figure 3.12: Natural lighting results**

The table 3.5 , presented lighting system which are used in different typs of houses according to usres answer . ( for more information go to appendix ( B ) )

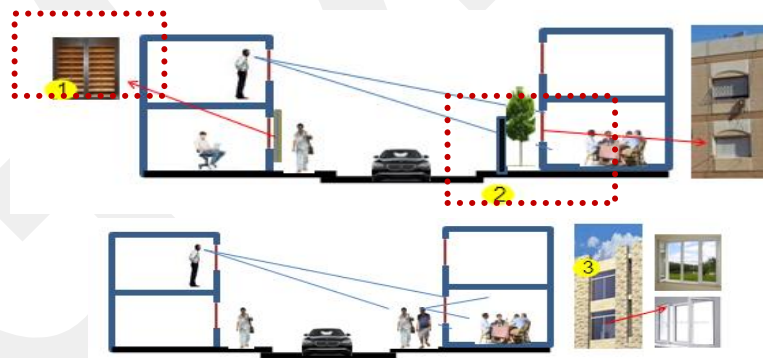
**Table 3.5 ;Lighting system**

Q	Questions	The Result of traditional housing Number of responses; 26	The Result of apartments Number of responses;56	The Result of Detached house Number of responses; 32
Q4	If the answer is <u>yes</u> , whatis the way of lighting your indoor spaces	<ul style="list-style-type: none"> <li><span style="color: blue;">●</span> I use window lighting ;9 38%</li> <li><span style="color: red;">●</span> I use the courtyard lighting 17%</li> <li><span style="color: green;">●</span> Both ;11 46%</li> <li>No answer =2</li> </ul>  <p>24 responses-Lighting-Q</p> 	<ul style="list-style-type: none"> <li><span style="color: blue;">●</span> I use window lighting;39(69.6 %)</li> <li><span style="color: grey;">●</span> I use the courtyard lighting (12.5 %)</li> <li><span style="color: orange;">●</span> Both ;10 (17.8 %)</li> </ul>  <p>56 responses-Lighting-Q</p> 	<ul style="list-style-type: none"> <li><span style="color: blue;">●</span> I use window lighting;1753.1 %</li> <li><span style="color: orange;">●</span> I use the courtyard lighting's 28.1 %</li> <li><span style="color: grey;">●</span> Both;6 18.7 %</li> </ul>  <p>32 responses-Lighting-Q</p> 
R4	Result Q4	Approximately 46% of users open windows on the court yard and street	Most users' open windows on thestreet, which mean 70% Of them using these windows.	Also, more than 50% users how to live in the modern housing using the windows that are open on the street more than window open in the courtyard.
R4	Comparing the results	<p>On two kinds of AP and DH users prefer to use windows that are open on the street.</p> 		

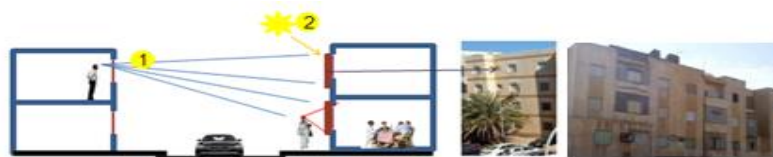
### 3.1.1.2. Social factors

The main social factors studied here were privacy and safety in order to discover why users close their windows during the day, and surrounding the villa with a high wall why they close most of their balconies, as illustrated in the following section.

- a. **Privacy system:** More than 80% of people in the TH prefer a partition between women and men in their spaces. As a result, 60% of users stated that the level of privacy is very good, while 40% said it is good. The design of the house achieved privacy with respect to the central courtyard in windows that open inwards and regarding the indirect entrance. 70% of apartments are surrounded by walls, while 30% do not have walls. Indeed, most windows surrounded by walls obscure viewing. The reason is that an average of 50% of users do not like to be seen by neighbors, whereas 40% prefer to close out the windows (Figure 3.9, as shown inform 1). Furthermore, virtually% of new housing (DH) have fences, while 15% do not have fences. 35% of users have glass windows (3) and fences which obscure the vision, whereas 25 % of houses have walls that obscure inhabitants' views. Moreover, 24 out of 65 users (35% of all users) close the windows during the day. Their reason for that was that practically one-third of users do not like to be seen by neighbors, while 60% of users prefer to close the windows for no obvious reason.



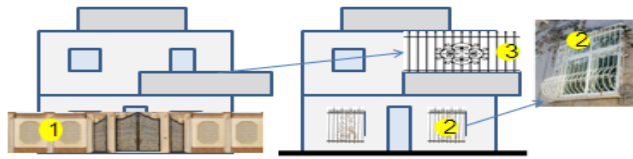
**Figure 3.13: Privacy system analysis 1;** 58% of users in TH have windows that obscure the view, while 35% of users in AP have windows that obscure the view. However, 60% of DH have walls which obscure the view.



**Figure 3.14: Privacy system analysis 2;** 45% of users do not like to be seen by neighbours, while% of users prefer to close the windows without a reason.

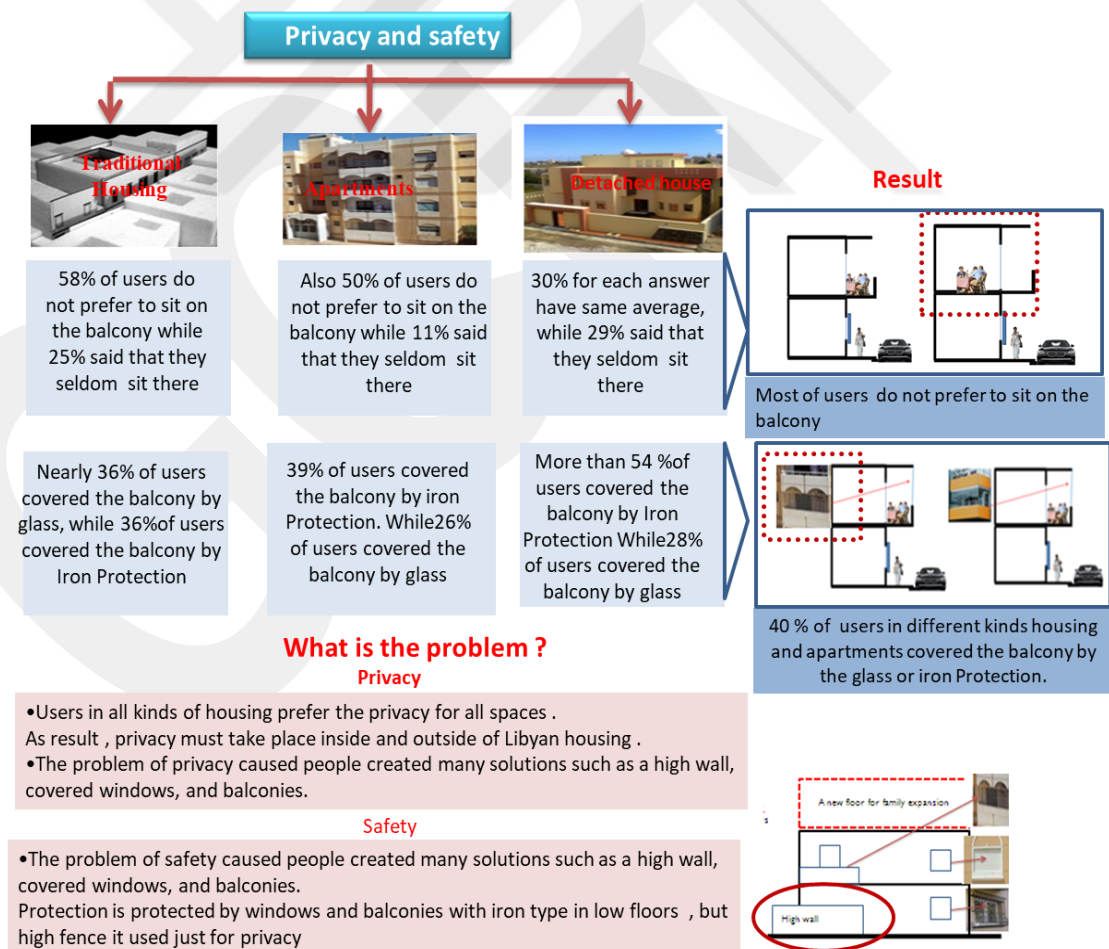
b. **Safety system:** 85% of users in TH are satisfied with the degree of safety although they made several modifications. However, the results show that 50% of users in AP prefer to live near their relatives. 30% of users made their homes more secure by enclosing their balcony, while 35% prefer to close off their balcony, close their windows (the out wooden windows) and build high walls. Additionally, 70% of users in MH employ a high fence, a closed balcony and closed windows.

*Between 33% to 68% using all solutions that achieve the safety goal in their housing or apartments*



**Figure 3.15:** Privacy and safety issues

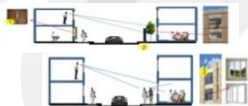

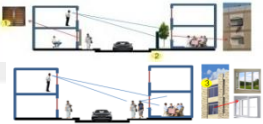

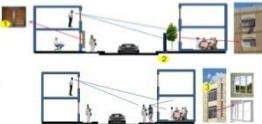

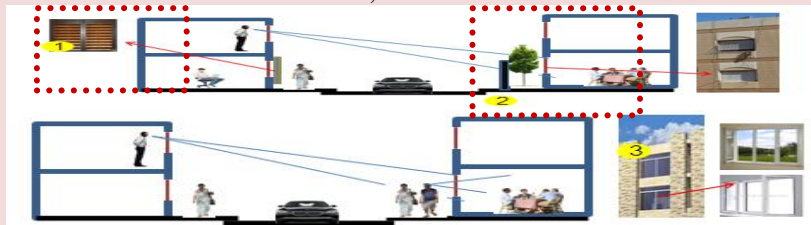
Figure 3.16 show the privacy and safety result for using outdoor spaces as well as identify the problem of lack of the privacy in contemporary houses .



**Figure 3.16:** Privacy and safety needs

The table 3.6 show degree of privacy in users houses , and what they did to achieve this goal with balconies, windows and garden of house .

**Table 3.6 ;privacy system**

Q	Questions	The Result of traditional housing Number of responses; 26	The Result of apartments Number of responses;56	The Result of Detached house Number of responses; 32
Q.18	Which of these designs exist in your home .....	<ul style="list-style-type: none"> <li><span style="color: blue;">●</span> Windows that obscure the vision (1);14 58%</li> <li><span style="color: red;">●</span> Wall that obscures the vision (2);1 4%</li> <li><span style="color: green;">●</span> Both....(1) ,(2);4 17%</li> <li><span style="color: purple;">●</span> Large windows and glass which not obscure vision....(3);2 8%</li> <li><span style="color: blue;">●</span> Glass windows (3) and fence which obscures the vision (2);3 13%</li> <li>No answer =2</li> </ul>  <p>24 responses-Privacy -Q</p> 	<ul style="list-style-type: none"> <li><span style="color: blue;">●</span> Windows that obscure the vision (1)18(36.7%)</li> <li><span style="color: orange;">●</span> Wall that obscures the vision (2); 4 (8.1 %)</li> <li><span style="color: grey;">●</span> Both.... (1), (2);8 (16.3 %)</li> <li><input type="checkbox"/> Large windows and glass which not obscure vision....</li> <li><span style="color: yellow;">●</span> (3)16 (32.6 %)</li> <li><input type="checkbox"/> Glass windows (3) and fence which obscures the vision (2);3 (6.1 %)</li> </ul>  <p>49 responses-Privacy-Q</p> 	<ul style="list-style-type: none"> <li><span style="color: blue;">●</span> Windows that obscure the vision (1);5 16.6 %</li> <li><span style="color: orange;">●</span> Wall that obscures the vision (2);8 26.6 %</li> <li><span style="color: grey;">●</span> Both.... (1), (2);4 13.3 %</li> <li><span style="color: yellow;">●</span> Large windows and glass which not obscure vision....</li> <li><span style="color: blue;">●</span> (3);2 6.6 %</li> <li><span style="color: lightblue;">●</span> Glass windows (3) and fence which obscures the vision (2);11 36.6 %</li> </ul>  <p>30 responses-Privacy -Q</p> 
R18	Result Q18	58% of users have windows that obscure the vision	36% of apartments have windows that obscure the view,	16.6% of housing have windows that obscure the view, while they have Glass windows (3) and fence which obscures the vision (2);11 36.6
R18	Comparing the results	<p>58% of users in TH have windows that obscure the vision, while 35% users in AP have windows that obscure the vision. However 60% of DH have wall which obscures the vision,</p>  <p>Note: As result, users prefer to obscure indoor spaces from the vision out door spaces</p>		

### 3.1.1.3. Economic factor

The issue of the economic factories determined by water especially after the war of 1911. This part of the study discusses the issue of the economic factor.

**Water system:** 40% of people who live in TH stated that the level of water is poor. As a result, 90% buy water from the private sector. This means that people encounter another problem concerning water availability. However, 60% of users in AP pay water bills to the government, whilst, 40% do not pay. Regarding the availability of water, 70% of users stated that it is available, while 40% of users buy their water. Finally, 75% of users in DH said that water is available, whereas 25% said it is not available. Consequently, 30% of users buy water, while approximately 70% have wells.

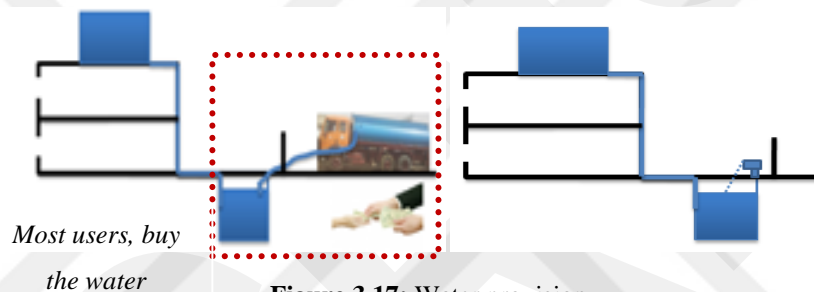


Figure 3.17: Water provision

In figure 3.18 presented the result of water shortage, because this problem is still big problem now, therefore people buy water and have tank for save it for mostly one week, but their answer did not reflect the real of their problem of water need. (the water available because they buy it)

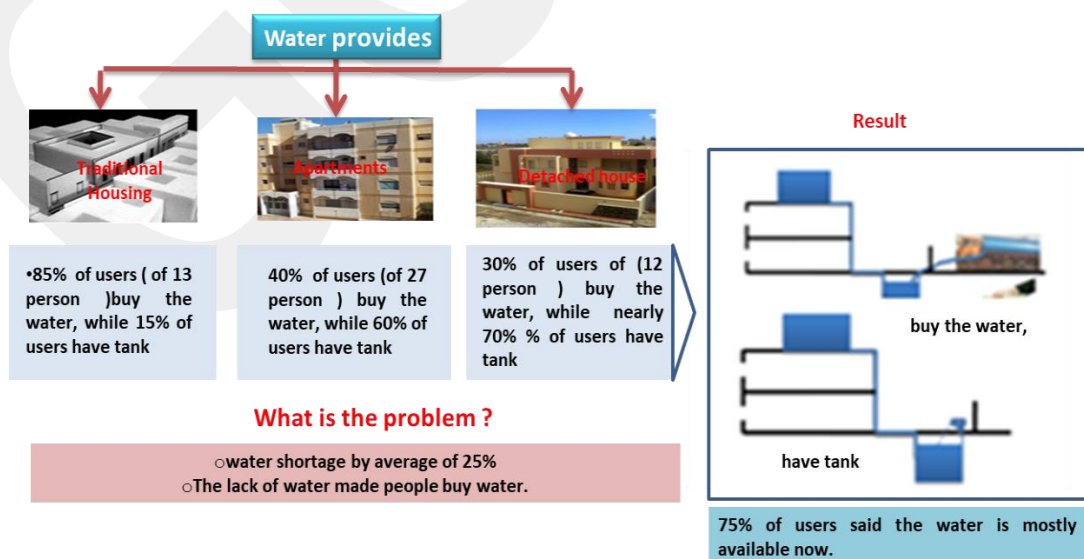


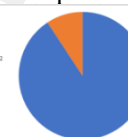
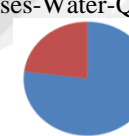

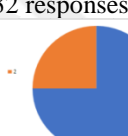
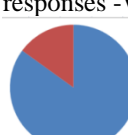
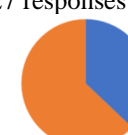
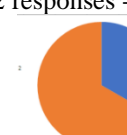
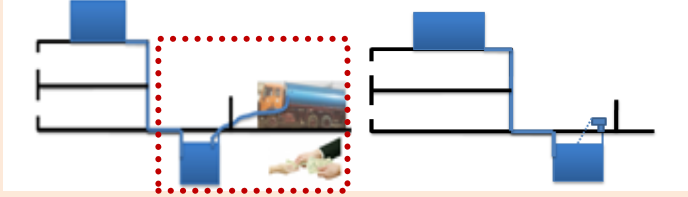


Figure 3.18: Water provision

The table 3.7 show the compration between different typs of houses for water needs . the result of users answers did not reflect the real problem of water shortage .

**Table 3.7; Water system**

Q	Questions	The Result of traditional housing Number of responses; 26	The Result of apartments Number of responses;56	The Result of detached house Number of responses; 32
Q.41	Does the water available before	<p>● Yes; 18 69%</p> <p>● No; 8 31%</p> <p>11 responses-Water-Q</p> 	<p>● Yes; 41 (73.2 %)</p> <p>● No; 15 (26.7 %)</p> <p>56 responses-Water-Q</p> 	<p>● Yes; 29 90.6 %</p> <p>● No; 3 9.3 %</p> <p>32 responses-Water-Q</p> 
R41	Result	69% of users said it is available.	70% of users said it is available.	90% of users said it is available.
R41	Comparing	The water is mostly available before 2011		
Q.42	Does the water available now?	<p>● Yes; 20 77%</p> <p>● No; 6 23%</p> <p>26 responses-Water-Q</p> 	<p>● Yes; 32 (72.7%)</p> <p>● No; 12 (27.2 %)</p> <p>44 responses-Water-Q</p> 	<p>● Yes; 24 75%</p> <p>● No; 8 25 %</p> <p>32 responses-Water-Q</p> 
R42	Result Q 42	77% % of users said that the water is available.	70% of users said it is available.	75% of users said it is available.
R42	Comparing the	The water is mostly available now.		
Q.43	If the answer is no,how do you get the	<p>● I Buy the water ;11 85%</p> <p>● I have Well ;2 15%</p> <p>□ No answer =10</p> <p>13 responses -Water-Q</p> 	<p>● I Buy the water ;10 (37%)</p> <p>□ I have Well; 17 (62.9 %)</p> <p>27 responses -water-Q</p> 	<p>● I Buy the water ;4 33.3 %</p> <p>● I have Well; 8 66.6 %</p> <p>12 responses -Water-Q</p> 
R43	Result Q 43	85% of users buy the water, while 15% of users have Well	40% of users buy the water, while 60% of users have Well	30% of users buy the water, while nearly 70% of users have Well

<b>R43</b>	<b>Comparing the results</b>	 <ul style="list-style-type: none"> <li>- 85% users of all users who live in TH said they buy the water</li> <li>- 30% ( 27 ) users of all users ( 44 ) who live in AP said they have Well with average of 60% of them</li> <li>- 25% ( 12 ) users of all users ( 32 ) who live in DH said they have Well with average 70%</li> </ul>
------------	------------------------------	---

#### 3.1.1.4. People's needs

People in different types of housing have various needs. First, people need privacy and safety solutions as essential elements. Second, they need solutions for lighting and ventilation systems. Third, they prefer housing with gardens more than courtyards. Finally, they prefer high fences in contrast to low fences.

It is obviously revealed that housing in Libya is affected by three factors; these factors were come from social, environment, economic aspects. Firstly, the social factor, which includes privacy and safety, is affected by Libyan housing design processes in many ways. Users in different types of homes use the same solutions to achieve the goal of privacy, such as high fences surrounding their houses as well as carved and closed windows (high fences 5%, closed balconies 5%, closed windows 30%, and all the above 50%). Most users prefer not to sit on their balconies. Secondly, the environmental aspects include heating, cooling, lighting and ventilation. Each type of housing was analyzed by means of questions to discover the environmental problems. For instance, regarding the heating system, 70% of users said that they heat their spaces using electrical boilers, whereas% used air conditioners, which means that they depended on electrical energy to heat their areas by an average of 90%. However, cooling system users depended on electrical power because they used air conditioners (75%) instead of natural cooling with lighting systems. Moreover, 70% of people who live in this type of housing stated there is no problem related to using natural light during the day. Finally, from the context of a ventilation system, approximately 90% of users from different types of housing agree on one point, which is that each of them uses the windows to ventilate their spaces. Economic factors include the availability of electricity and water. For example, 55% of users said that electricity is available now, while 45% said the

electricity is not available. Furthermore, 75% of users light their houses using generators. Regarding water supply, users said that water is mostly available at an average of 70%. Therefore, 30% of users did not have water, (45% of them had wells, whereas 55% purchased water ). In fact, users are now suffering from a critical situation in the case of a lack of electricity and water. Additionally, it should be noted that housing and apartments do not have natural cooling systems in the summer; therefore, users depend on air conditioners at an average of 90% in TH, 60% in AP and 80% in DH.

This study highlights the problems associated with contemporary and traditional Libyan houses in hot humid regions. In our case, environmental problems have been identified in relation to four important elements: ventilation, cooling, heating and natural daylight lighting. While social problems were also addressed in two parts, namely privacy and security problems, in addition to the economic problems of water and electricity shortages, the methodology used to identify these problems was in a questionnaire given to a sample of people living in such homes located in the hot humid zone. As a result, the questions covered all the previous points. Consequently, the results revealed the principal problems that the Libyan people face concerning the high consumption of electrical energy.

To conclude the housing issue:

- Most houses are not warm in winter; therefore, people are heating their spaces by means of electrical boilers at an average of 75% in AP, TH and PH.
- As a result, the lack of cooling and heating systems made people depend on electrical energy. The lack of electricity made users dependent on small generators (40% in TH, 97% in AP, and 80% in DH).
- The lack of water meant people were forced to purchase water.
- The problem of privacy and safety resulted in people creating numerous solutions, such as high walls, covered windows and balconies. 90% of the solutions obscure vision in TH, 65% in AP and 55% in DH).

Figure 3.19 presented users' needs for future houses of lighting, ventilation, privacy and safety as seen in this diagram .

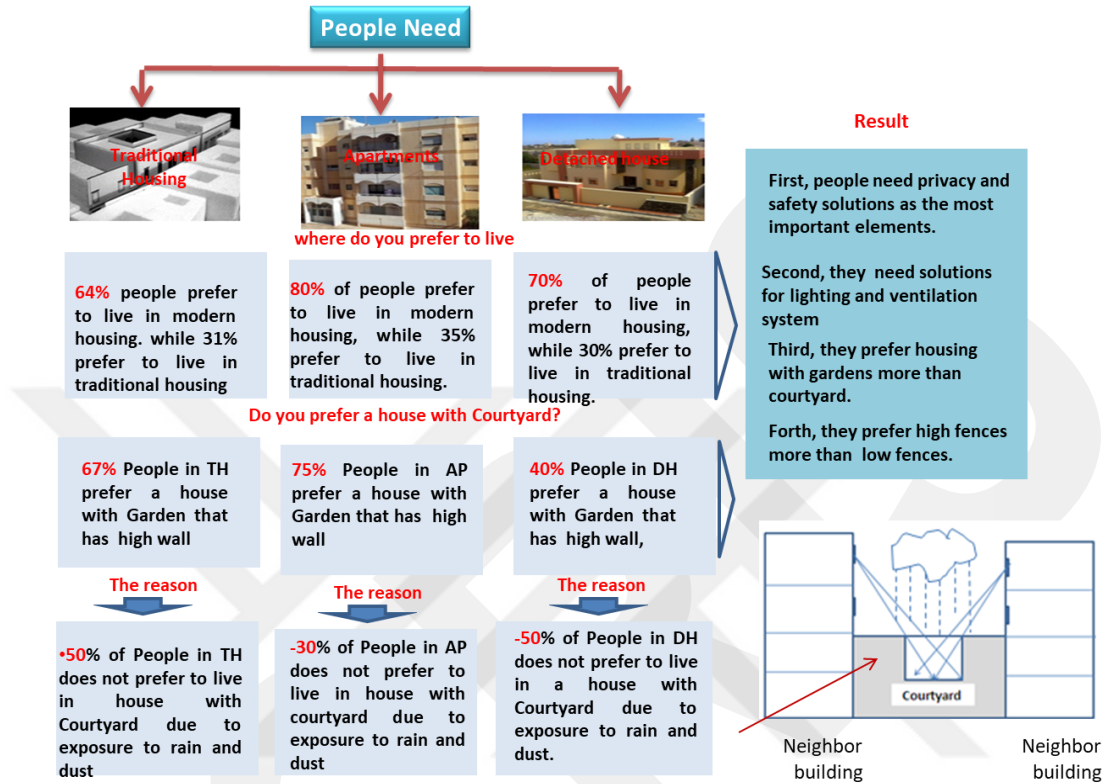
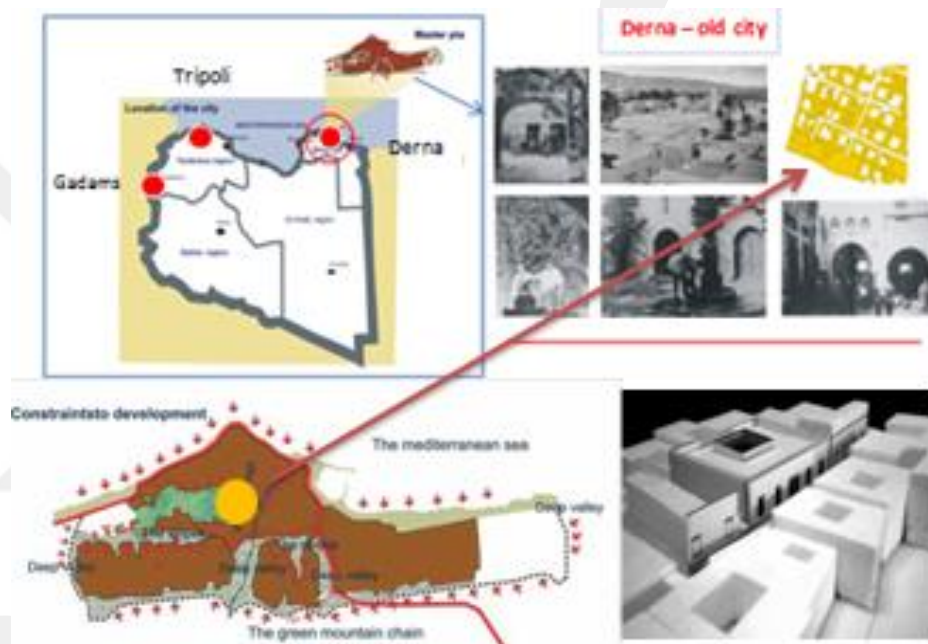


Figure 3.19: People's needs

## 3.2. Case study housing

### 3.2.1. Background of the case study area

**3.2.1.1. The location of the case study area;** The case study area of Derna City is located in northeastern Libya on latitude  $32^{\circ}$  north and longitude  $22^{\circ}$  east. It is bounded by the Mediterranean Sea in the north and Green Mountain in the south. The old traditional city is located in the center of the contemporary city and the case study housing is located near the old city in the three areas around it, as illustrated later.



**Figure 3.20:** Case study area – The traditional city was created in the past according to accurate natural rules and characteristics which have their own identity, culture and people's needs [45].

**3.2.1.2. City climate;** There are three main climatic regions in Libya: a hot and humid region located in the coastal area, a cold region located in the west south and east South Mountain, named Green Mountain, and a hot and arid region located to the south in the desert. The case study area is located in the hot, humid coastal area with an average temperature of  $19.4^{\circ}\text{C}$  and approximately 252 mm of annual rainfall.

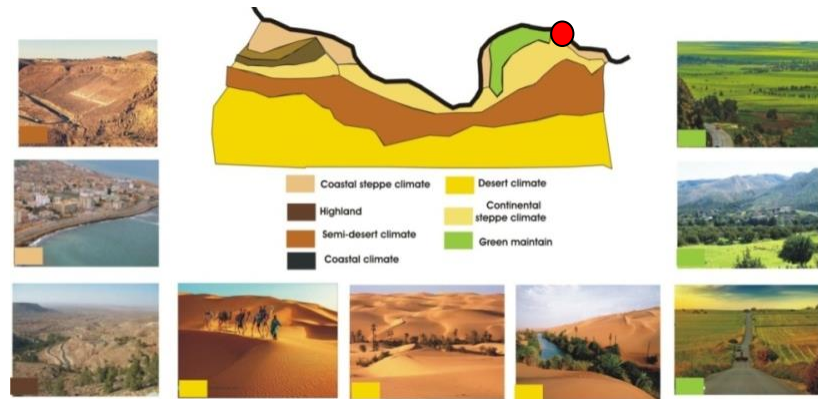


Figure 3.21: Map of climatic regions(www. Google. com)

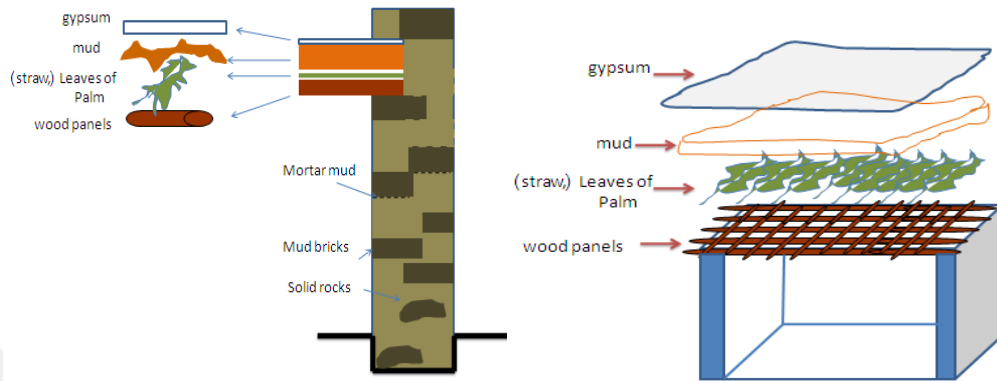
	January	February	March	April	May	June	July	August	September	October	November	December
Avg. Temperature (°C)	13.3	13.5	15.3	17.8	20.1	22.9	24.8	25.3	24.2	22.3	18.7	15.1
Min. Temperature (°C)	8.4	8.6	10.1	12.3	14.7	18	20.7	21.2	19.5	16.8	13.6	10.1
Max. Temperature (°C)	18.3	18.5	20.6	23.3	25.5	27.9	29	29.5	29	27.8	23.9	20.1

Figure 3.22: Temperatures of Derna City

### 3.2.1.2. State of housing in Derna

- a. **Traditional courtyard housing:** had been built before the advent of the Ottomans in 1711 by the local population, so they used natural local materials such as stones, trees, soil, etc. In accordance with their social needs and culture. In the following part, a brief summary of building descriptions and building structures are presented:
  - **Description of the building:** This type of building is residential and adjacent to buildings with one or two floors, featuring a central courtyard which is the main space for social interaction between family members. The courtyard provided a healthy environment for users with its natural ventilation, cooling, heating and lighting. Additionally, users created a natural environment by using plants and planted ceilings. Moreover, all the courtyards have windows opening onto the courtyard without affecting the privacy of the women. Finally, most of these houses had two courtyards, on being small and connecting the outside door with the guest room and shaded by a plant roof while the other courtyard is large due to its social role.
  - **Structure of the building :** The building structure consists of load-bearing walls. The structure holds not more than two floors. It was easy to build,

inexpensive and it can be built by local people. Wall thicknesses range from 40 mm to 50 mm, and were built with limestone and mortar. Most were painted in white and wood was used in a limited manner in the formation of roofs and openings.



**Figure 3.23:** Traditional housing materials in Derna City

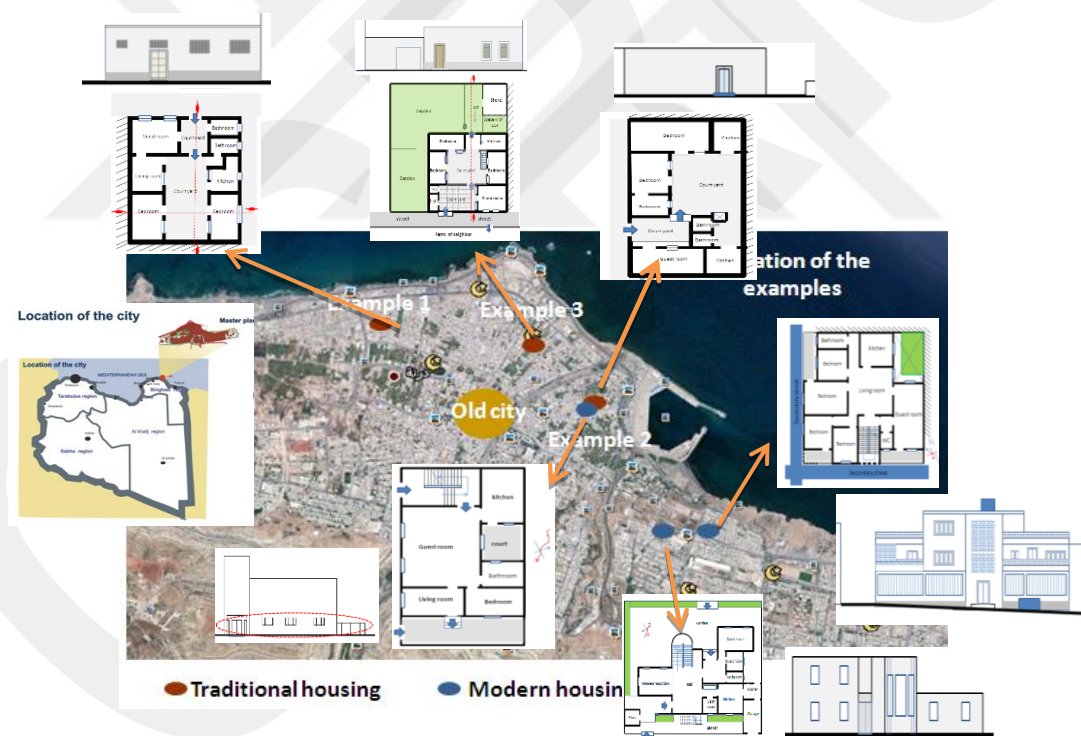
- b. Contemporary housing:** There are two kinds of contemporary housing: apartments and villas. These kinds of housing emerged after urbanization at the beginnings of the 1970s.
- **Description of building:** A villa mostly consists of two floors (it is common in this style to build a new apartment above the original building), while apartments consist of four to eight floors, including balconies and service courtyards.
  - **Structure of building:** The structure includes concrete columns, ceilings and floors as well as a concrete block spreader, as shown in the illustrations below.



**Figure 3.24:** Structure of the contemporary building (www. googl. com)

**Methodology;** In this study, traditional houses were selected for people who have experience of living in both traditional and contemporary houses. These houses were analyzed in terms of a number of factors and compared with contemporary housing. The aim of this section is to find suitable solutions for the design of nearly-zero energy housing for Libyan housing in the future. The methodology of a case study depended on analyses of three traditional and three contemporary houses. These houses were studied in terms of environmental and social factors, as shown in Figure 3.17.

This part of the study consists of environment questions which were asked in terms of lighting, ventilation, cooling and heating, and social questions of privacy and safety. The method depended on asking users about previous factors then comparing the traditional houses with contemporary houses in order to know the reasons for users choosing their answers.



**Figure 3.25:** Location of case study housing

### 3.2.2. Case Study House One (CSH.1)

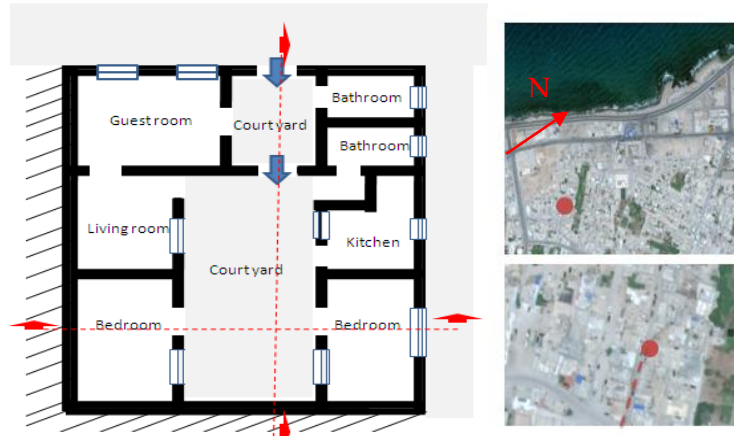


Figure 3.26: The plan

#### 3.2.2.1. Description of the buildings

- a. **Structure and local materials:** Case study house has one floor which is one of the most popular houses in the old city of Derna. This example is occupied by a single family. The main structure consists of walls which are connected to other houses on two sides (semi-detached housing), while the exterior walls face the narrow streets on two sides, as shown in figure above. The walls were built from local materials at a thickness of 40-50 cm, including limestone blocks with mortar made from sand and lime, while the roof was built from strong beams, stones and mortar.
- b. **Courtyard:** The interior courtyard was designed (1) to provide a private place for women to be away from strangers and (2) to protect people from the harsh climate of a hot humid region. Moreover, the courtyard is surrounded by two bedrooms, a living room, kitchen and bathroom. Finally, the big court is connected to a semi-private court that is also surrounded by a main entrance, a guest room and a small bathroom.

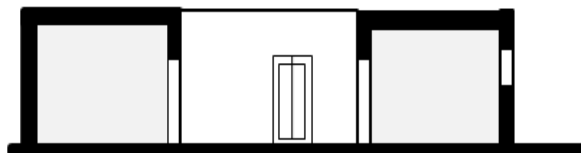


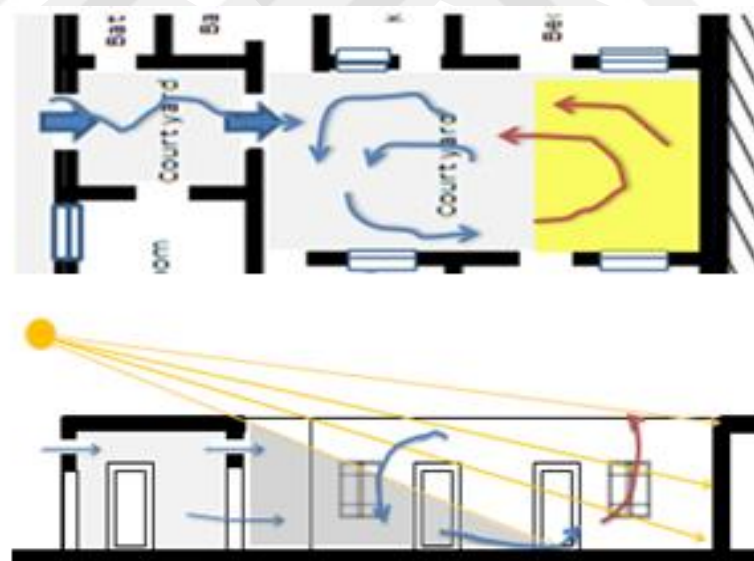
Figure 3.27: Section

### 3.2.2.2. Building analyses

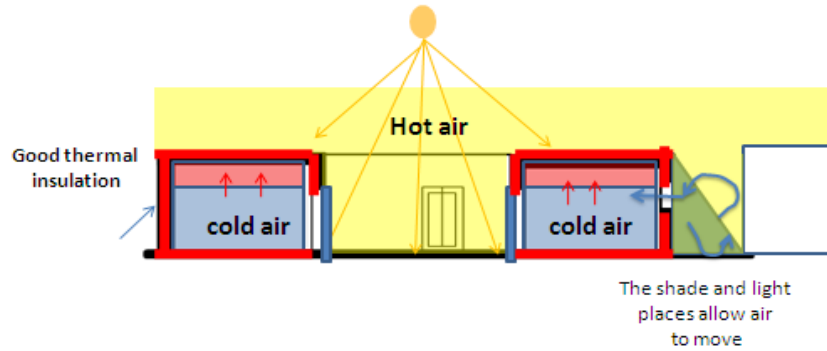
#### a. Environmental factors analyses

The housing study includes natural ventilation, cooling, heating and lighting studies provided by the building, as follows:

**-Ventilation and cooling:** Essential ventilation occurs by air movement through the doors and windows which open out to courtyard housing. The heights and widths of the windows opening into the courtyard housing are nearly 100 cm and 40 cm, respectively. The cooling of the space is a result of the cold air entering the room after a rise of warm air to the top of the courtyard. Furthermore, the wall thickness helps to keep the room air cool, especially after closing the windows. In the evening, the air of the inner courtyard (which is directly heated by the sun) begins to rise and gradually replaces with the cold air that came from the upper layers. Then the cool air gathers in the courtyard and enters the surrounding rooms.

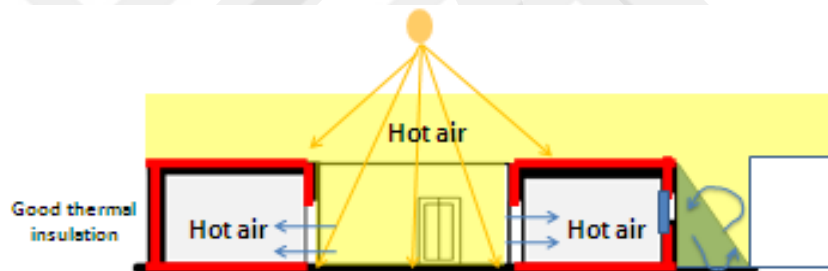


**Figure 3.28:** Ventilation and cooling system 1; the air circulates from places under shadow through the places under sunshine naturally. The air also moves from small court to large court.

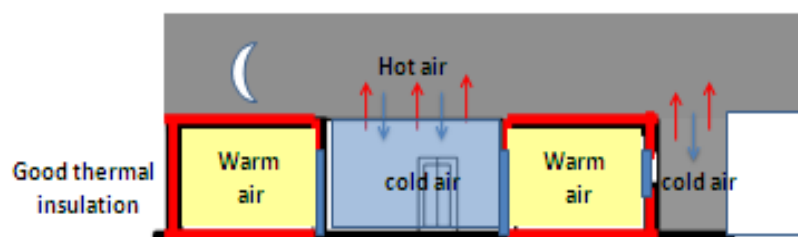


**Figure 3.29:** Ventilation and cooling system 2; during the day (summer); closing the windows helps to keep in cold air

**-Heating system:** The ways to heat spaces are, first, using heavy building materials that have good insulation, second, opening windows in daylight hours to allow hot air to enter the rooms. Users take advantage of this in their housing and they state that the level of heating is acceptable.



**Figure 3.30:** Heating system 1; daylight hours (winter)



**Figure 3.31:** Heating system 2; night time (winter); closing the windows during the day helps to keep in warm air.

**-Lighting system:** The interior courtyard provides natural daylight during the day. This light comes through windows and doors, which provides all rooms with the advantage of good lighting during the day.

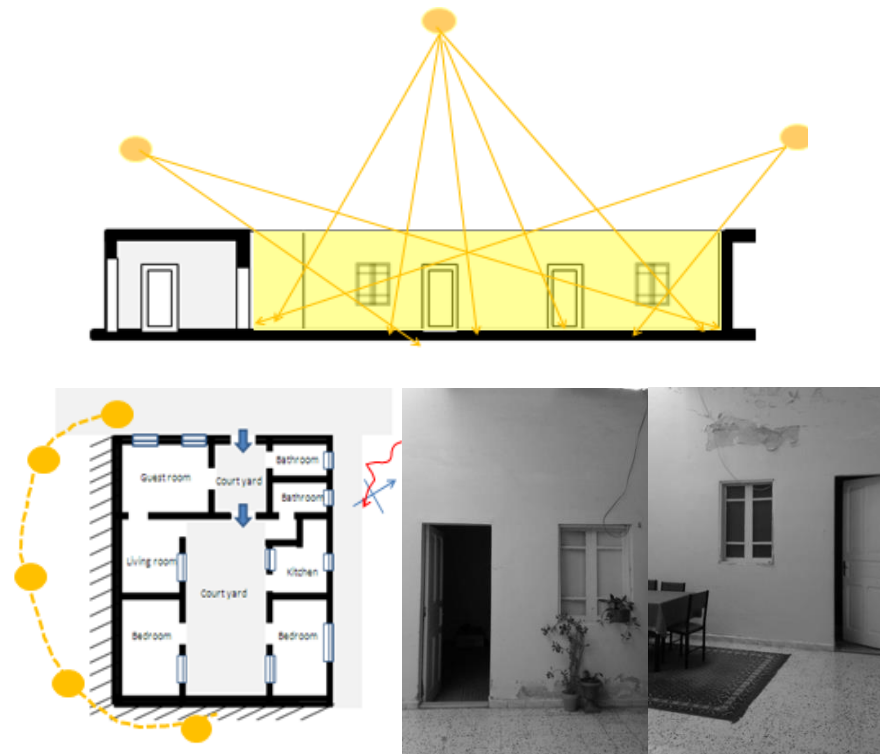


Figure 3.32: Lighting system; courtyard providing good light for every room

### b. Social factors analyses

**-Privacy:** There is a semi-private courtyard that offers privacy to the guest. There is also a men' room with high windows facing the main street. The owner of this building is not satisfied with the privacy of these rooms because the doors of rooms are facing each other in the center of housing.

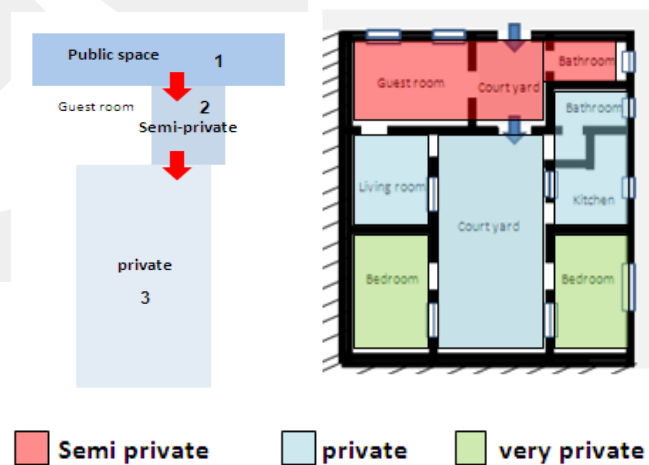
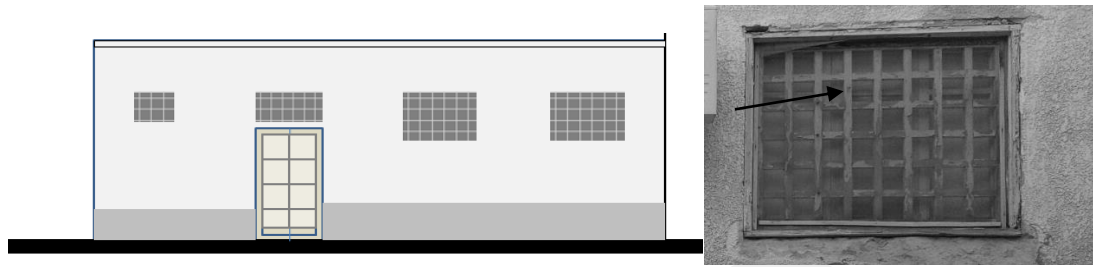


Figure 3.33: Privacy of indoor spaces

**-Security system:** The structure of the building and the lack of windows to the outside provide security to an acceptable degree.

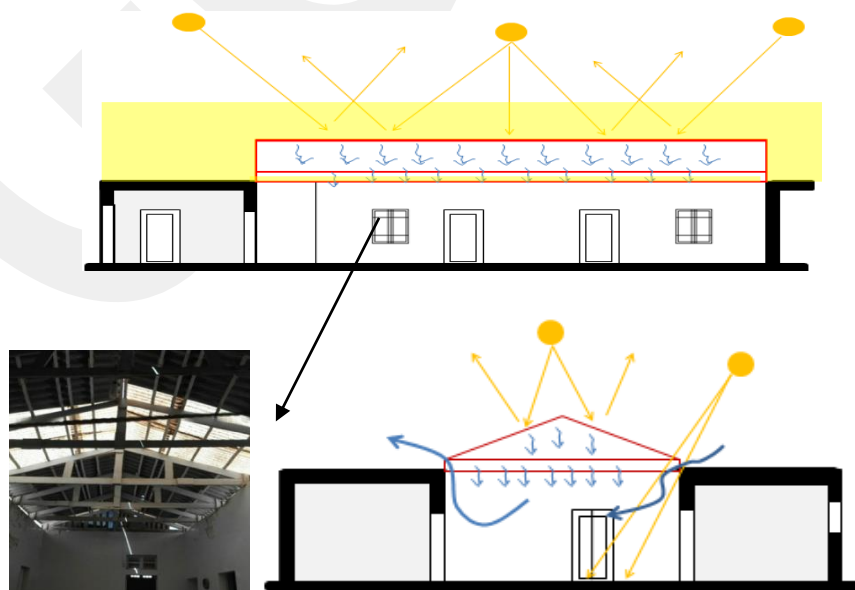


**Figure 3.34:** Security system; the external façade; the windows are higher than the level of pedestrians

### c. Users' needs

Despite the success of the central courtyard in cooling, heating and providing natural lighting, users or owners of this housing do not want to live in courtyard houses. According to their answers, the form of the courtyard is display for the rain in cold winter and the dust in the summer. Furthermore, for the case of room organization, the respondents stated that there is no privacy for the bedroom spaces because all the doors are opened in one space, which affects the privacy of the family.

**-Owner modification:** The courtyard was covered with wooden beams and aluminum panels. This form has four opening sides, as seen in Figure 3.29. These openings allow air to move, but they do not allow direct rain to enter. Furthermore, the owner intends to close the yard in the future.

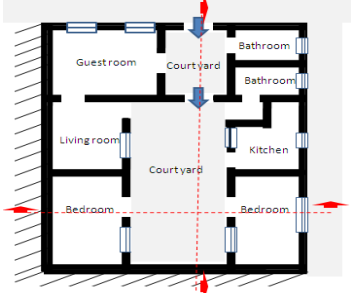
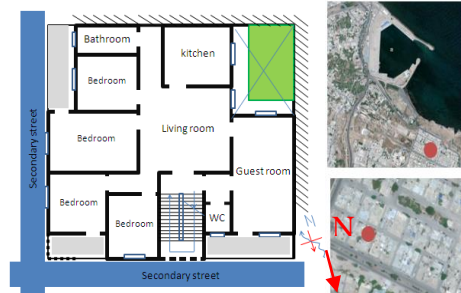
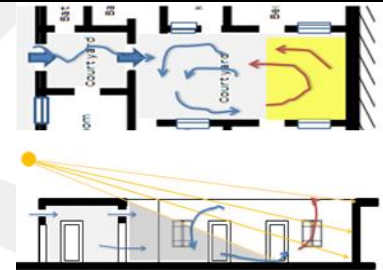
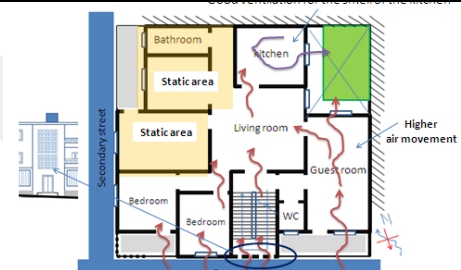
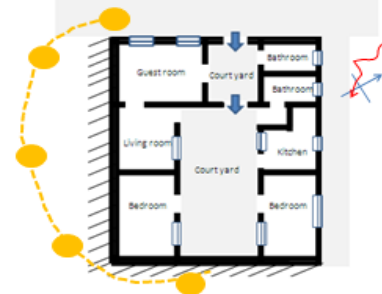
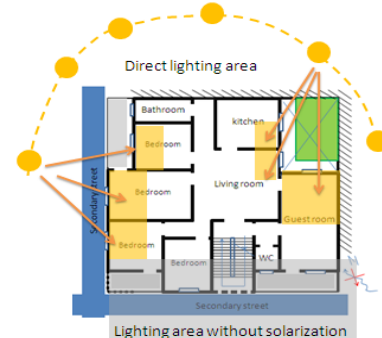


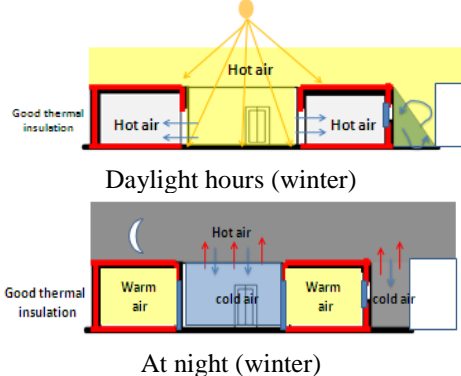
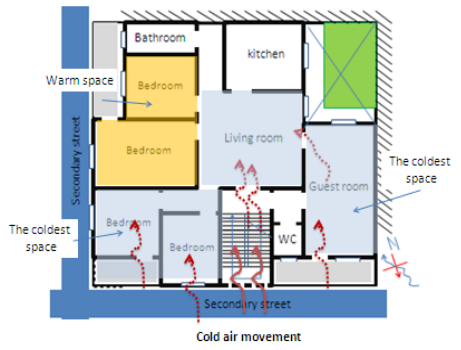
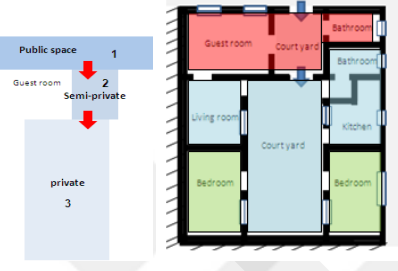
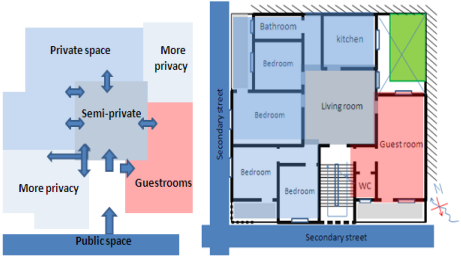
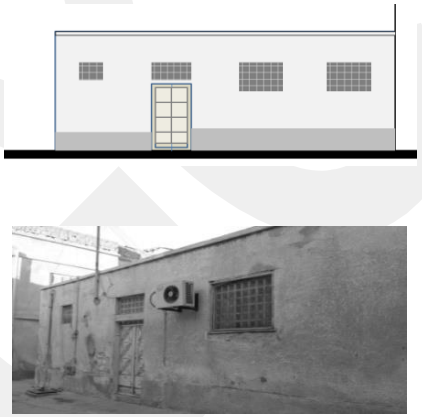

**Figure 3.35:** Owner's modification; the courtyard is covered with aluminum panels

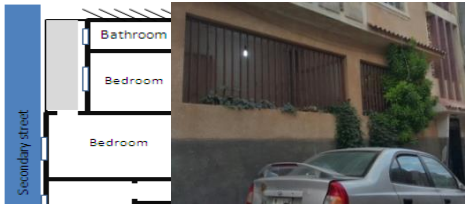
### **3.2.2.3. Conclusions (results according to the users' answers)**

- Traditional housing has good natural lighting and heating systems.
- The ventilation is good and the rooms are cool all summer in traditional housing; however, users claimed that contemporary housing is better than traditional housing in terms of ventilation and cooling systems.
- To compare with traditional homes in the winter, contemporary housing is very cold.
- Users prefer more to live in contemporary housing rather than traditional housing.
- The user does not prefer housing with a courtyard; he prefers a house with an outdoor balcony because the yard brings dust and rain.

**Table 3.8;** Comparison types between traditional and contemporary housing

Case Study House One (CSH.1)		
Comparis on type		
	Traditional house	
	Contemporary house	
Architectural characteristics	 <ul style="list-style-type: none"> <li>• Built after the 1970s</li> <li>• Traditional style</li> <li>• One floor</li> <li>• It has a central courtyard that has a social and environmental function.</li> </ul>	 <ul style="list-style-type: none"> <li>• Modern style built in the 1970s</li> <li>• Two floors</li> <li>• It has a service courtyard.</li> </ul>
Structure	<p>The structure is a bearing wall built from limestone blocks with mortar made from sand and lime. The roof was built with strong beams, stones and mortar.</p>	<p>A concrete structure system that consists of concrete columns, a roof and a floor. The walls are built with concrete blocks covered with cement mortar.</p>
ventilation and cooling	 <p>The shady and light places allow air to move due to the cold air moving from a low pressure area to a low pressure area.</p>	 <p>There is good ventilation due to air flows through the windows and stairs.</p>
Lighting	 <p>The traditional house is better than the contemporary house in providing natural lighting.</p>	 <p>Contemporary housing has good natural lighting during the day.</p>

<p style="writing-mode: vertical-rl; transform: rotate(180deg);"><b>Heating</b></p>	 <p>Daylight hours (winter)</p> <p>At night (winter)</p> <p>Closing the windows during the day helps to keep in warm air. The traditional house is better than the contemporary house.</p>	 <p>The movement of cold air creeps through the gaps of doors and windows, so that makes the rooms very cold.</p>
<p style="writing-mode: vertical-rl; transform: rotate(180deg);"><b>privacy</b></p>	 <p>The owner of this house is not satisfied with the privacy of these rooms because it is claimed that the doors face each other in the center of house.</p>	 <p>The user prefers this system in the functional distribution of rooms.</p>
<p style="writing-mode: vertical-rl; transform: rotate(180deg);"><b>privacy</b></p>	 <p>The main face provides a high level of privacy.</p>	 <p>However, the modern house is open to the outside more than a traditional home, so users used glass only while keeping the outer packing closed.</p>

<p style="text-align: center;"><b>Safety</b></p>	<p>Traditional houses are better than contemporary houses in safety systems.</p>	 <p>The north faced is safe, but the east face is not because the terrace is low and unprotected.</p>
<p style="text-align: center;"><b>Results according to the users' answer</b></p>	<ul style="list-style-type: none"> <li>○ Traditional housing has good lighting and heating systems.</li> <li>○ Contemporary housing has good ventilation and cooling.</li> <li>○ Ventilation is good and the rooms are cool all summer in traditional housing; however, users claimed that contemporary housing is better than traditional housing in terms of ventilation and cooling systems.</li> <li>○ In comparison with traditional homes in the winter, contemporary housing is very cold.</li> <li>○ Users prefer contemporary housing in which to live more than traditional housing.</li> <li>○ The user does not prefer housing with a courtyard; he prefers a house with an outdoor balcony because the yard brings dust.</li> </ul>	

### 3.2. 3. Case Study House two (CSH.2)



Figure 3.36: The plan of case study housing 2

#### 3.2.3.1. Description of the building

- a. **Structure and Materials:** The system depended on connected walls without columns, known as load-bearing walls. The external wall thickness ranged from 40 cm to 60 cm and the roof was about 3 m high. The roofs were made from timber, sandstone and limestone. Most of the timber came from palm trees.
- b. **Courtyard:** There were two courtyards. The main courtyard was rectangular in shape and every room opened out to the courtyard by the longer side which had medium-sized windows. The second court faced the entrance, which was the guest entrance. Every room was rectangular shaped.

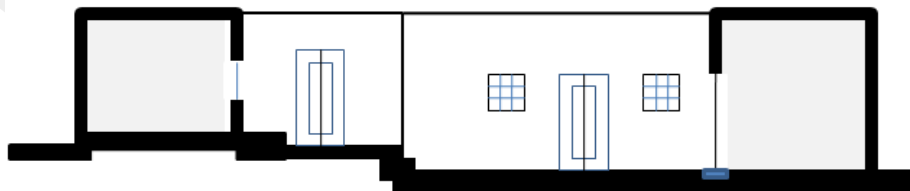
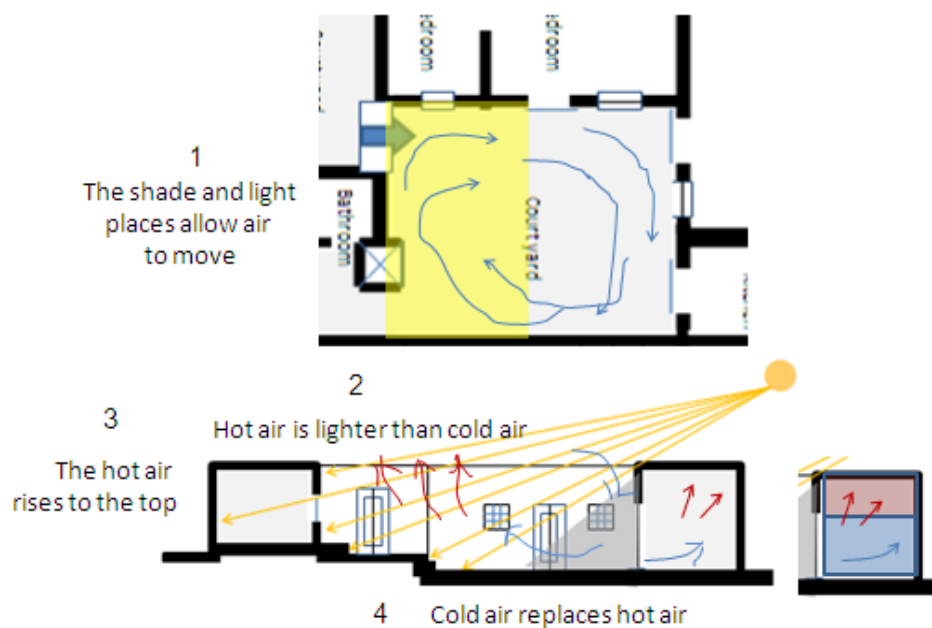


Figure 3.37: Section of case study housing 2

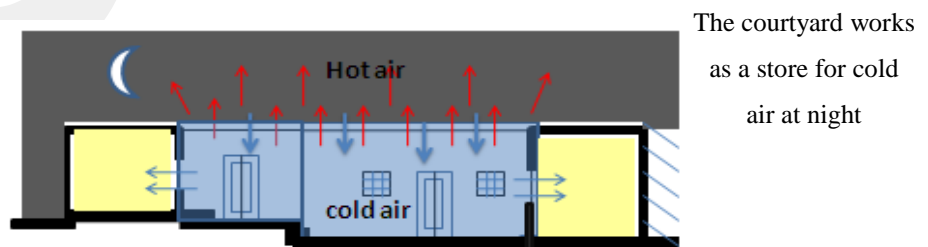
### 3.2.3.2. Building analyses

#### a. Environmental factors

**-Ventilation and cooling:** The thickness of the walls and the kind of materials used helped to insulate the building from high temperatures. The shaded and light areas in the courtyard allowed the air to move and ventilate the rooms. According to user answers, the rooms were cool in the summer and had good ventilation, which created a comfortable indoor climate.

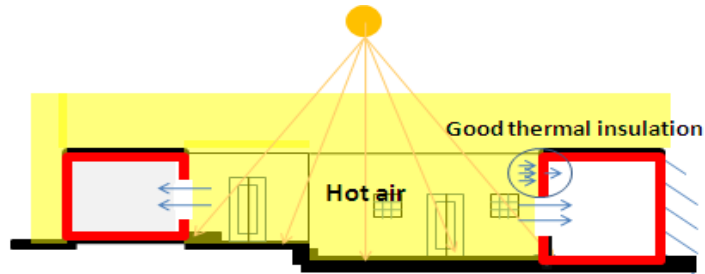


**Figure 3.38:** Ventilation and cooling system 1; during daylight hours (summer); closing the windows during the day helps to keep in cold air.

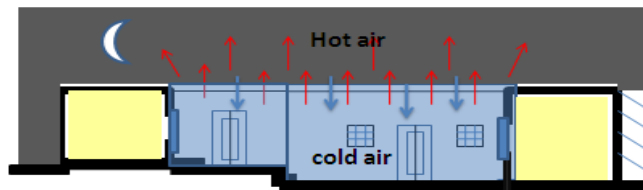


**Figure 3.39:** Ventilation and cooling system 2; at night (summer); opening the windows to allow cold air to enter

**-Heating system:** In the afternoon, hot air gathers in the courtyard; the doors and windows of the rooms are opened to allow the hot air to move inside. Users would close the windows and doors at night to keep in the hot air.

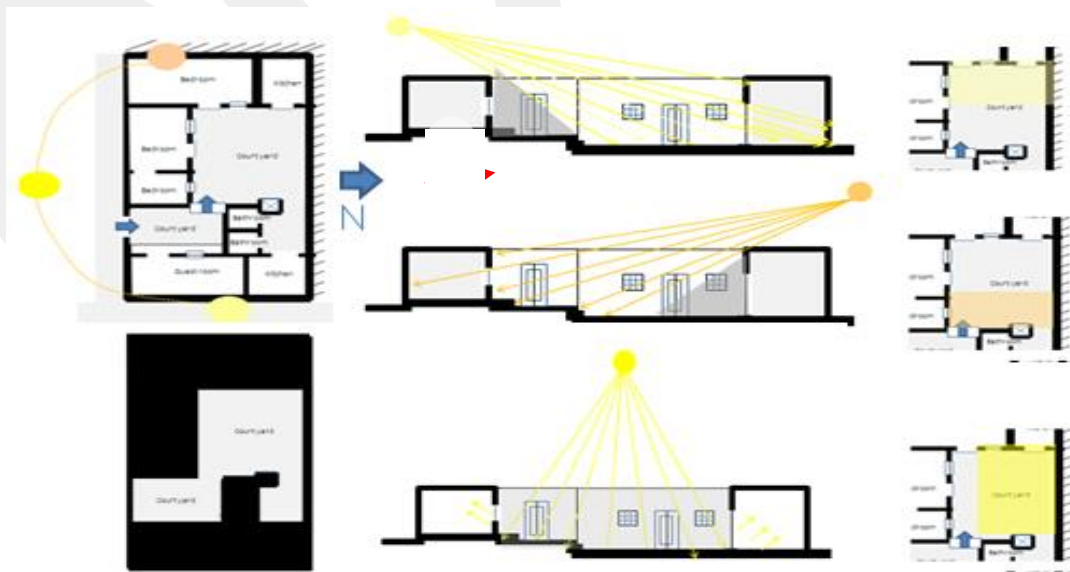


**Figure 3.40:** Heating system 1; in the morning (winter); opening the windows to allow air cold to enter.



**Figure 3.41:** Heating system 2; at night (winter); closing the windows during the day helps to keep in cold air.

**-Lighting:** Natural light and sunshine come through the courtyard to the room spaces through the tall windows and doors.



**Figure 3.42:** Lighting of courtyard

## b. Social factors

This section discusses privacy and security systems in traditional courtyard houses.

**-Privacy:** An indirect connection between small and large courtyards provides privacy for all family rooms. Moreover, there are no windows open on the street.

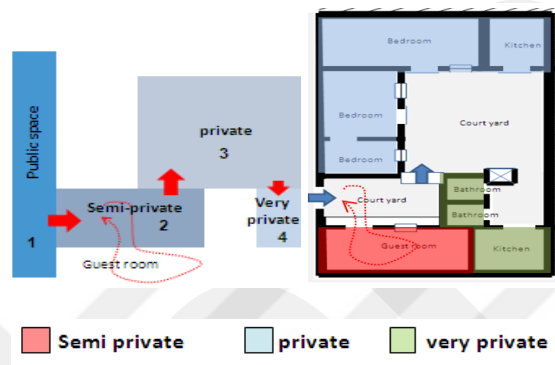


Figure 3.43: Levels of privacy

**-Security:** The building design reflected people's need for the provision of safety and privacy in a simple manner. However, if the house has two floors, it will be more saving than one floor as users said.

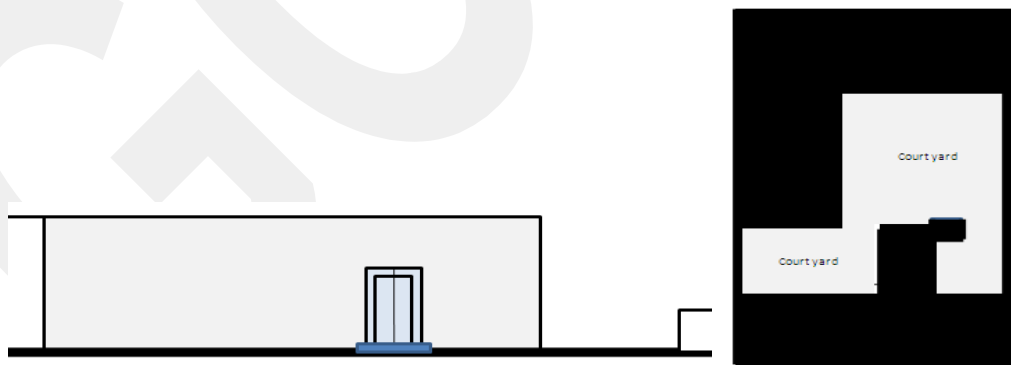



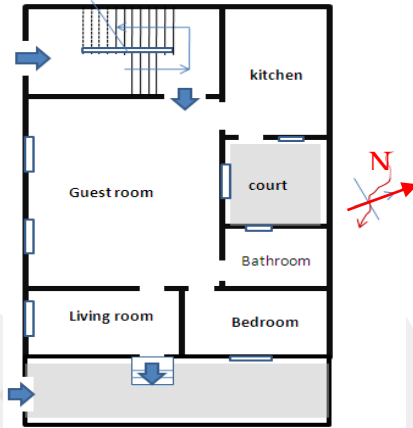
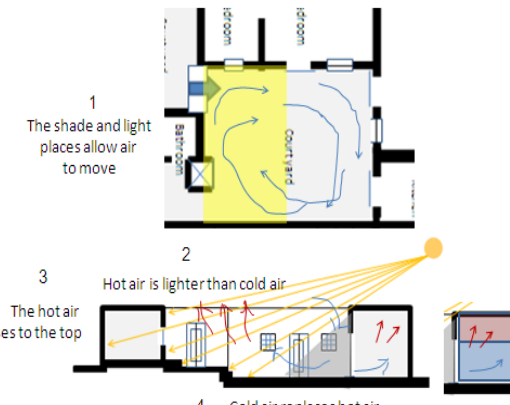
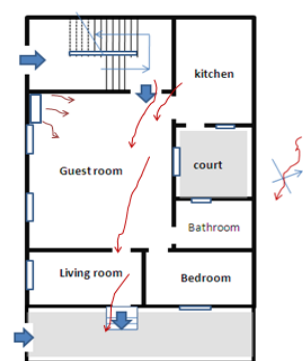
Figure 3.44: The form of the facade; there are no windows overlooking the street

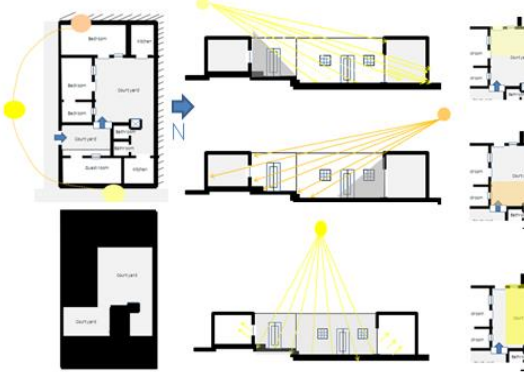
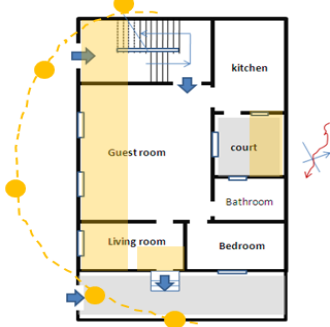
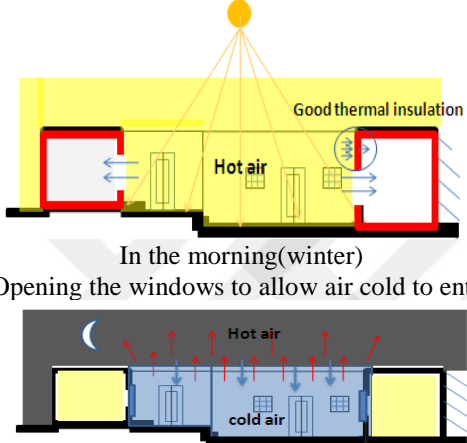
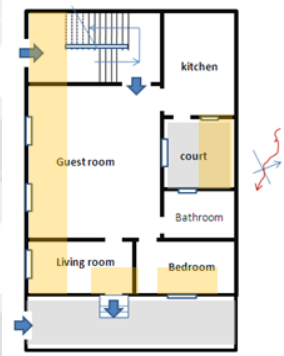
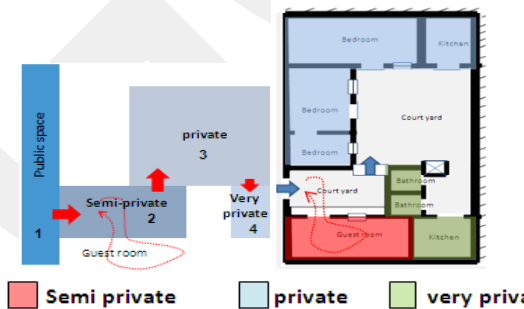
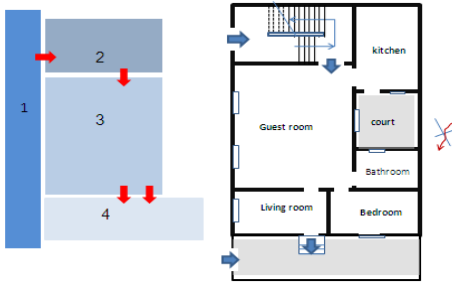
**-Owner's modification:** The courtyard has been covered with a plastic roof with wooden supports so to protect the building from rain in the cold winters.


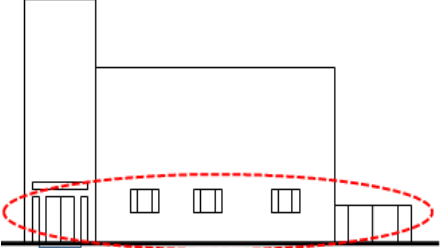

### **3.2.3.3. Results according to users' answers**

- The house is in a high level of natural lighting, ventilation, cooling and heating.
- Traditional local materials helped to cool the rooms in the summer and heat them in the winter due to their thermal mass.
- The court yards achieved good privacy for women to be away from strangers.
- Wall thickness helps to provide good insulation.
- The rooms are ventilated and away from the smells of the kitchen.
- Contemporary houses have bad ventilation and are considered to be as dark spaces.
- Users prefer more to live in traditional housing rather than contemporary housing.
- The only reason to demolish a building is due to the inability of a traditional building to expand vertically.

**Table 3.9:** Comparison types between traditional and contemporary housing

Case study housing 2 (CSH.2)		
Comparison type	Traditional house	Contemporary house
Architectural characteristics	 <ul style="list-style-type: none"> <li>○ Traditional style</li> <li>○ Inward openness</li> <li>○ The court has an environmental and social function</li> <li>○ One floor</li> </ul>	 <ul style="list-style-type: none"> <li>○ Modern style</li> <li>○ Outward openness</li> <li>○ The court has only a service function</li> <li>○ Three floors</li> </ul>
Structure	<p>Load-bearing walls; the thickness of the external walls ranges between 40 cm and 60 cm, the roof is about 3 m high. The roofs consist of timber, sandstone and limestone. Most of the timber is from palm trees.</p>	<p>Concrete structure; consisting of concrete columns, concrete roof and concrete floor</p>
Ventilation and cooling	 <p>From user answers, the rooms were cool in the summer and had good ventilation, which creates a comfortable indoor environment.</p>	 <p>An air conditioner is used for cooling; users are not comfortable with the ventilation of the rooms because kitchen fumes enter other spaces.</p>

<p style="writing-mode: vertical-rl; transform: rotate(180deg);"><b>Lighting</b></p>	 <p>Natural light and sunshine come through the courtyard into the room spaces through the windows and doors, so users prefer the interior courtyard because it provides good natural lighting.</p>	 <p>Although all the space receives direct solar radiation, users prefer the lighting provided by the inner courtyard.</p>
<p style="writing-mode: vertical-rl; transform: rotate(180deg);"><b>Heating</b></p>	 <p>In the morning (winter) Opening the windows to allow air cold to enter</p> <p>At night (winter) Closing the windows during the day helps to keep in cold air.</p> <p>In the afternoon, hot air gathers in the courtyard; the doors and windows of the rooms are opened to allow hot air move into them. Users would close the windows and doors at night to keep in the hot air.</p>	 <p>Despite routing to the south providing warmer spaces that allow the sun to enter in the winter, users prefer the warmth of the traditional house due to the thermal mass of the local materials used at the time.</p>
<p style="writing-mode: vertical-rl; transform: rotate(180deg);"><b>Privacy</b></p>	 <p><b>Level of Privacy</b></p> <p>Users prefer the privacy of traditional housing more than modern housing.</p>	 <p>There is no privacy because every space is open to the central space and there are no spaces for male guests.</p>

<p style="writing-mode: vertical-rl; transform: rotate(180deg);"><b>Safety</b></p>	 <p>Compared to a contemporary house, the inner courtyard is not safe in the case of one-storey houses.</p>	  <p>Contemporary housing is safer than traditional housing.</p>
<p style="writing-mode: vertical-rl; transform: rotate(180deg);"><b>Results according to users' answers</b></p>	<ul style="list-style-type: none"> <li>○ The housing has a high level of lighting, ventilation, cooling and heating.</li> <li>○ Building materials helped to cool the rooms in the summer and heat them in the winter.</li> <li>○ The courtyards provide good privacy for women to be away from strangers.</li> <li>○ Wall thickness provides good insulation.</li> <li>○ The rooms are ventilated and away from the smells of the kitchen.</li> <li>○ The contemporary house has bad ventilation and is considered a dark space.</li> <li>○ Users prefer more to live in traditional housing rather than in contemporary housing.</li> </ul> <p>The only reason to demolish a building is due to the inability of a traditional building to expand vertically.</p>	

### 3.2.4. Case Study House Three (CSH.3)

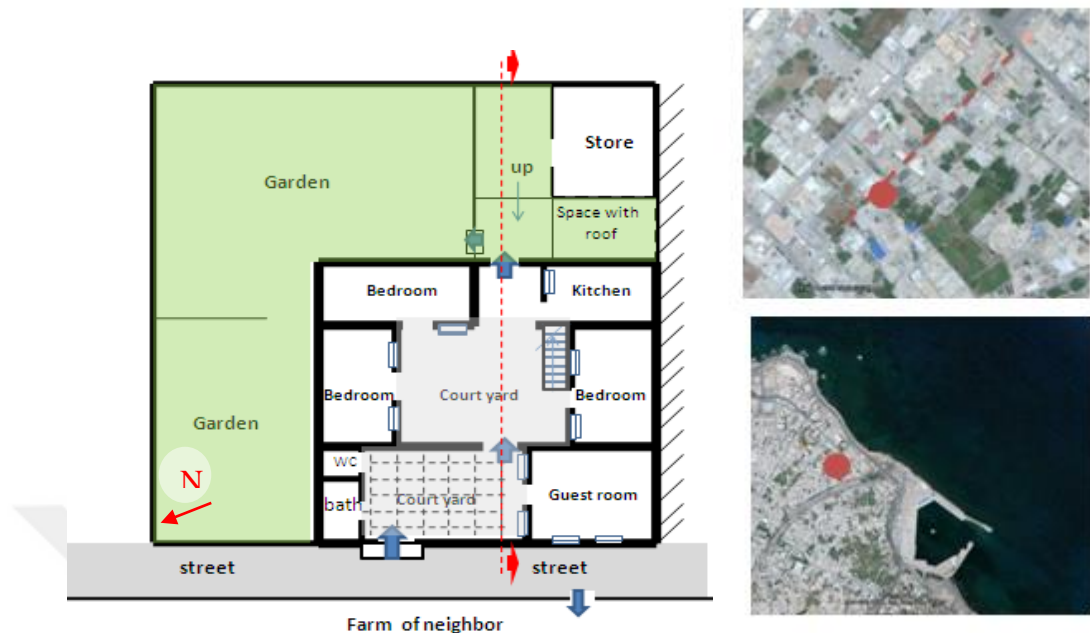


Figure 3.45: Plan and location of the housing

#### 3.2.4.1. Description of the building

- Structure and Materials:** The structure consists of load-bearing walls with the roof made from timber, sandstone and limestone. However, the out store was built with a timber wall and a timber roof.
- Courtyard:** There are two courtyards; the central one is the main space used as living room, especially for the interaction between women and family members and her guests.

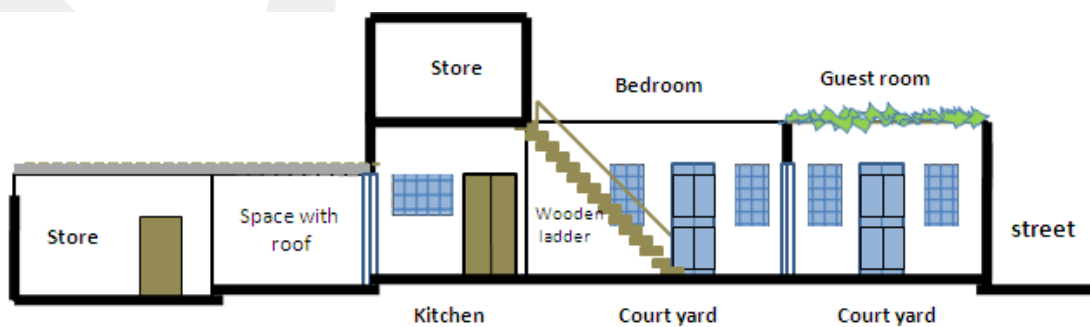


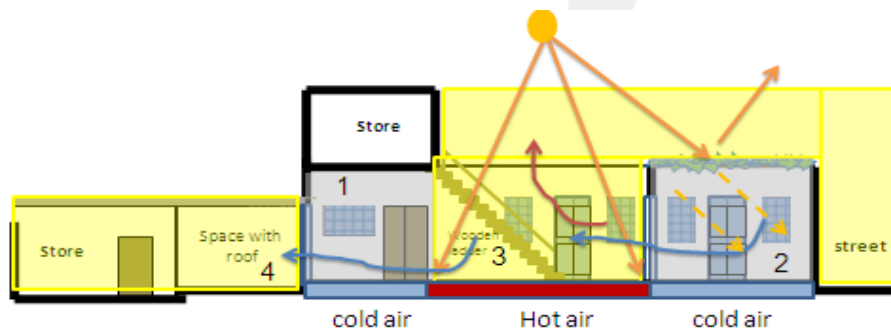
Figure 3.46: Section of case study housing 3

### 3.2.3.2. Building analyses

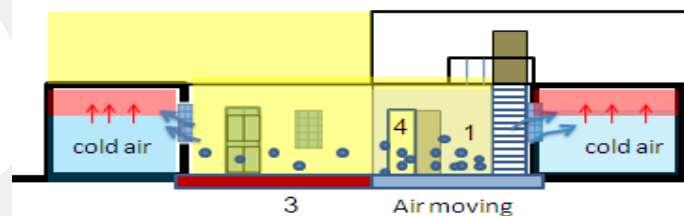
#### a. Environmental factors analyses

Environmental studies for this example include ventilation, cooling, heating and lighting.

**-Ventilation and cooling:** Natural ventilation is found in this kind of housing in which the courtyard works as lungs for all the interior spaces. Inner courtyards enhance ventilation and cooling systems (these will be analyzed later).

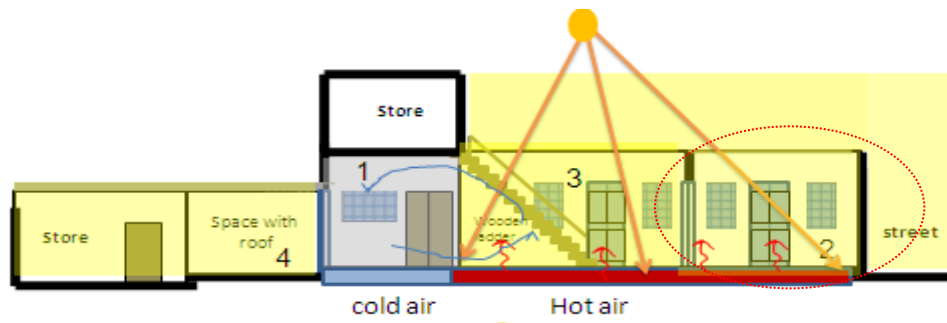


**Figure 3.47:** Ventilation and cooling 1; the two courtyards help air movement because courtyard 3 is sunny and courtyard 2 is shady.

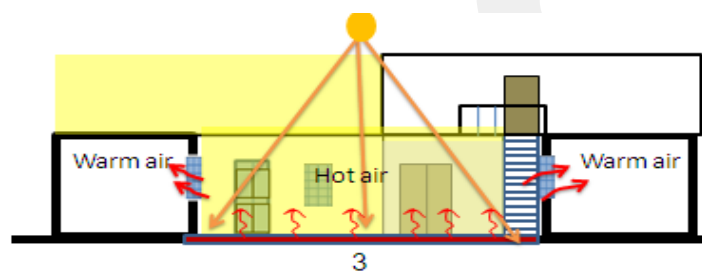


**Figure 3.48:** Ventilation and cooling 2; air moves from the shady place to the sunny place.

**-Heating system:** The thickness of the walls helps to keep rooms warm, especially when the windows are closed, as stated by users.



**Figure 3.49:** Heating system 1; in the winter, courtyard 2 is sunny and the spaces have more hot air.



**Figure 3.50:** Heating system 2; the hot air is collected in the yard during the day and then enters the rooms through windows.



**Figure 3.51:** Heating system 3; in the winter at night, cold air collects in the courtyard and the good isolation of the walls helps to isolate the internal space from the external space.

**-Lighting:** The central courtyard allows solar radiation to enter the rooms, especially at the southern façades. Every room has good lighting coming through the windows and doors, as stated by users.

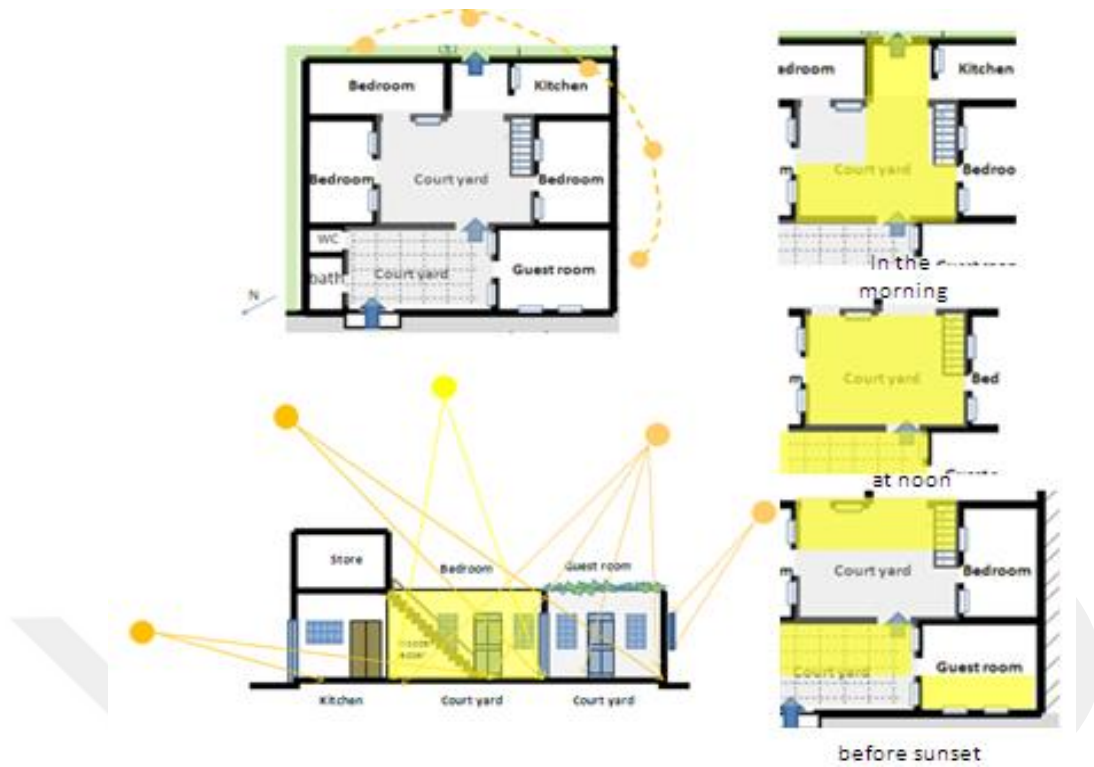


Figure 3.52: Lighting of the courtyard

### b. Social factors

**-Privacy:** The privacy of the old society helped to create a special space for women to live away from strangers. For instance, there were two courtyards, the first of which connected the main entrance with guest room, while the central space was used for the social interaction of all family members.

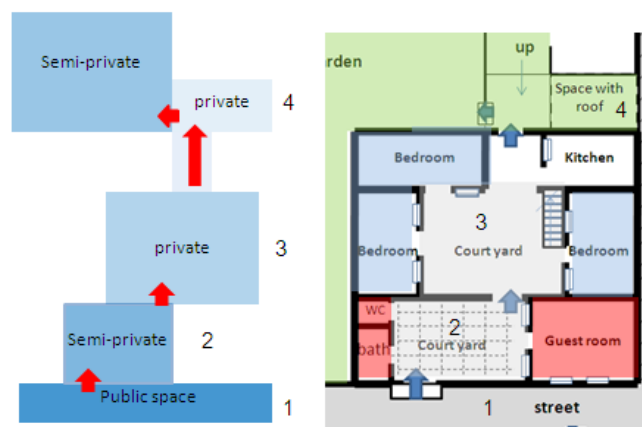
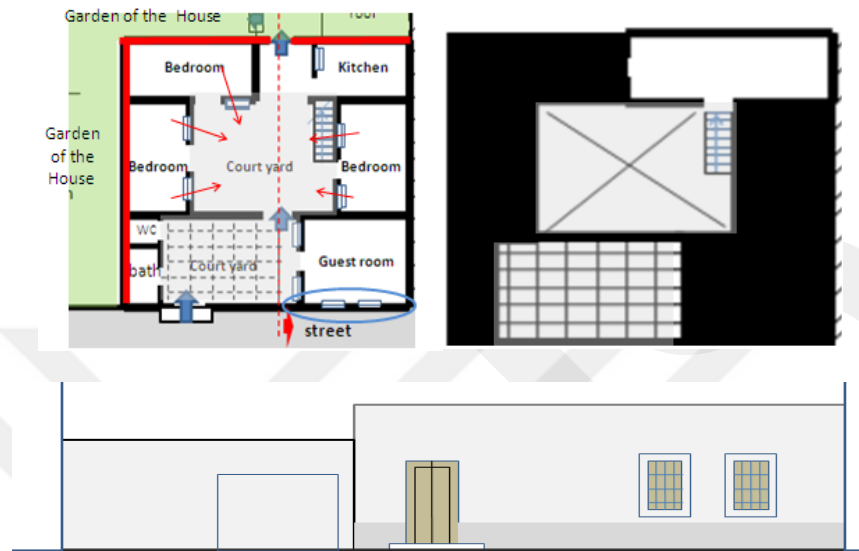


Figure 3.53: Level of Privacy

**-Safety system:** The house has the same characteristics of the traditional local house such that, except for the guest space, there is opening towards internal space. As consequence, this made the house very safe by reducing openings to the outside.

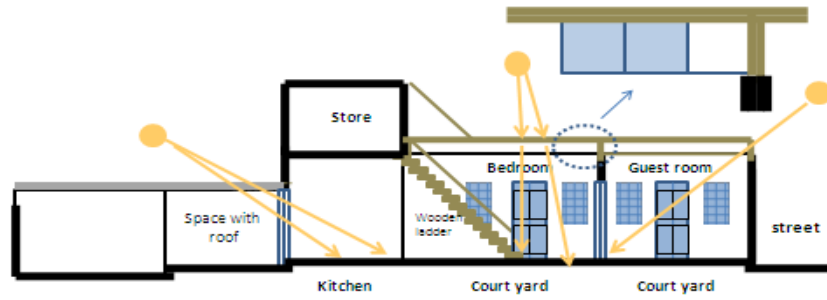


**Figure 3.54:** Safety system; users are satisfied with the level of privacy

### c. Users' needs

In addition to the two previous examples, people's needs have changed over time and the central courtyard has become an undesirable element in modern life. Therefore, users of this housing expressed their needs by closing the courtyard of their housing.

**-Owners' modifications:** Modern materials have been added to the existing building in order to meet users' needs. These needs firstly include owners closing middle courtyards partly with wooden materials which are resistant to the climatic conditions. The reason behind space closures is the owners' unwillingness to expose their spaces to the rain and dust, as stated by the respondents. Secondly, the owners expanded the size of the kitchen space. Finally, the small area at the back of the garden has been taken for car parking. As a result, users of the house have done what they wanted from this kind of traditional housing to achieve their modern needs.

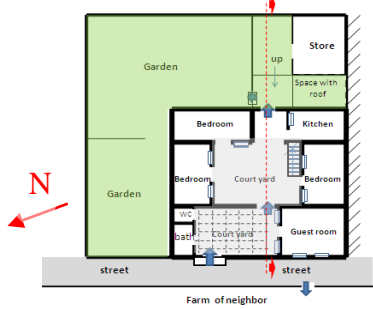
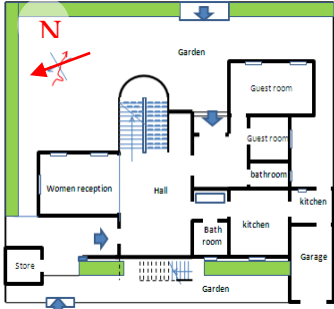
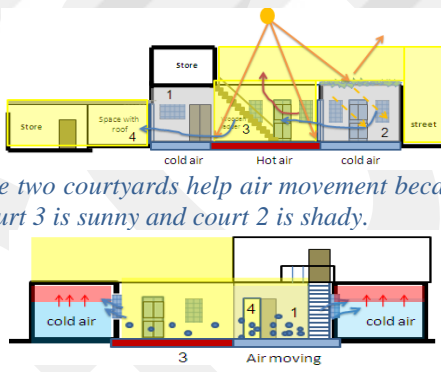
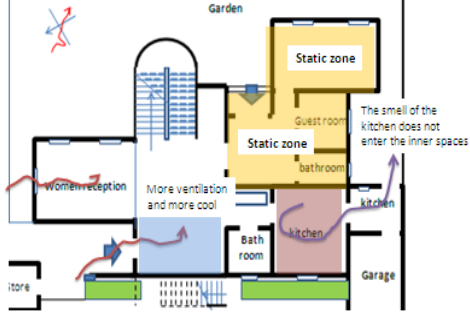

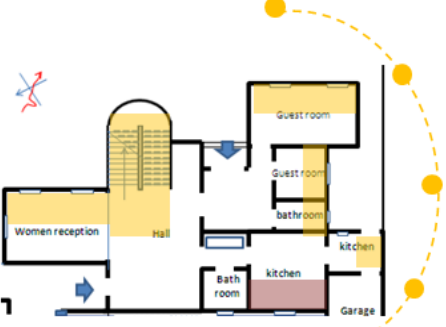


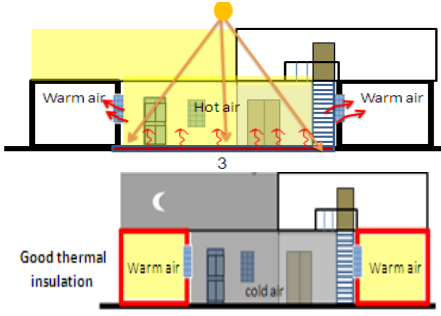

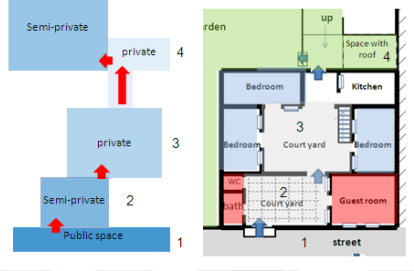
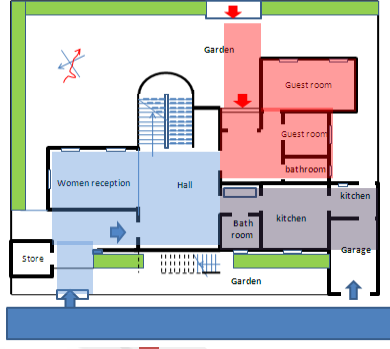
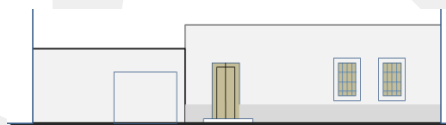
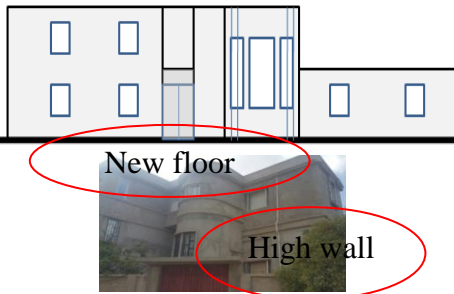
**Figure 3.55:** Owner's modification; new modern materials added to traditional housing

### 3.2.4.3. Results according to users' answers

- Traditional housing is better than contemporary housing in terms of lighting, ventilation, cooling and heating systems.
- The reason for a good indoor environment, as stated by users, is that building materials and courtyard form.
- The traditional house is better than the contemporary house in term of privacy.
- There are no disadvantages of the traditional housing except for the inability of the house to have new floors added.
- Users prefer to live in traditional housing with courtyards.
- Users understood the environmental role of courtyards after they moved into contemporary housing.

**Table 3.10:** Comparison types between traditional and contemporary housing

<b>Third Case Study House three (CSH.3)</b>	
Comparison on types	<div style="display: flex; justify-content: space-around;"> <div style="text-align: center;"> <p><b>Traditional house</b></p> </div> <div style="text-align: center;"> <p><b>Contemporary house</b></p> </div> </div>
Architectural characteristics	<div style="display: flex; justify-content: space-around;"> <div style="width: 45%;">  <ul style="list-style-type: none"> <li>Traditional style</li> <li>One floor with one room on level one features by large back garden</li> <li>There are two courtyards</li> </ul> </div> <div style="width: 45%;">  <ul style="list-style-type: none"> <li>Modern style with garden and a high wall</li> <li>Two floors</li> </ul> </div> </div>
The structure	<div style="display: flex; justify-content: space-between;"> <div style="width: 45%;"> <p>The structure consists of load-bearing walls and a roof that made from timber, sandstone and limestone. However, the out store was built from a timber wall and timber roof.</p> </div> <div style="width: 45%; text-align: center;"> <p>Concrete structure system</p> </div> </div>
Ventilation and cooling	<div style="display: flex; justify-content: space-between;"> <div style="width: 45%;">  <p><i>The two courtyards help air movement because court 3 is sunny and court 2 is shady.</i></p> <p><i>Air moves from the shade to sunny places.</i></p> <p>The inner courtyard enhances ventilation and cooling (which is analyzed later).</p> </div> <div style="width: 45%;">  <p>The spaces overlooking the northern and northwestern façades are characterized by good ventilation while the southern rooms are semi-static.</p> </div> </div>
Lighting	<div style="display: flex; justify-content: space-between;"> <div style="width: 45%;">  <p>Every room has good lighting from the windows and doors.</p> </div> <div style="width: 45%;">  <p>Every room has a good distribution of sunshine.</p> </div> </div>

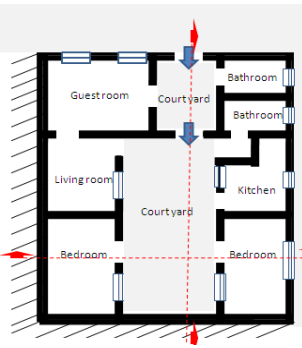
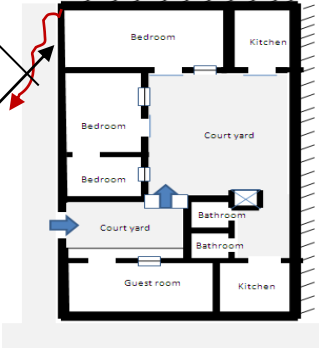
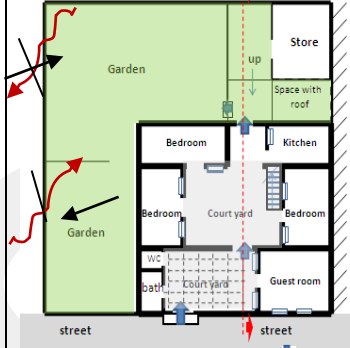
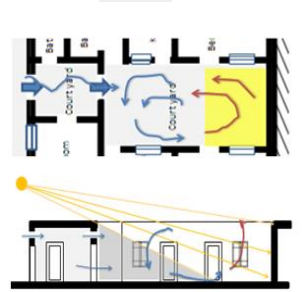
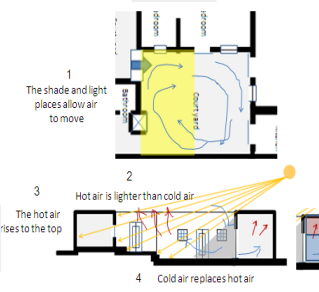
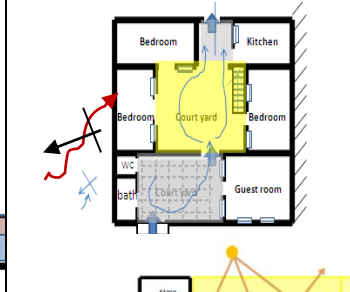
<p style="text-align: center;"><b>Heating</b></p>	 <p>Wall thickness helps to keep rooms warm, especially when any windows are closed.</p>	 <p>The traditional house is better than the contemporary house with regard to the heating system due to good insulation of the structure and local materials.</p>
<p style="text-align: center;"><b>Privacy</b></p>	 <p>There are two courtyards; the first is connected to the main entrance with a guest room, while the central space is used for social interaction of all family members.</p>	 <p>■ Space for men ■ Space for women ■ Service space</p>
<p style="text-align: center;"><b>Security</b></p>	 <p>Inward openness, high windows</p>	 <p>New floor High wall Low windows with protection</p>
<p style="text-align: center;"><b>According to the users' answer</b></p>	<ul style="list-style-type: none"> <li>○ The traditional housing is better than modern housing in lighting, ventilation, cooling and heating system.</li> <li>○ The reason for good indoor environment, as one user said, is that building materials and courtyard form.</li> <li>○ The traditional home is better than the modern house in terms of privacy.</li> <li>○ There are no disadvantages of the traditional home except for the inability of the house to have new floors added.</li> <li>○ Users prefer to live in traditional housing with a courtyard.</li> </ul> <p>Users understand the environmental role of the courtyard after they moved into contemporary housing.</p>	

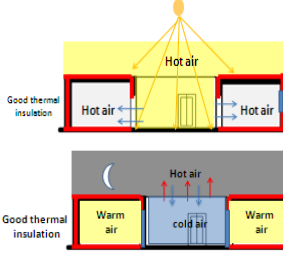
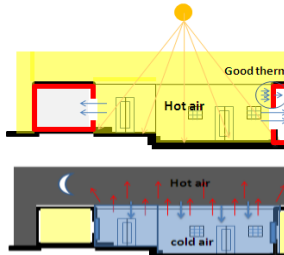
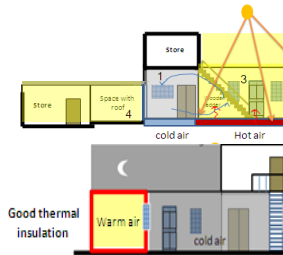
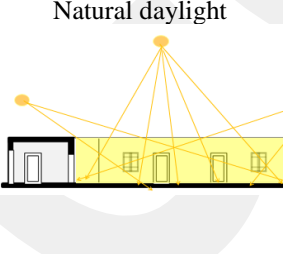
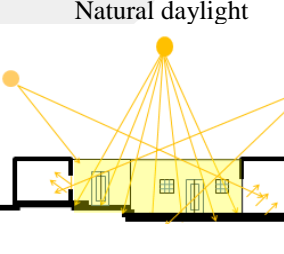
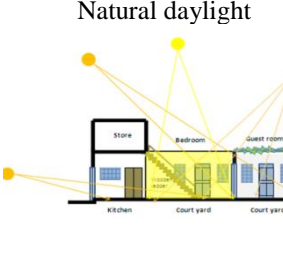
### 3.2.4. Conclusion for case study housing

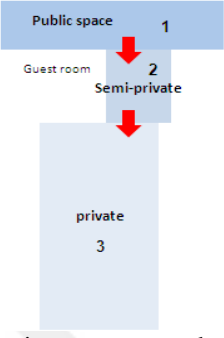
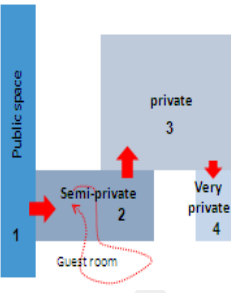
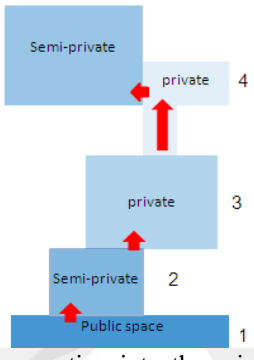
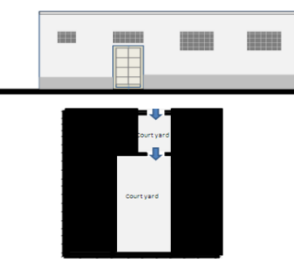
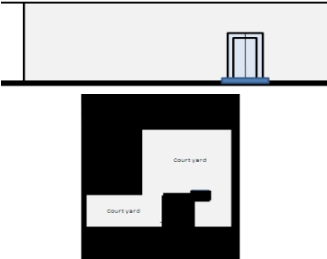
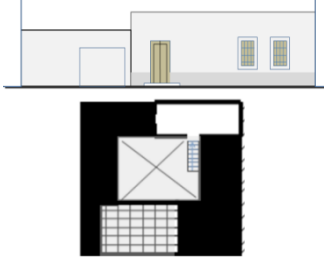
In this study, houses were analyzed for people who lived in traditional houses and then moved to contemporary houses. (They had the experience of living in both traditional and contemporary housing.) Through analysis of the traditional houses, many important points were concluded in the system of lighting, ventilation, cooling and heating and other factors. The traditional houses were also compared with contemporary houses to identify the reasons for users selecting their answers. Finally, here in this section, the results are summarized as follows:

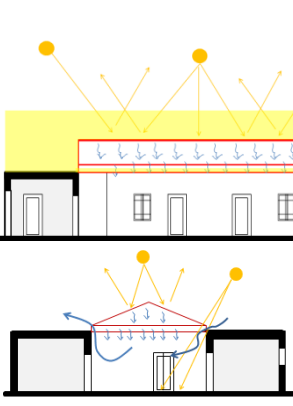
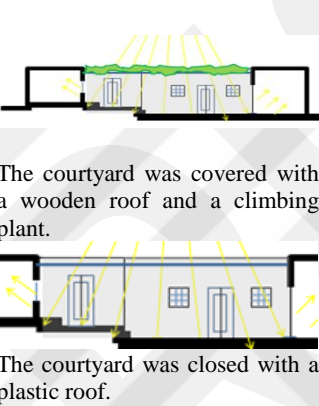
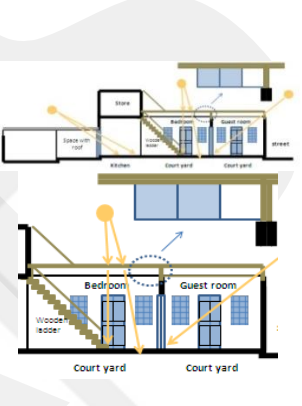
- Traditional courtyard housing succeeded in creating a suitable environment in terms of natural lighting, ventilation, cooling and heating.
- The owners of traditional courtyard housing liked their houses, especially the environmental solutions which were provided to them. (They knew the importance of the traditional courtyard house after they moved to contemporary houses.)
- The only obstacle to living in the traditional home was the inability of the structure to have new floors added.
- The privacy which the traditional courtyard house provide to women is good; however, there is no privacy between family members (doors to every room opened out directly to each other).
- Safety is available in the traditional house if it has two floors.
- As a final conclusion, there are many successful environmental solutions that must be considered when designing low or nearly zero energy houses in the future.

**Table 3.12: Analysis and Results**

	Case Study House one (CSH.1)	Case Study House two(CSH.2)	Case Study House three(CSH.3)
Structure and materials			
Analysis	<p>The structure consists of walls, the floor and a roof. The walls have thickness and dimensions according to climate and position. Every walls built from limestone blocks with mortar made from sand and lime. The roof is built with strong beams, stones and mortar.</p>	<p>The system depends on connected walls without columns, known as load-bearing walls. The external wall thickness ranges between 40 cm and 60 cm. Roof height is about 3 m. The roof consists of timber, sandstone and limestone. Most of the timber comes from palm trees.</p>	<p>The structure consists of load-bearing walls and a roof made from timber, sandstone and limestone. However the out store was built from timber wall and timber roof.</p>
Ventilation and cooling			
Analysis	<p>The shady and light places allow air to move. The air also moves from the small court to the large court.</p>	<p>The shady and light places allow air to move. The thickness of the walls and their materials help to insulate the building from high temperatures.</p>	<p>There are two court yards which help to create air movement between the shady and sunny places.</p>

Users opinion	<p>Users stated that contemporary housing was better than traditional housing in terms of ventilation and cooling systems. The reason for this answer was because the stairhall helped to provide good ventilation in the north façade.</p>	<p>Users stated that traditional housing was better than contemporary housing in terms of ventilation and cooling systems. The reason for this answer was that the rooms were cool in the summer because of the wooden materials that were used for the roof and the thickness of walls, which has good insulation.</p>	<p>Users stated that traditional housing was better than contemporary housing in terms of ventilation and cooling systems. The reason for this answer was that the courtyard and its local materials helped to create a good system.</p>
Heating			
Analysis	<p>Using local materials that had thermal mass, users would open windows in daylight hours for hot air to enter the rooms.</p>	<p>In the afternoon, hot air gathered in the yard, so the doors and windows of the rooms were opened to allow hot air to move inside. Users would close the windows and doors at night to keep in the hot air.</p>	<p>The thickness of the walls helped to keep the rooms warm, especially when the windows were opened.</p>
Users	<p>Users stated that the rooms were warm in the winter and that the traditional house was better than the contemporary house.</p>	<p>Users stated that traditional housing was better than contemporary housing in terms of heating systems.</p>	<p>Heating systems in traditional housing were better than in contemporary housing.</p>
Lighting	<p>Natural daylight</p> 	<p>Natural daylight</p> 	<p>Natural daylight</p> 
Analysis	<p>The interior courtyard provides natural daylight during day hours. This light comes through the windows and doors into the indoor spaces.</p>	<p>Natural light and sunshine comes through the courtyard into the room spaces via tall windows and doors.</p>	<p>The central courtyard allows sunlight to enter the rooms, especially in the southern façades. Every room has good day lighting which comes through the windows and doors, as attested by users.</p>

Users' opinion	Initially, the lighting was good, but after changing the floor materials, it became light reflective. Users covered the space as a result and for other reasons.	Preference for natural lighting, especially when the floor is not reflective of sunlight.	Users are satisfied with the lighting.
Privacy	 <p>Despite being incorporated into the privacy of the space, the main entrance does not provide privacy to the main spaces.</p>	 <p>Incorporation into the privacy of the space, there is good privacy in the spaces, as stated by users.</p>	 <p>Incorporation into the privacy of the space.</p>
Analysis	There is a semi-private courtyard that offers privacy to the guest; i.e., there is a men's room that has high windows facing the main street.	An indirect connection between the small and large courtyards provides privacy for all family rooms, and there are no windows open to the street.	The privacy of the old society helped to create a special space for women to live away from strangers. For instance, there were two courtyards; the first connected to the main entrance with a guest room, while the central space is used for social interactions all family members.
Users' opinion	Users do not prefer the privacy of this housing. Reason for answer: Privacy of rooms is not good.	Users prefer the privacy of this housing. Reason for answer: They like to sit in the courtyard due to its provision of privacy to women.	Users prefer traditional home privacy more than contemporary home privacy.
Security			

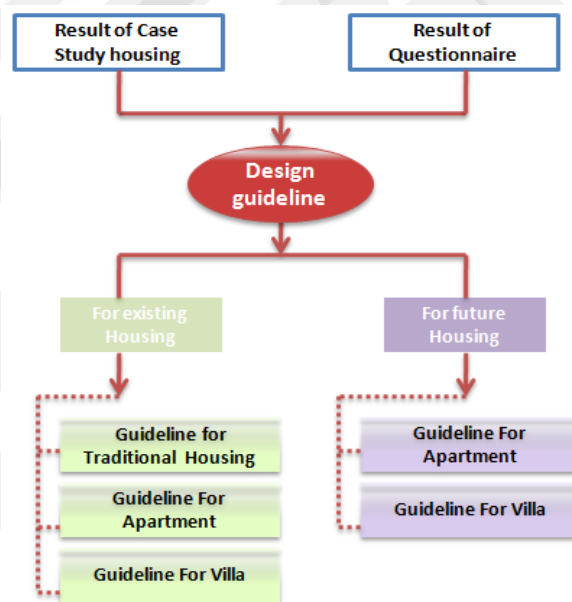
Analysis	The structure of the building and the lack of openness to the outside provided security to an acceptable degree	The building design reflected people's need for provision of safety and privacy in a simple manner.	The house has the same characteristics of the traditional local house such that, with exception of the guest space, there is openness towards the internal spaces. As a consequence, this made the house very safe by reducing the openness to the outside.
Users	After closing, the courtyard becomes safe; however, the contemporary house was not safe.	Users' opinion that the contemporary house was safer than the traditional house.	Contemporary housing is safe and after closing the courtyard of the traditional house, it became safe.
Modifications	 <p>The courtyard was covered with a wooden roof and a climbing plant.</p> <p>The courtyard was closed with a plastic roof.</p>	 <p>The courtyard was closed with a transparent roof.</p>	
Analysis	The courtyard was covered by wooden beams with aluminum panels. The owner expanded the size of the kitchen space.	The courtyard was closed with a transparent roof.	These needs are the owner closing the middle courtyard partly with wooden materials which are resistant to the climatic conditions.
Users opinion	Why did users close the court yard? (1) Because of the rain,(2) to provide privacy from neighbors' view from high buildings, and (3) because the floor reflected light.	Why did users close the court yard? For protection from the rain in the winter	Why did users close the court yard? Their unwillingness to expose their spaces to the rain and dust, as stated by users.

<b>Results</b>	<ul style="list-style-type: none"> <li>○ According to users' answers:</li> <li>○ Traditional housing has good lighting and heating systems.</li> <li>○ Contemporary housing has good ventilation and cooling</li> <li>○ Ventilation is excellent. The rooms are cooler all summer in contemporary houses than in traditional houses. However, in the winter, contemporary houses were very cold. Users preferred contemporary houses to living in traditional housing. Users do not prefer housing with courtyards, while they preferred houses with an out door balcony because the yard brings dust.</li> </ul>	<ul style="list-style-type: none"> <li>○ According to users' answers:</li> <li>○ The housing had a high level of lighting, ventilation, cooling and heating.</li> <li>○ Building materials helped to cool the rooms in the summer and heated them in the winter.</li> <li>○ There was good privacy for women, who could be away from strangers. Wall thickness provided good insulation.</li> <li>○ The rooms are ventilated away from the smells of the kitchen. The contemporary house has bad ventilation and is considered to be a dark space, as stated by users.</li> <li>○ Users prefer to live in traditional housing rather than contemporary housing.</li> <li>○ The only reason to demolish a building was due to the inability of a traditional building to be expanded vertically.</li> </ul>	<p>According to users' answers:</p> <ul style="list-style-type: none"> <li>○ Traditional housing is better than contemporary housing in terms of lighting, ventilation, cooling and heating systems.</li> <li>○ The reason for a good indoor environment as one user stated was the building materials and the courtyard.</li> <li>○ The traditional home is better than the contemporary house in terms of privacy.</li> <li>○ There were no disadvantages to the traditional home except for the inability of the house to have new floors added.</li> <li>○ Users prefer to live in traditional housing with courtyards.</li> <li>○ A user understood the environmental role of the courtyard after he moved into a modern house.</li> </ul>
<b>Final results</b>	<p><u>Final results</u></p> <ol style="list-style-type: none"> <li>i. Traditional housing succeeded in creating a suitable environment in terms of lighting, ventilation, cooling and heating.</li> <li>ii. The owner of TH liked their housing, especially the environmental solutions which were provided in the traditional home. (They knew the importance of the traditional house after they moved to contemporary houses.)</li> <li>iii. The only obstacle to living in the traditional home was the inability of the structure to have new floors added.</li> <li>iv. The privacy which traditional houses provide to women is good; however, there are no privacy between family members (the doors to every room open out to each other).</li> <li>v. Safety is available in the traditional house if it has two floors.</li> </ol> <p>The traditional house was better if it consisted of two floors, such as the houses in Tripoli in the west. There are many successful environmental solutions that must be considered when designing low or nearly zero energy houses in future.</p> <p><u>Note:</u>  People who used to live in a traditional house then moved to a modern house preferred the traditional house more than the modern house.  People used the air conditioning in traditional housing just in summer time in (When the desert winds came )</p>		

## CHAPTER IV

### DESIGN GUIDELINE

The solutions in this study were divided into two main parts: solutions for existing housing and solutions for new housing, which is the essential part of this study. Thus, the solutions depend on the results coming from the questionnaire analysis and the six houses analysis (a case study of traditional and contemporary houses in Derna city). All these solutions will achieve the research aim to solve the environmental issue of housing, as illustrated in the following figure 4.1 .

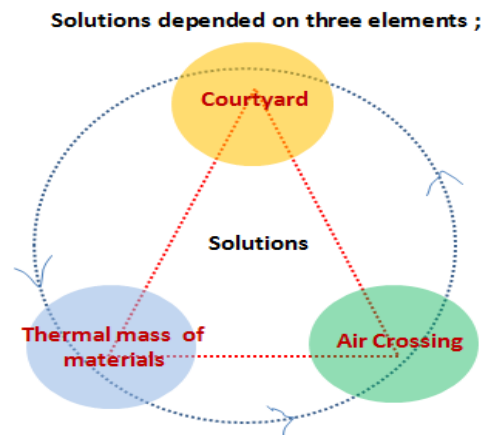


**Figure 4.1:** Suggested solution types

#### 4.1. Structure of the Solutions

The proposed solutions and examples are based on three important strategies: (1) the role of courtyard in providing natural ventilation, cooling, heating and lighting; (2) the role of traditional thermal mass materials in Derna city to provide cooling and heating for indoor spaces; and (3) creating an air circulation system (creating a

path for cold air to move from a cold zone to a warm zone) to cool indoor spaces during the summer, as shown in Figure 4.2.



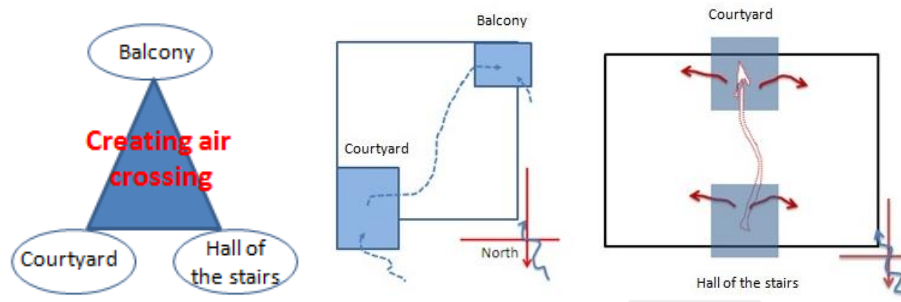
**Figure 4.2:** Structure of suggested solutions

**4.1.1. Role of the courtyard;** The role of the courtyard differs according to the time of day and seasons. For instance, in the summer time at night, the courtyard works as a store for cold air; therefore, users open the windows to allow cold air to enter (different pressure areas allow air to move from cold zones to warm zones). However, during daylight hours, users also close windows in order to keep in the cold air. Additionally, during the winter, especially at noon, hot air gathers in the courtyard; therefore, the doors and windows of rooms were opened to allow hot air to enter and at night, users close the windows and doors at night to keep in the hot air.

**4.1.2. Traditional thermal mass materials;** the traditional materials that were used in housing had the benefit of a cooling and heating system. All traditional housing in Derna city is made from local materials, as illustrated in Chapter Three. In the case study housing, all users' answers were preferred with traditional homes rather than contemporary houses as the former were cool in the summer and warm in the winter due to good insulation, the thickness of walls (thermal mass) and the properties of local materials, as answered by the local people.

**4.1.3. Air flows in the building;** this idea depends on air movement from a cold zone (high pressure) to a warm zone (low pressure). This type of solution in the figure (Figure 4.3) allows cold air to flow from the courtyard to the balcony or from

the hall of the stairs to the courtyard; hence, the idea based upon the findings of the case study houses in the last chapter.

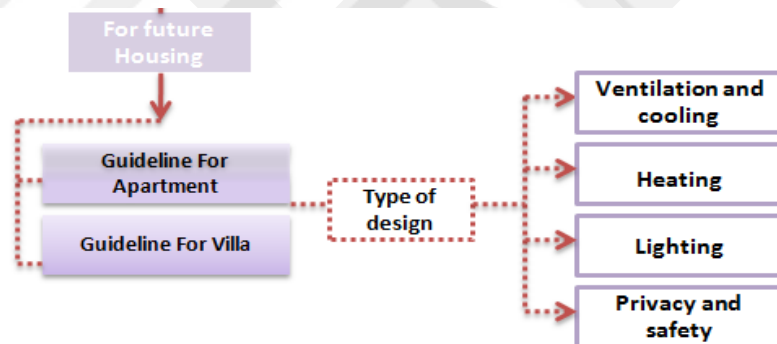


**Figure 4.3:** Air crossing in the building; in this example, the cold air moves from the north zone to the south zone, or from the northwest zone to the southeast zone.

## 4.2. Design model ;

### 4.2.1. Design model for future contemporary housing

A number of suggested solutions for natural ventilation, cooling, heating and lighting are considered as future solutions for Libyan housing, as shown here:



**Figure 4.4:** Suggested Solutions for villas and apartments

#### 4.2.1.1. Design model for Detached house

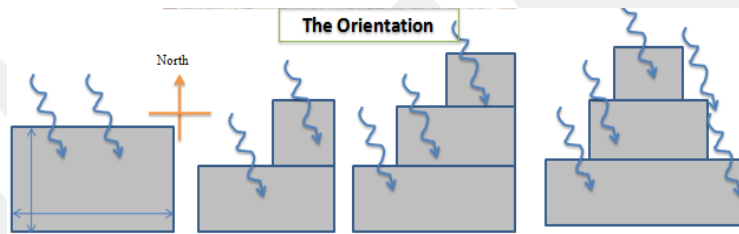
##### a. Ventilation and cooling (in the summer)

The climate of Derna city is hot and humid in the summer and very cold and rainy during the winter. Therefore, a good orientation for buildings is the northwest side as the wind constantly comes from this direction all year.



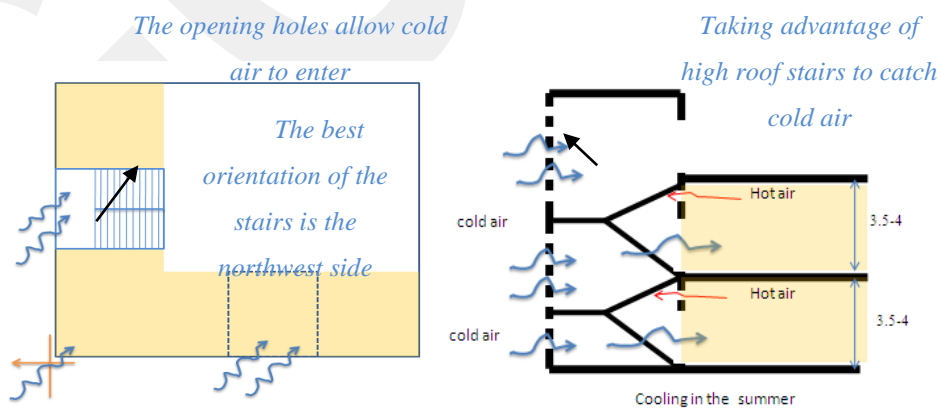
**Figure 4.5:** Wind direction in the city of Derna, (Google Earth)

The climate is arid and semi-arid with temperatures ranging between 13 °C in January and 25 °C in August and relatively high humidity (between 73.3% in the winter and 61.6% in the summer) due to proximity To the Sea. (E I Osta, 2016)

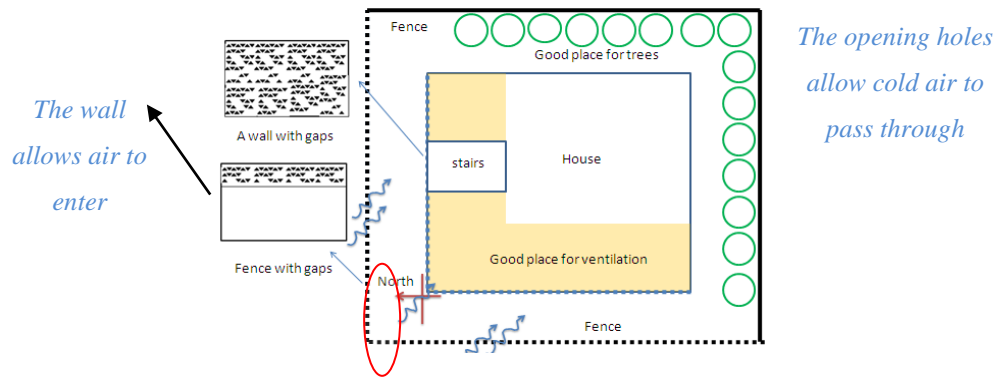


**Figure 4.6; Ventilation and cooling;** It is preferable that the building be facing the northwest wind without obstacles as it illustrates here

**a.1.Ventilation and cooling by the stairs ;**We can take advantage of the stairs to cool the interior spaces of the house. The openings on the wall of the stair face the cold air, which comes from the north and northwest, which allows cold air to enter the stairs and then pass to the indoor spaces, as illustrated in Figure 4.7.



**Figure 4.7:** Wind direction and using the hall of the stairs to cool the indoor space



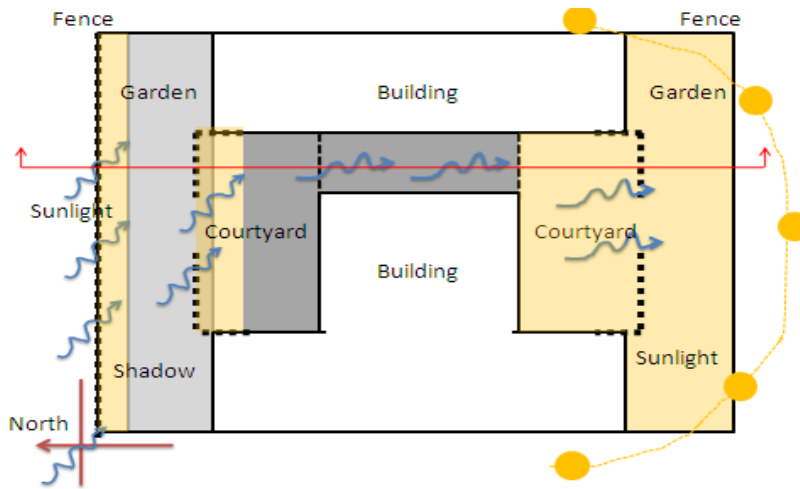
**Figure 4.8:** Ventilation and cooling by the stairs; the good places for ventilation and cooling and the shape of the walls allow cool air to cool the interior spaces of the house.

**Table 4.1:** Lessons learned from Case Study Housing 1

Case study housing	The solution
<p>The solution comes from Case Study Housing 1.</p>	<p>The best location for the stairs hall</p>
<p>The solution comes from Case Study Housing 1.</p>	<p>The small gaps help cool air to enter.</p>
<p>The solution comes from Case Study Housing 1.</p>	<p>Less barriers and more gaps to allow cold air to enter in the summer</p>

**a.2. Ventilation and cooling by the courtyard:** In Figure 4.9, the idea of the proposed solution here depends on creating two courtyards, one of which is shaded and the other sunny, in order to help the cold air flow from the cold zone (high-pressure areas) to the hot zone (low-pressure areas). Moreover, the court has walls

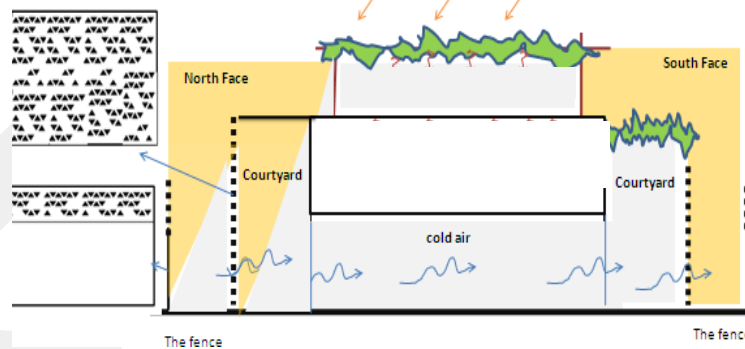
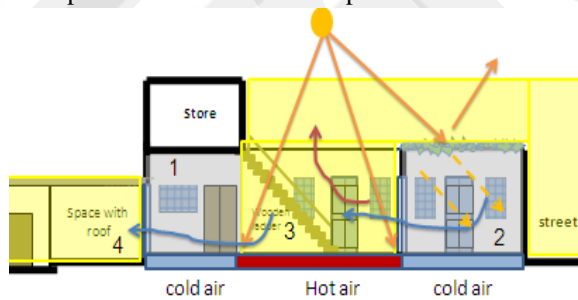
with gaps or openings that make the air move from the outside to the inside without affecting privacy.



**Figure 4.9:** Ventilation and cooling by the courtyard; using two yards, one is shaded and the other sunny. Thus, different areas of pressure will help the cold air to move from the high- pressure areas to the low- pressure areas.

*Solution comes from case study*

1



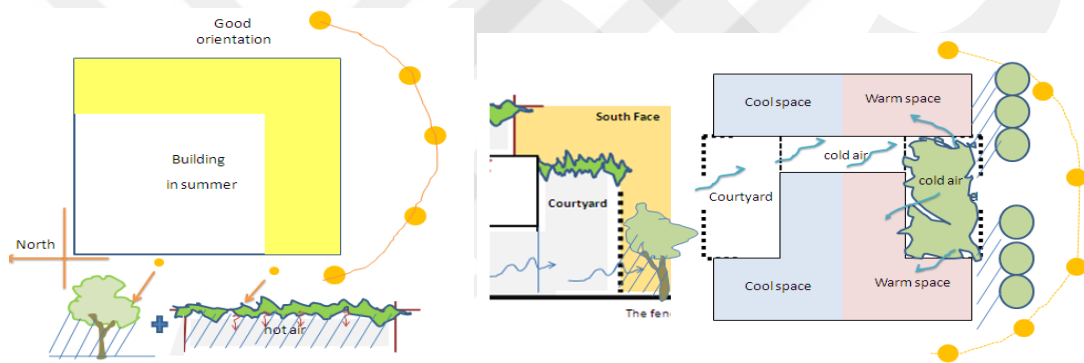
**Figure 4.10:** Ventilation and cooling by courtyard 2; covered wall allowing for shade and privacy. The green surface reduces solar heat and gives shade by dispersing light and radiation as well as absorbing solar radiation.

In Figure 4.10, hot air rises to the top and is replaced by cold air. The southern courtyard in the summer is exposed to the heat of the sun, so people resort to dividing it with plants above the surface in order to create shade and reduce the heat of the sun in the summer.

**b. Lighting solutions in the summer**

The southern façade is exposed to the heat of the sun, in which case the proposed solutions of the balcony window and plants reduce the heat of the sun in the summer, thus:

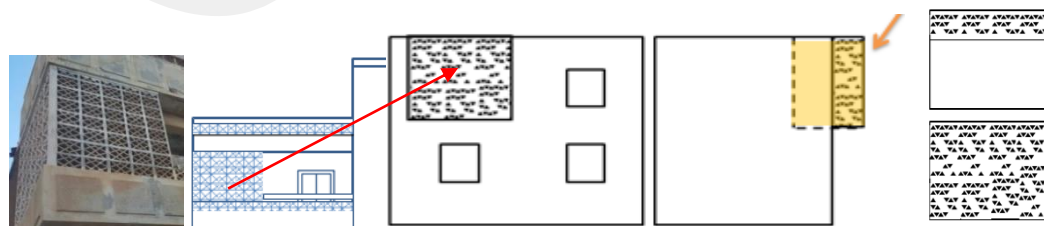
**b.1. plant ( Figure 4.11 ):** Plants in the southern façade help to provide shade and reduce heat gains in the summer. In addition, the north yard as a high pressure zone helps the cold air to move to the south yard as a low pressure zone.



**Figure 4.11:** Lighting solutions in the summer Vegetation provides pleasant air The courtyard helps to reduce the heat of sun with plants

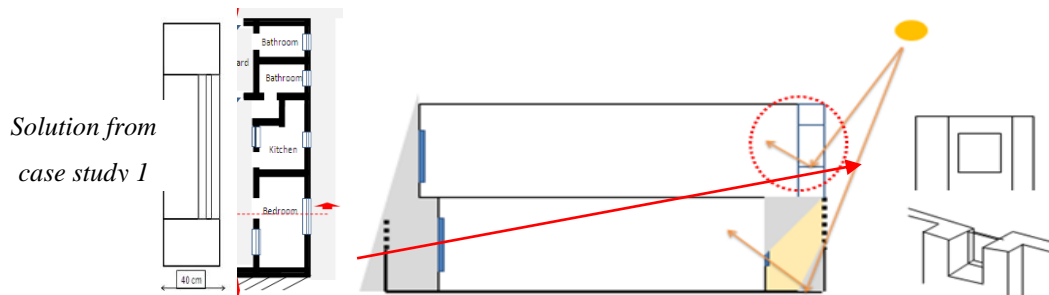
**b.2. Balcony (Figure 4.12):** The solution of covered balconies reduces the heat gain as well as provides a private space for women to sit and interact with family members without being seen by neighbors.

*Solution from case study 1*



**Figure 4.12:** Example of a covered balcony with gaps; these gaps (the small openings) allow air circulation.

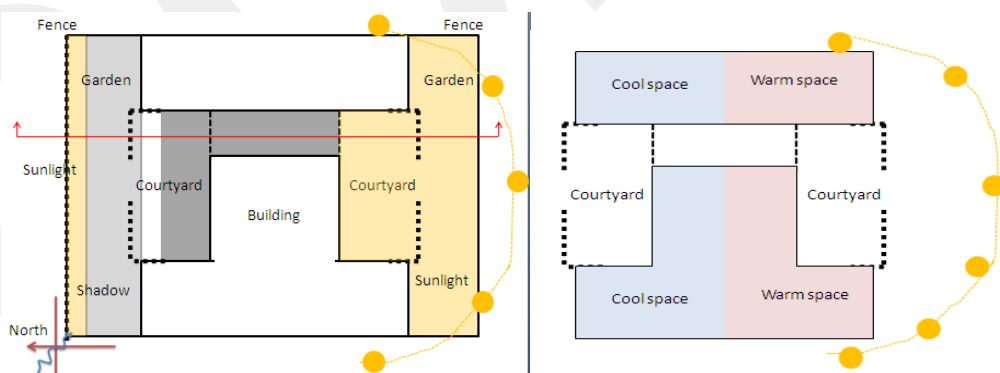
**b.3. South window (Figure 4.13):** The southern façades receive the direct heat of the sun in the summer time. The proposed solution of depth of windows will prevent direct sunlight from entering. This will also control the amount of light with the small gaps in the wooden windows. Wooden windows also reduce heat gain, especially on hot days.



**Figure 4.13:** Example of lighting by windows; the thickness of the wall prevents direct sunlight from entering. In addition, the prominence of the first floor produces suitable shade.

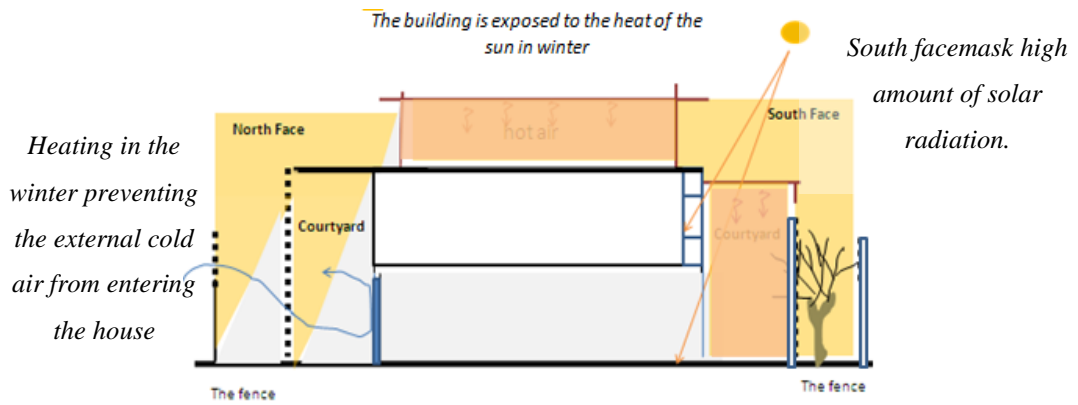
**c. Heating and lighting solutions in the winter**

For the summer, a proposed solution depends on cold air that comes from north, which helps to cool the northern courtyard while in the winter. It depends on the southern courtyard that offers direct heat of the sun to warm the courtyard. The benefit of heat from the sun comes from exposing the space of the courtyard direct to the sun without obstacles. This works as a heat store and benefits can be received by opening windows during the day and closing them at night.



**Figure 4.14:** Heating and lighting solutions; the building is exposed to solar heat in the winter.

The central courtyard allows the heat of the sun to enter the rooms, especially at the southern façades. Every room has good day lighting, which comes through the windows and doors.

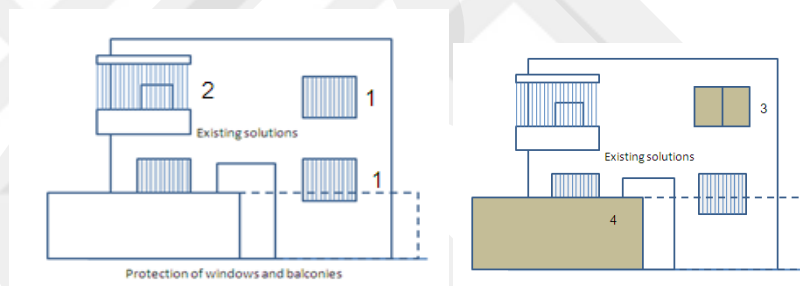


**Figure 4.1.** Heating in the winter; preventing external cold air from entering the house.

**d. Privacy and safety**

The existing case of balcony;

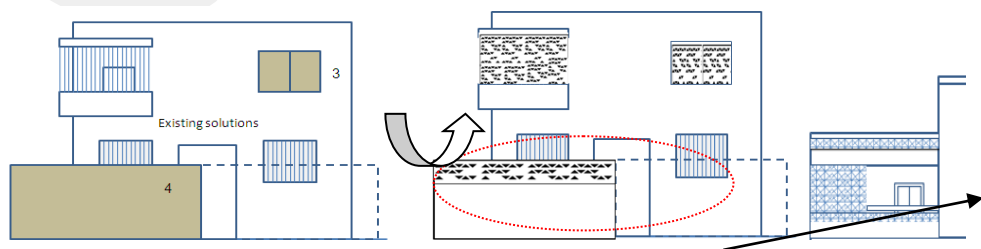
- 1- Users protection of the balcony (2) so as to provide safety
- 2- Users close their windows (1) to achieve privacy.
- 3- Users use a high fence (4) to achieve privacy



**Figure 4.16:** Types of existing solutions

Solution of the façade: In this section, some suggested solutions, such as a high fence, covering the balcony and courtyard are explained here.

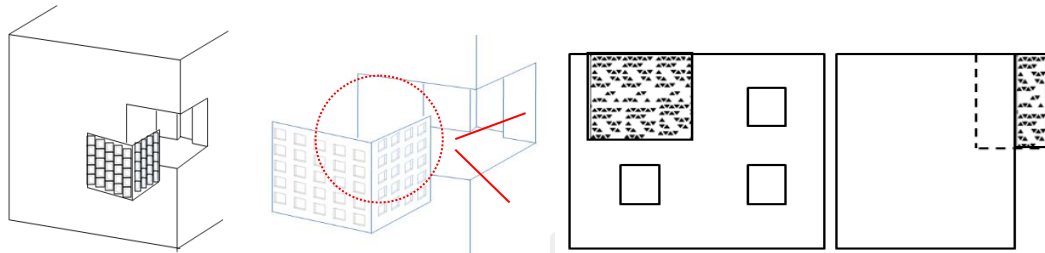
**d.1. High fence with high gaps ;**Small gaps in the fence allow cold air to enter and replace the hot air as well as provide privacy.



**Figure 4.17:** High fence

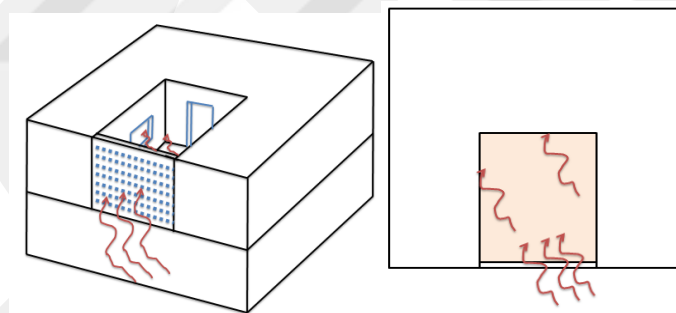
**d.2. Covering the balcony with the wall:** This form allows users to use this area in daily life because it provides high levels of privacy, more so than the existing one.

In Figure 17, the covering balcony in the corners of the buildings provides good ventilation of the northwest facade and high levels of privacy with a view.

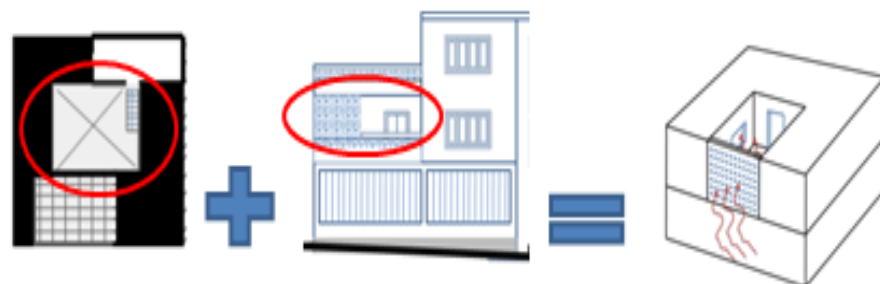


**Figure 4.18:** Example of a covering wall that provides privacy

**d.3. Courtyard:** Here, we integrate the function of the balcony with the function of the courtyard to provide a social space with a high level of privacy, as shown in the figure below.



**Figure 4.19:** Example of a courtyard



**Figure 4.20:** Solution for courtyards; the idea comes from combining the balcony with the courtyard in the same form to create a social space with high privacy

#### 4.2.1.2. Design model for Apartments

An apartment as a second kind of contemporary housing is divided into low-rise apartments and high-rise apartments. Some environmental solutions for contemporary housing are presented here in two ways:

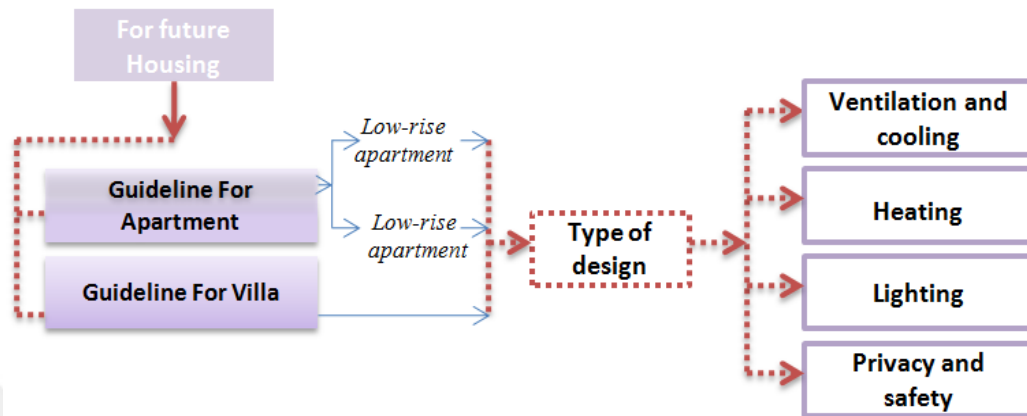


Figure 4.21: Solutions for apartments

##### a. Low-Rise Apartments

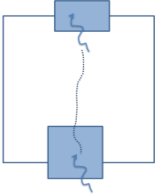
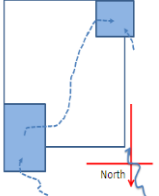
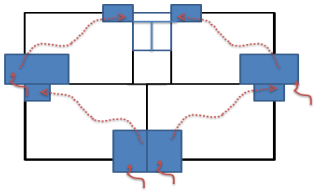
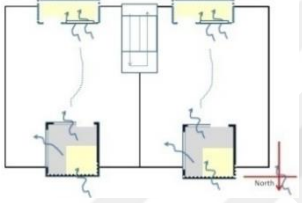
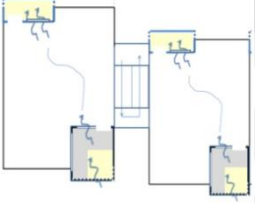
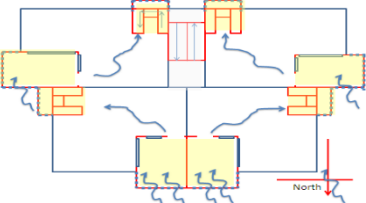
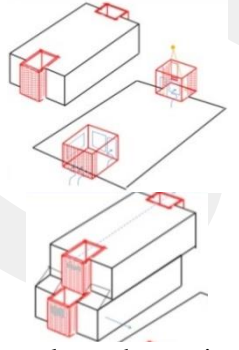
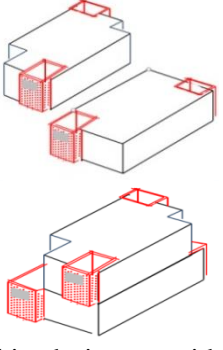
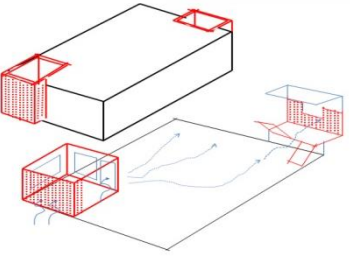
This kind of housing consists of two or three floors. Each floor contains two or four apartments. The common characteristics of this type is the existence of a service yard that is used for ventilation and lighting, only without any social purpose.



Figure 4.22: Low-rise apartments in Libya ( Courtyard in case study area )

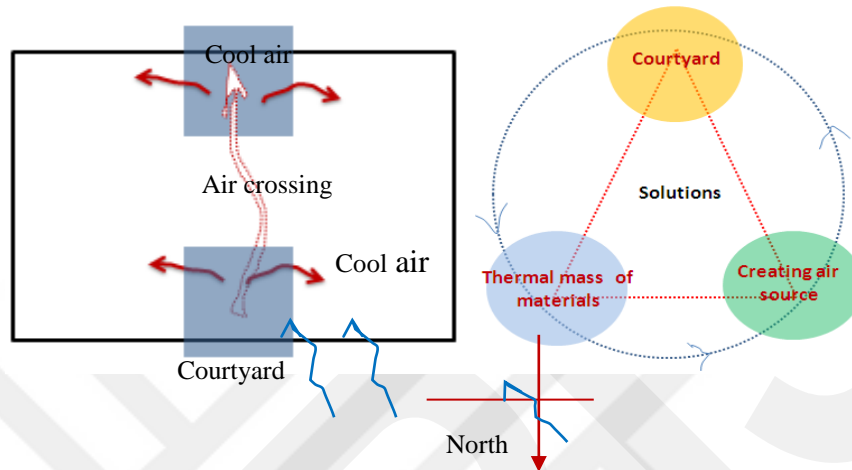
**a.1. Examples of solutions :**The solution is to create a way for air to flow across the building between two external spaces with the aim of ventilating and cooling the indoor spaces during the summer.

**Table 4.2:** Guidelines for low-rise apartments

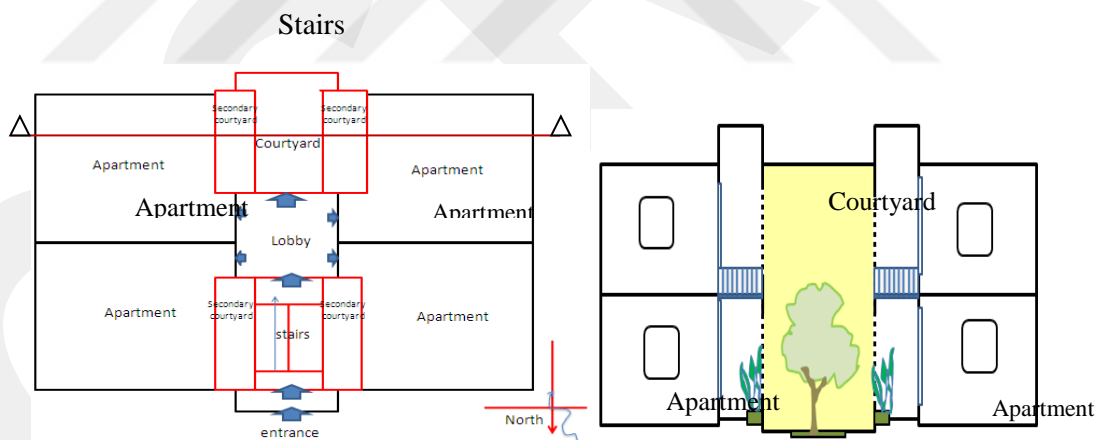
Low-rise apartments			
	Proposal 1 Two Apartments on two floors	Proposal 2 Two apartments on two floors	Proposal 3 Four apartments on two floors
Idea	 <p>The idea in this example depends on creating a vertical path for cool air to move between the interior spaces of the apartment.</p>	 <p>The idea in this example is to create a path for the air with a slanted axis between the courtyard and the balcony.</p>	 <p>The idea in this example is to create air movement between the court yard and the hall of the stairs.</p>
Design	 <p>Each floor consists of two apartments and between them, a hall for the stairs. The courtyard is located in the north, which makes it a good space for the summer time.</p>	 <p>This design allows air to enter better than in the previous example. To achieve this result, the yard faces the northwest and receives the greatest amount of cold air in the summer.</p>	 <p>Each apartment has two floors and their own stairs and courtyards. The court stands out from the northern facade to receive the greatest amount of cool air in the summer.</p>
The form	 <p>To solve the privacy problem, each apartment has its own courtyard and balcony without being able to be viewed by the neighbors, as shown in the diagram.</p>	 <p>This design provides a high level of privacy because the yards are not closed on different floors.</p>	 <p>This figure shows one apartment with a southern staircase.</p>

From this table, one of these examples is analyzed here:

**a.2. Solution for Proposal 3:** The solutions depend on first designing a courtyard, second on creating a way for air to flow across the building, and third the use of local materials. As shown in the diagram below, the example consists of two floors, each floor has four apartments, and the hall of stairs faces the north while the courtyard faces the south.

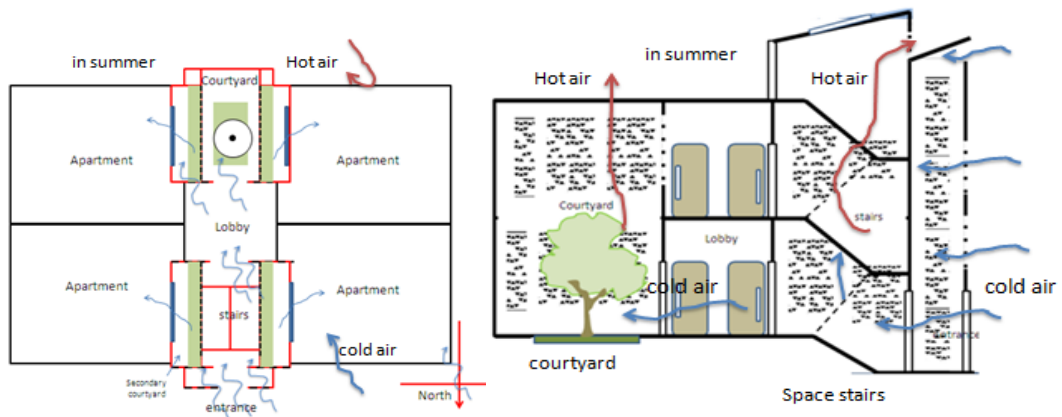


**Figure 4.23:** Solution idea: The idea of the design depends on making the air move from one open space to another without obstacles so as to provide natural ventilation and natural cooling to indoor spaces.



**Figure 4.24:** Plan of the design solution –section in the courtyard .The building was analyzed according to ventilation, cooling, heating, lighting, privacy and safety, as shown here.

- **Cooling solutions (in the summer):** First, the cold air enters through the northern façade to the space of the stairs and replaces the hot air which goes to the top. Second, the cold air moves into the yard and enters the apartment rooms through the wall openings as illustrated in the figures below. The northern apartments will receive the largest amount of cold air in the summer; the southern apartments will receive the cool air from the southern courtyard.

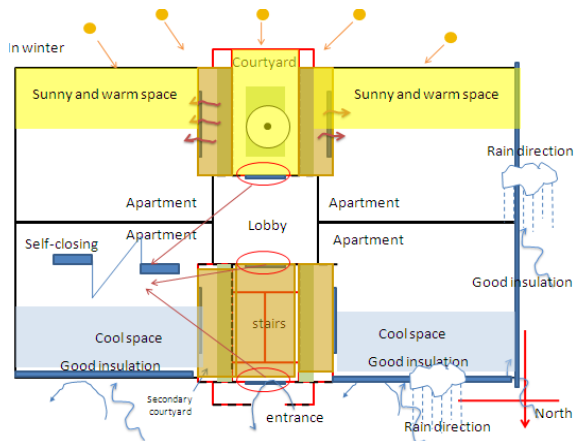


**Figure 4.25:** Form of ventilation and cooling in plan and section

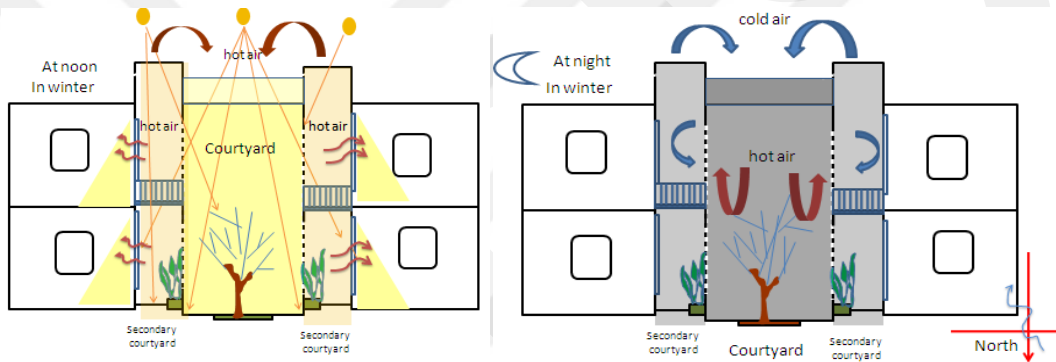


**Figure 4.26:** Cooling Solutions; the cold air enters the interior space through gaps on walls then the glass windows, which located behind the walls

- Heating Solutions (in the winter):** The southern courtyard receives the highest solar radiation in the winter. In the daytime, the courtyard keeps in the warm air and warms the surrounding space, if the windows are open, as illustrated in the figures below. At night, the thermal mass of local materials will help to warm the space of the southern apartments (from the roof and walls) and of the northern apartments (from the roof). However, the northern apartments are on the ground floor and the cold northern air and rain will be the greatest winter problem for the northern face. Local materials and good insulation of windows and doors will solve this problem.

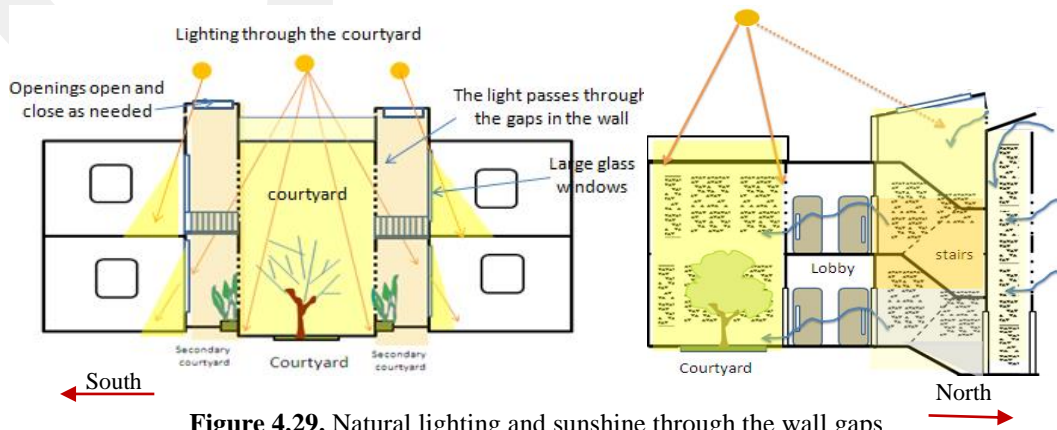


**Figure 4.27:** Heating Solutions 1; the illustration shows the proposed places of isolation in the winter, which are northwest facing. Good insulation is achieved using local materials and increasing wall thickness. All users confirmed that traditional homes were warmer than modern homes due to the good insulation and thickness of walls.



**Figure 4.28:** Heating Solutions 2; in order to achieve heating of the rooms, the windows are open during the day and closed at night.

- Lighting:** The open courtyard formed with the hall of the stairs helps to provide good natural lighting for every space in the building, as presented in Figure 4.29. The rooms receive natural lighting in the summer and winter without affecting the privacy required by users.



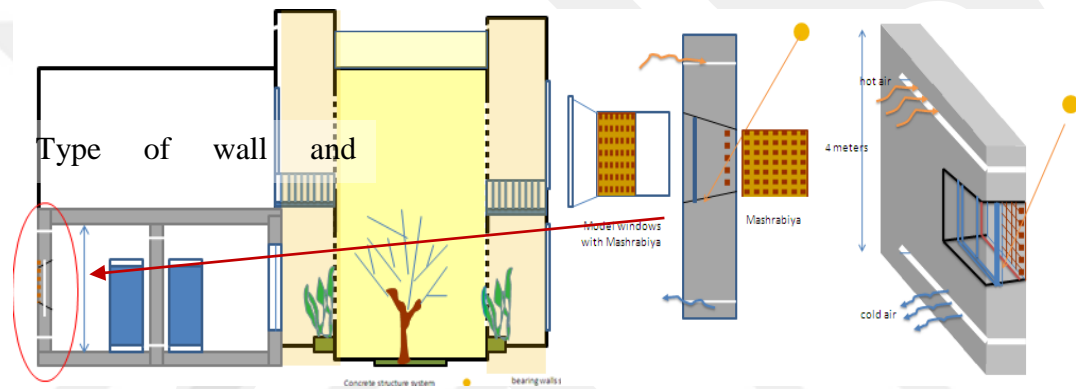
**Figure 4.29.** Natural lighting and sunshine through the wall gaps

- **Materials:** Using local materials helps to cool the indoor space in the summer and heat it in the winter according to the theory of thermal mass of local materials. The figure below explains this and how it makes air flow from place to place.

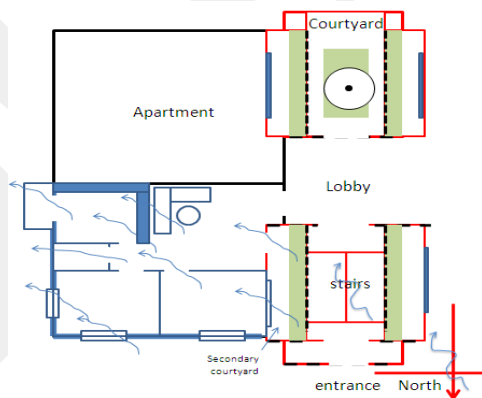
**-Walls:** The walls should have a lower opening that allows cold air to enter while a higher opening allows the hot air to exit.

**-Windows:** The windows consist of a wooden with small gaps that allow light and air to enter.

**-Doors:** The gaps under the doors allow air to pass from one place to another.



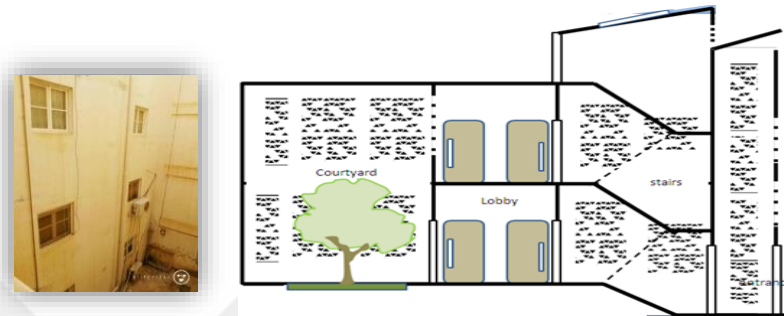
**Figure 4.30:** Solution of ventilation and lighting; this figure presents the form of the wall and the type of window to provide natural ventilation and lighting without affecting privacy.



**Figure 4.31:** Solution of ventilating indoor spaces: An example that illustrates the manner of ventilation of indoor spaces through the central courtyard during the summer

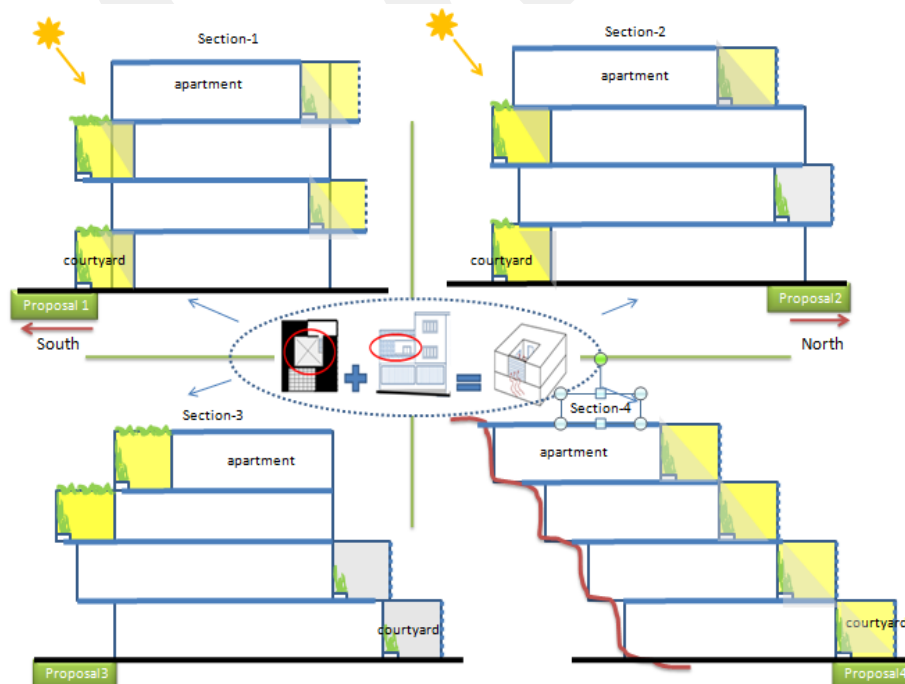
The cool air coming from north face enters the hall of the stairs and then goes through the gaps of the wall to the indoor space through the glass windows. The figure presents the path of the air crossing inside the rooms. The doors and gaps of the walls help the building to breathe in the summer.

- Privacy and safety** :The dead spaces in Libyan housing are the balcony and courtyard because they are not used in social life; (they are exposed to neighbors or strangers). The proposed solution for courtyard facades illustrates type of wall with gaps which allows sunlight and natural ventilation to enter and prevent direct viewing. In addition, this solution provides a high degree of security to users.



**Figure 4.32:** A public courtyard on the ground floor and courtyard facades providing high levels of privacy to users

**Example of apartments with private open space** ;There are many solutions for designs of apartments with their own courtyards instead of common a courtyard between a numbers of apartments. This type of solution provides social privacy to users as well as the environmental benefits of lighting, ventilation, cooling and heating. Balconies can be added to create a path for cold airflow across building.



**Figure 4.33:** Example of apartments with private courtyards

In the following figure, the south courtyard provides lighting, heating and privacy, while the north courtyard provides natural ventilation and cooling in the summer. Some simple solutions are used here, including the use of plants to reduce dust and solar radiation in the summer, and gaps in the walls of the northern façade to cool the indoor spaces.

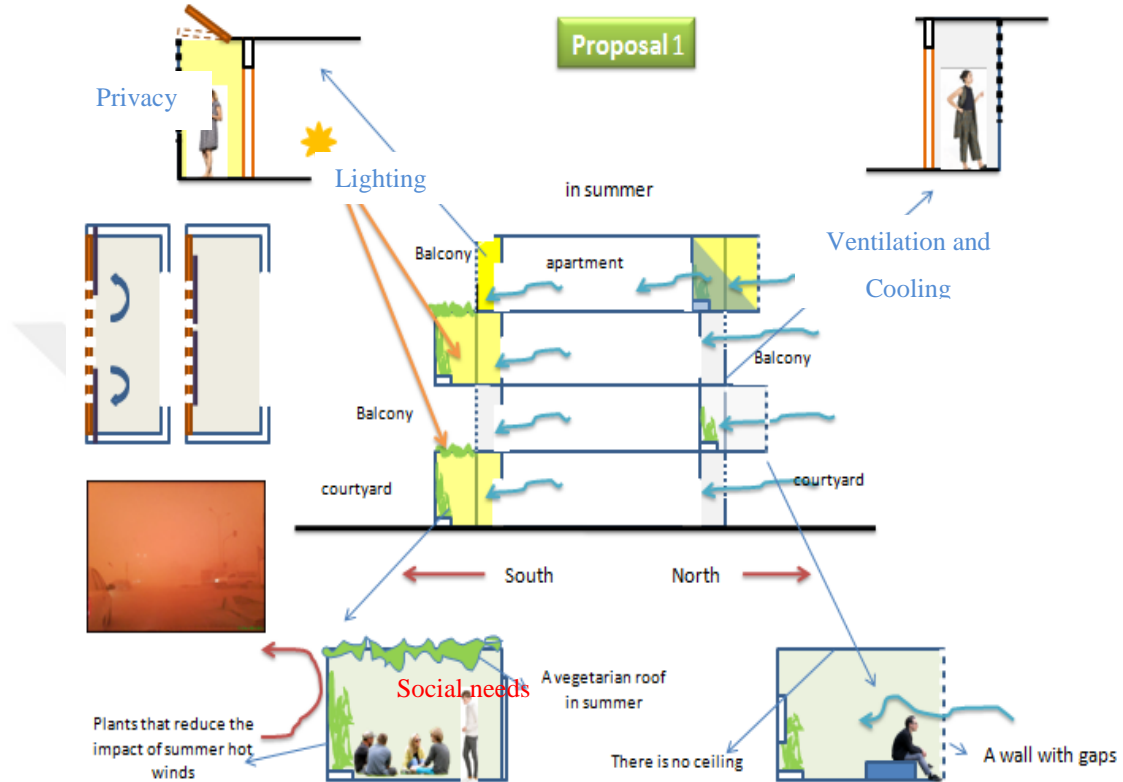


Figure 4.34: Solution for courtyards and balcony

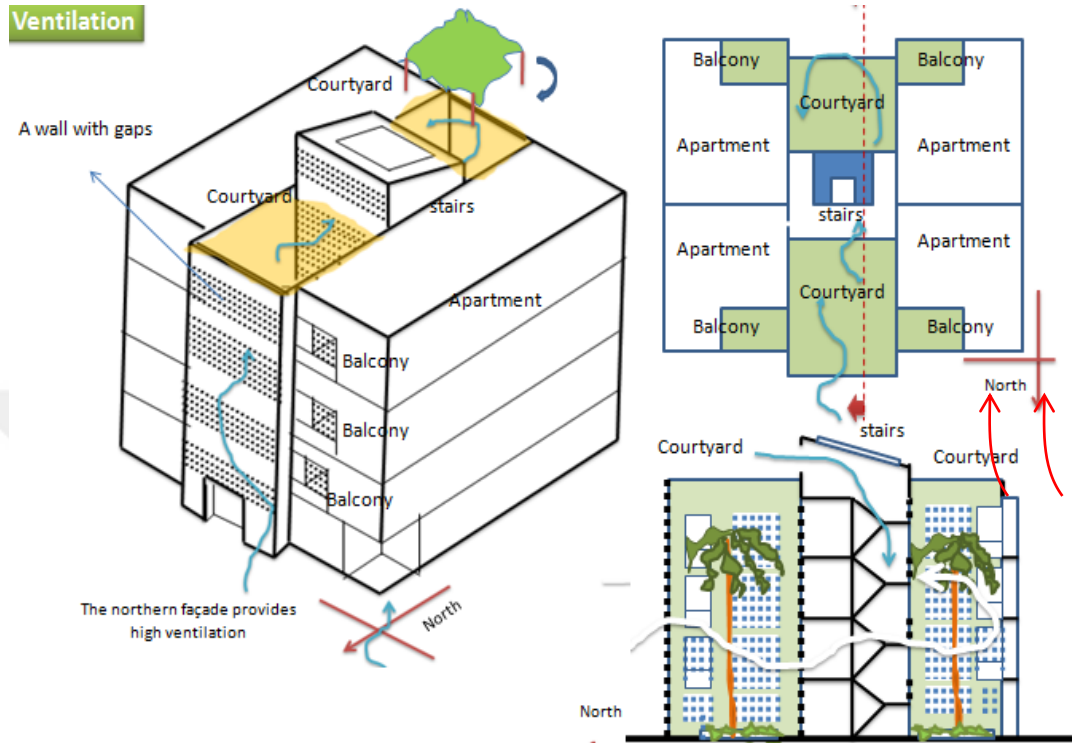
## b. High-rise apartments

The four proposed examples have been analyzed in terms of ventilation, cooling, heating, lighting, privacy and safety:

### b.1. Example I

As illustrated below, the building consists of four floors, but possibly up to six floors, each floor having four apartments with two courtyards. The best building orientation is to the north so as to receive the best cooling and ventilation in the summer.

- Ventilation and cooling:** The four suggested solutions aim to make the cool air enter the indoor space without obstruction in the northern facades, such as the courtyards, roof of the stairs, the balconies and wooden windows, which are explained as follows:



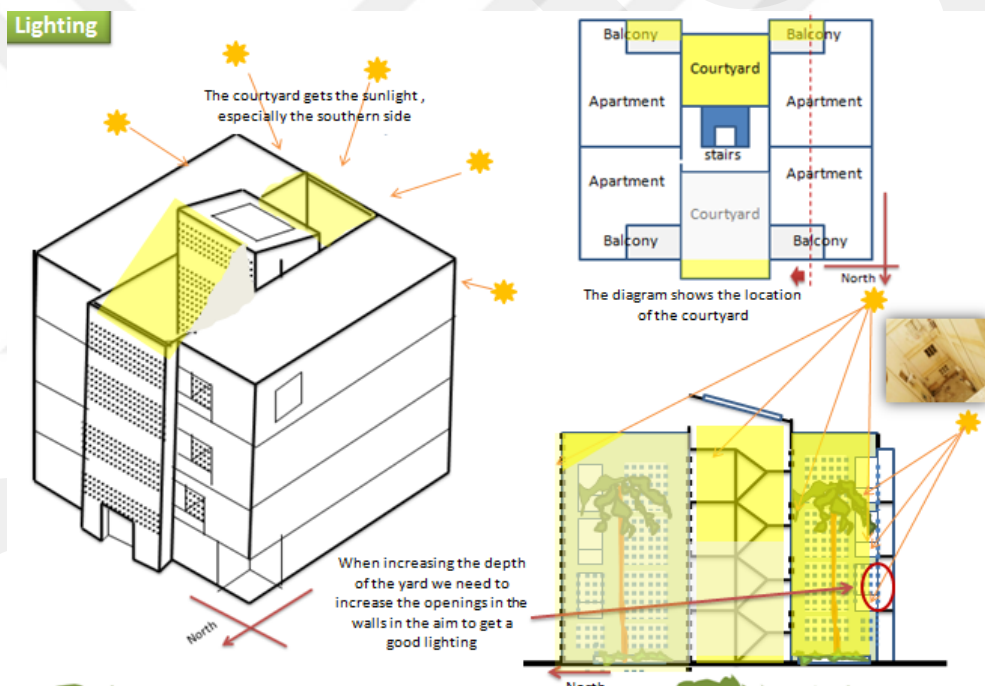
**Figure 4.35:** Example I – Solution for ventilation

Through Courtyards; the idea of this solution relies on creating two courtyards. The north yard faces the cool air using walls with small openings which are shaded all day. The north yard faces the south is sunny and hotter than the northern facades. The cool air moves from which the north yard to the space of the stairs through gaps if it were opened. Then to the second yard and the cold air replaces the hot air, which goes to the top directly, as shown in section above.

Through the hall of the stairs; the stair space can be used in two ways. First, the high roof which faces the north allows cold air to enter through the gaps and cool the hall of the stairs (in wintertime these gaps are able to close easily). Second, the northern facade of the stairs has openings, as shown in Figure 4.38, which allows the cool air to enter. Through Balconies and windows; the goal of having a wall with gaps in the balcony is to allow glass windows to be opened behind these walls without concern

for privacy because users can open their windows for ventilation and lighting without affecting their privacy.

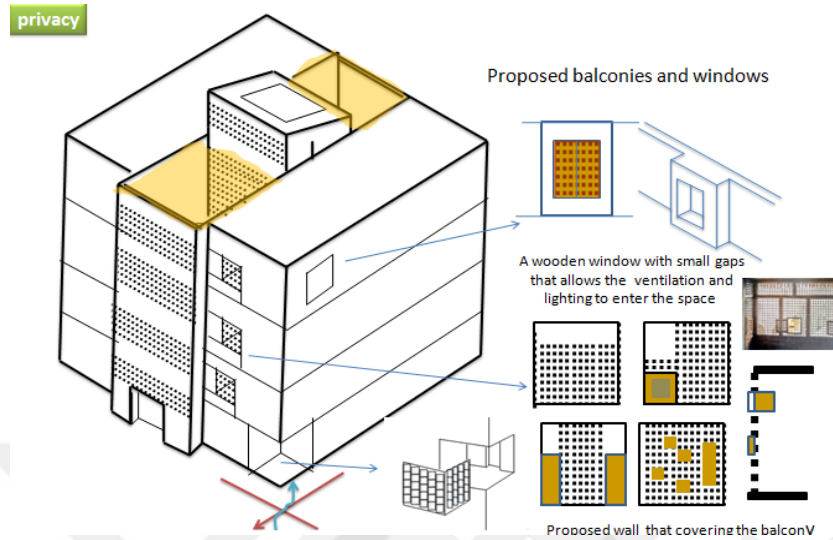
- **Lighting and heating solutions:** The southern courtyards provide natural lighting with solar radiation to the interior spaces, while the north courtyard provides only lighting without solar radiation, as illustrated in Figure 4.40. In addition to lighting by courtyards, the roof of the stairs provides natural lighting through the windows (these windows may be opened or closed as needed). The section illustrates the degree of lighting in the three spaces courtyards and the hall of the stairs. The benefit of the solutions is that they provide natural lighting and reduce dependence on electricity during the day as well as providing healthy natural lighting to indoor spaces.



**Figure 4.36:** Solution for lighting

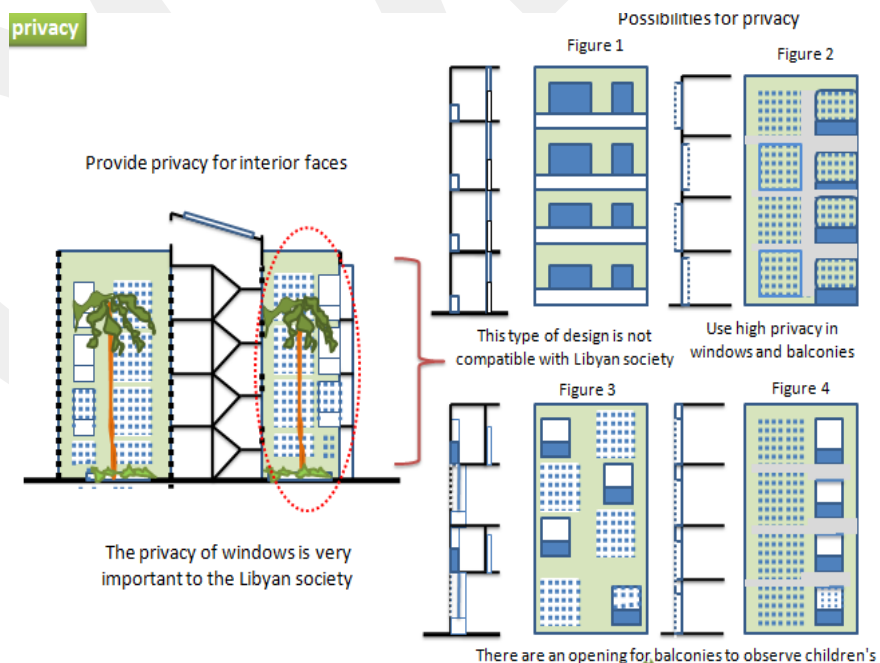
In the winter, the gaps of the north walls are closed, and the south courtyard helps to warm the surrounding spaces. In addition, local materials help to warm the spaces due to the thermal mass.

- Privacy and safety;** Privacy for balconies and windows: The proposed solution entails covering the balcony by the wall with gaps. All these solutions provide ventilation, lighting and privacy, as shown below.



**Figure 4.37:** Solution for privacy

Privacy for façades of the courtyard: There are three solutions to provide privacy in the courtyard faced. The first solution, (Figure 1), is not desirable for users because it does not provide privacy or safety. In Figure 2, a high degree of privacy for the windows and balconies is available. Figure 3 shows an open balcony and covering window, which is the same design as Figure 4.



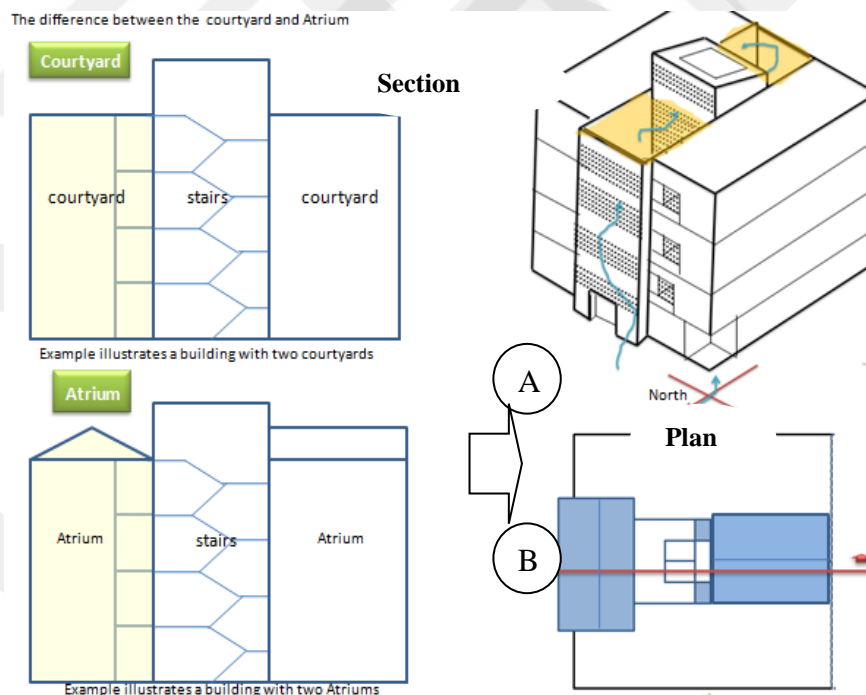
**Figure 4.38:** Privacy for façades of the courtyard

## b. 2. Example 2

This example examines the possibility of using an atrium instead of a courtyard. A brief comparison will occur between them in order to learn about the advantages and disadvantages of an atrium in a hot climate.

### Comparing between the use of a courtyard and an atrium in high-rise buildings

- **Courtyard in summer:** The southern courtyard receives direct sun heat that raises the heat gain in the summer. The proposed solution of walls with gaps located in the northern facades allows cool air to move from the north court to the south court. This makes the hot air in the southern courtyard rise and become replaced by cold air.
- **Atrium in the summer:** When cool air enters the south court, the hot air rises and returns again because the glass roof is closed, this makes the space very hot. Therefore, it is better to open the roof in the summer in order to allow hot air to escape.



**Figure 4.39:** Possibility of using atrium instead of courtyard

- **Courtyard in the winter:** The southern courtyard in the winter is warmer and sunnier than the north yard; therefore users should close any openings located on the northern facades in order to keep in the warmer air.
  - **Atrium in the winter:** The glass roof of the atrium helps to warm the spaces in the winter.

As a result of this example, the proposed solution is to design a courtyard with a roof that closes in the winter and opens in summer.

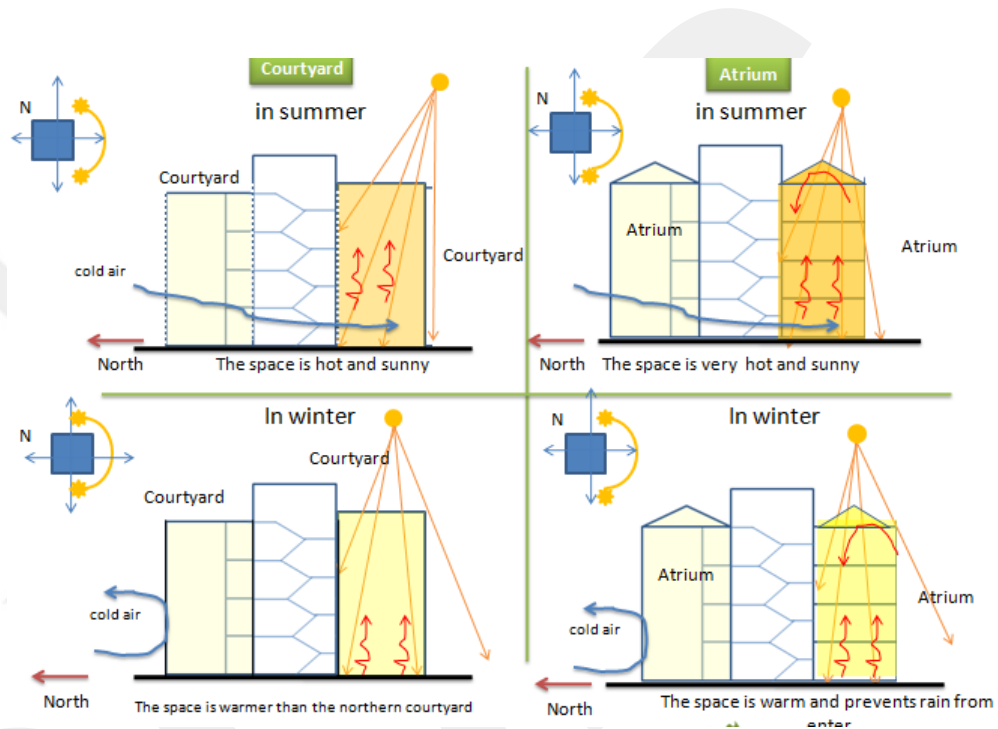
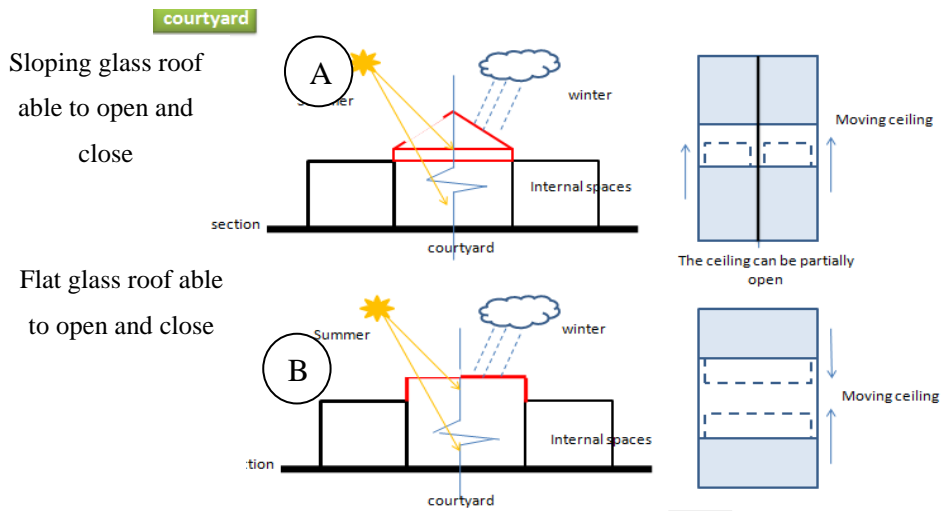


Figure 4.40: Analyses illustrate the disadvantages and advantages of these solutions.

## 4.2.2. Design model for existing buildings

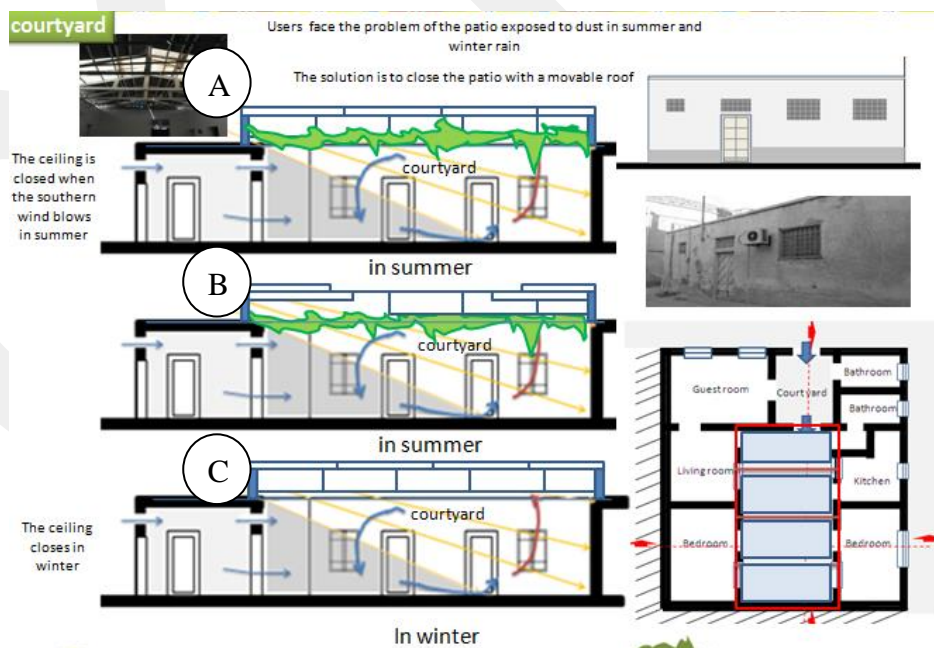
### 4.2.2.1. Existing traditional housing

In order to solve the problems of rain in the winter and being seen by neighbors in high buildings in courtyard housing, a solution would be to use a movable glass roof that opens in the summer and closes in the winter, as illustrated in the figure below. For example, in Figures A and B, the roof may be opened or closed as needed, thereby providing users a suitable space for social interaction without being affected by bad weather or by neighbors.



**Figure 4.41:** Solutions for existing traditional housing; the best solution to the problem of rain in the winter and dust in the summer entering is to close the space and open it as needed, as it illustrated here.

**Example of solving the problem in case study housing 1:** This example suggests covering the court with a glass roof which can be opened and closed as needed. The solution suggests placing plants below the glass roof in order to provide a comfortable atmosphere during the summer, as shown in the figure below. In addition, it is suggested to change reflective floors to floors made from local materials that do not reflect sunlight.



**Figure 4.42:** Solving the problem in case study housing 1

**Figure A:** In the summer, users can close the roof when the wind blows with dust.

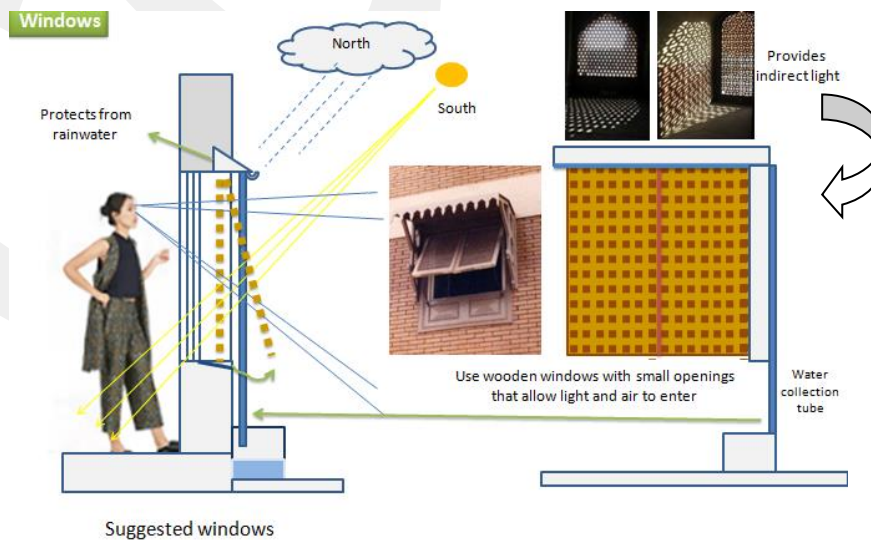
**Figure B:** In the summer, open the roof to allow the hot air to rise.

**Figure C:** In the winter, close the roof in order to keep in the hot air.

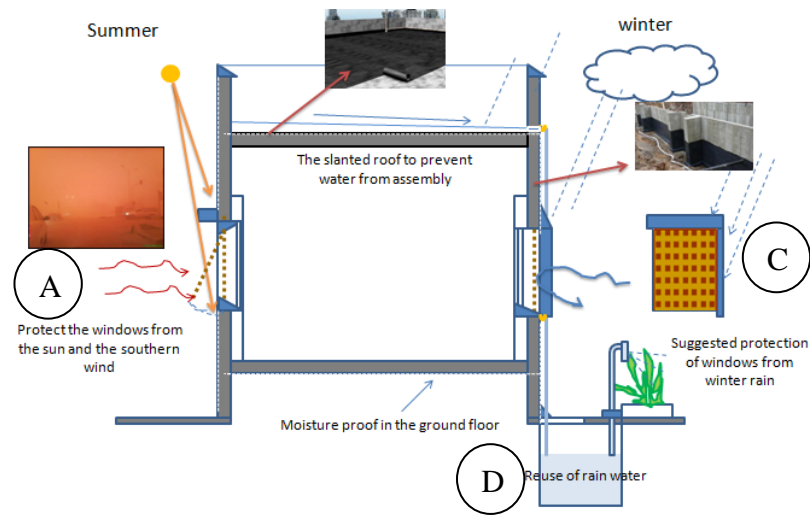
#### 4.2.2.2. Design a model for existing Apartments and detached house

The proposed solutions do not include all the building structure because it is difficult to change what has been designed previously; nevertheless, we can include the building envelope of windows, balconies, ceilings and stairs.

- **Solution for Windows:** consists of two parts. The interior glass is preferably double layered to provide more thermal insulation, and the outer envelope is preferably made from wood insulation. This wood window should have square openings to allow cold air and natural light to enter without affecting the privacy of users.
- **Solution for Balconies:** With aim of providing privacy and comfortable environment to the Libyan community, the solutions suggest that covering all the balcony facades, or part of them, for women to sit comfortably, as illustrated in Figure 4.43.
- **Solution for the roof:** The ceiling for the upper floors is preferred to be covered with plants that the Libyans use in ancient times as they will reduce the amount of sun heat on the roof in the summer.
- **Solution for the stairs:** The high ceiling of the hall of the stairs helps cold air to enter; thus, the solution suggests directing the upper windows to the north side to hold the cold air.



**Figure 4.43:** Solution for existing DH house and AP1; this figure illustrates the shape of the window and the manner of lighting the internal space. This kind of window provides space with natural lighting without affecting privacy.



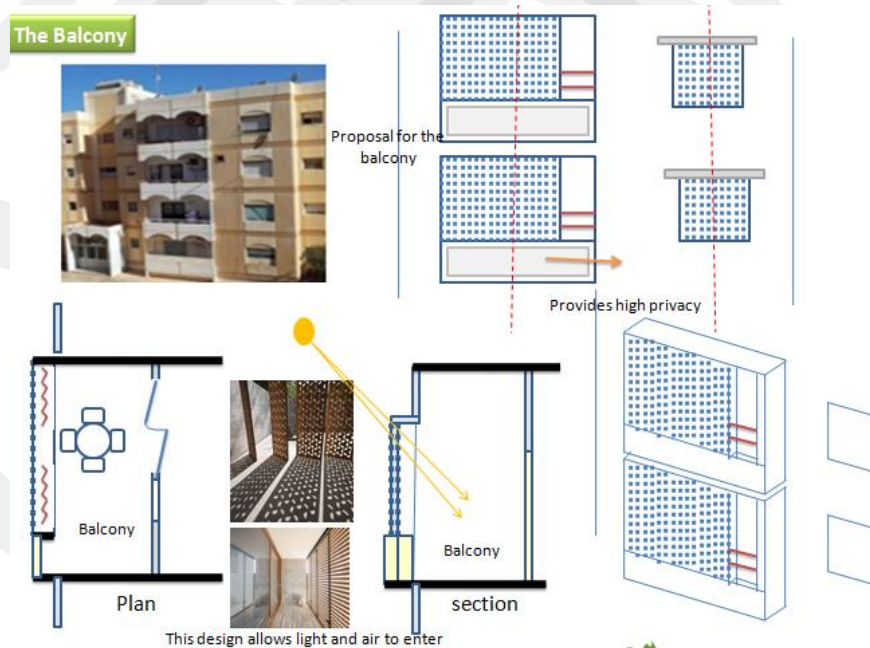
**Figure 4.44:** Solution for existing villa and Apartment 2

**Figure A:** Wooden windows can be closed when the dusty south wind comes.

**Figure B:** A layer of tar is used for insulation from the rain.

**Figure C:** Horizontal and vertical projection are used to prevent rain from entering.

**Figure D:** Taking advantage of collected rain water for watering plants or housework



**Figure 4.45:** Solution for existing DH and AP 3; the wooden cover of the balcony provides high levels of privacy in addition to lighting and ventilation without affecting privacy.

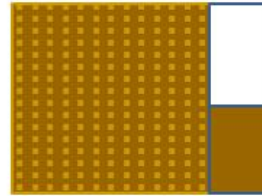
### The Balcony

The reality of the Balcony in Libya

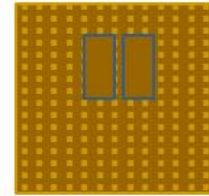


Examples exist in the Arab world

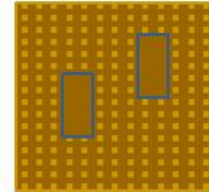
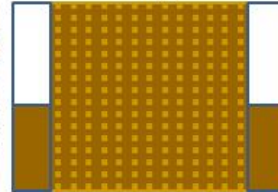
This model offers high privacy



Wall with gaps

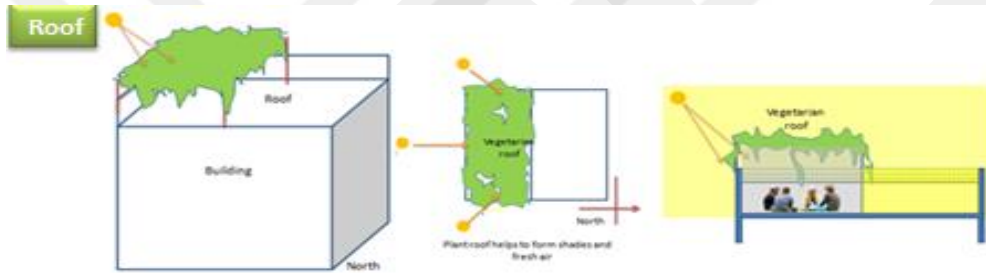


Small windows



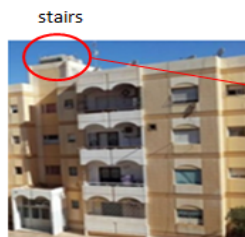
Proposal for types Balconies

**Figure 4.46:** Solution for existing DH and AP 4; different types covering the balcony, some of which have small windows

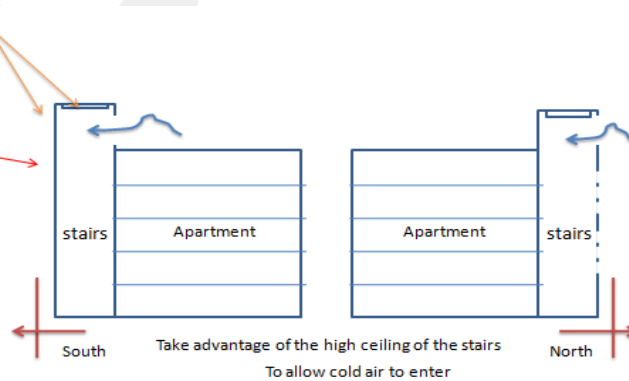


**Figure 4.47:** Solution for existing DH and AP; covering the roof with plants helps to reduce heat gain

### The stairs



Apartments



**Figure 4.48:** Solution to existing DH and AP 6; using high roof with a window that faces the north side

### 4.3. Providing water

As a result of the water and electricity shortages due to the war of 2011, it became necessary for people and the post-war government to find sustainable ways to meet people's needs of water in the future.

Water is available in the city and people are trying to gain access to this water without help from the state, especially after the war in 2011. The kind of water between good and polluted is explained here: "Water quality coefficient values showed that groundwater in the study area was good in only 14.3% of samples. Water was low in pollution at about 64.3%, and 21.4% of the samples under study were very poor and unsuitable for domestic purposes, especially drinking."(EI Osta, 2016).

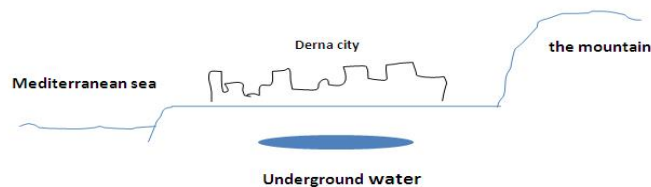


Figure 4.49: Underground water in Derna city ([www.google.com](http://www.google.com))

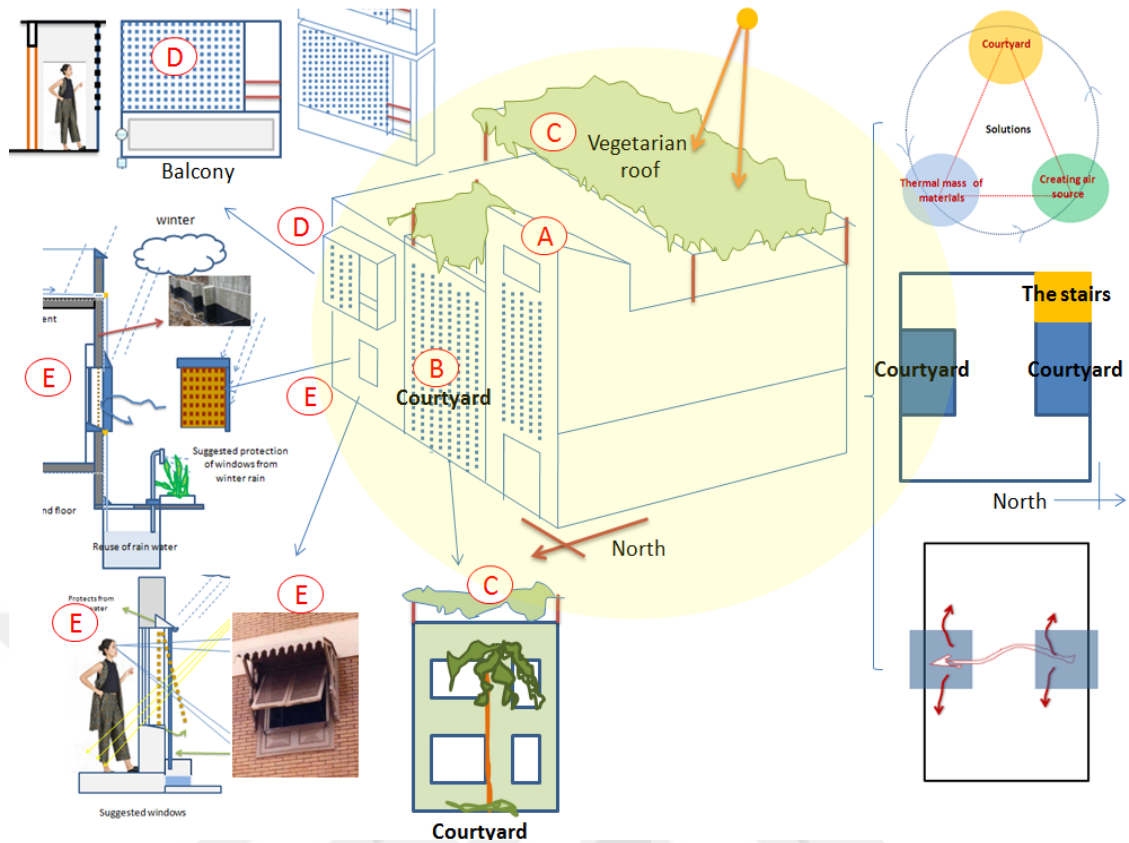


Figure 50: Location of ground water in Derna ([www.google.com](http://www.google.com))

#### **4.4. summary of solutions related to building envelop ( windows, walls, roof, balconies ) ;**

To achieve the goal of nearly zero-energy housing, some sustainable solutions are considered the design to be “one building, so The figure below illustrates the main aim of the solutions for the north face, such as taking advantage of any cold airflow to cool the indoor spaces during the summer and protect the face from rain and cold wind during the winter. Therefore there are main guidelines of Figure 4.54;

1. For north façade In summer time allow the north winds to enter in the building rooms through;
  - a) Designing walls with small openings
  - b) Designing a courtyard in north of building
  - b) Designing windows and balconies in north façade more than anther faced.
  - C) Minimize the obstacles that prevent the air to enter the building
  - d) Minimize the Trees and plants in north garden
  - f) the location of hall of the stairs should be in north of building as seen in figure 4.39(diagram A) by designing high roof to allow cold air to enter in the summer)
2. For north façade in winter the main solutions should consider to make the rooms warm are ;
  - a)Good insulation (thermal mass) of walls windows and doors as presented in figure 4.44
  - b)The open spaces which located in north side do not need covers like south spaces
  - c) The rain direction which come from northwest is still the big problem for building in case study area, so the west and north façade need solutions more than anther faced , in figure 4.44(diagram c) presented solution for this problem in aim to prevent the water to enter in the rooms such as ; Double glass, horizontal surface above windows and slope the bottom of the window and minimize the size of window and balcony in west faced.
3. As result of privacy needs, most window and balcony should be covered by Al Mshrabea as illustrated in figure 4.43



**Figure 4.52:** Design model for the north façade

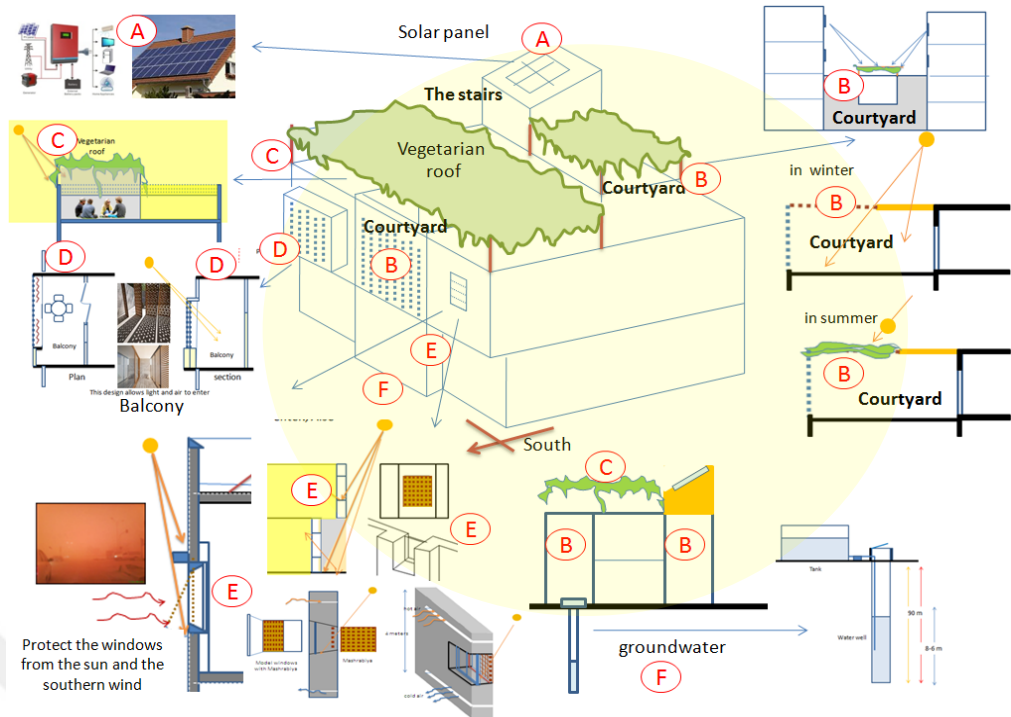
**Table 4.3:** Design model for the north facade

	Solutions	Kind of solution	Aim	Analysis
A	Stairs	High roof of stairs and good direction to the north	Ventilation and cooling in the summer	This solution allows cold air to enter indoor spaces.
B	North Courtyard	Two courtyards; one in the north and the other in the south	-To provide ventilation, cooling, heating and lighting -Provide social privacy	This solution creates air movement from north to south in order to cool the spaces in the summer and heat them in the winter as well as to enhance the lighting and ventilation systems.
C	Plants	Plant roofs were used by local people in ancient times.	To provide shade for the upper roof so as to avoid solar heat during the day	People used this kind of solution in their traditional housing on roofs and courtyards.
D	Balcony	Covered balcony	To provide privacy	This solves the problem of unused space because open balconies do not provide privacy for users .
E	Windows	Covered windows	1. To provide natural lighting without affecting privacy 2. To prevent cold air and rain from entering	1. The outer cover is made of wood with spaces allowing light to enter. 2. The inner glass is double layered so as not to allow rain or cold air to enter during the winter.

The important solutions for the south façade are presented as three main aims, the first of which is to be protected from the desert winds (called 'al-kably') in the summer. The second aim is to reduce the effect of solar heat. The third and final aim is to take advantage of solar heat to heat the indoor space, especially by south courtyard. So there are Main guidelines of Figure 4.55:

1. Due to issue of sun heat in summer time, windows and balcony are preferred to be covered with plants or wood roof.
2. the open spaces of garden and roof should be covered by plant as presented in figure 4.55(diagram C)
3. the roof of building and hall of the stairs in which face the sun are the best space for solar panel as illustrated in figure 4.55(diagram A)
4. The good location for plant and tree in south side to minimize sun heat.
5. The covered courtyard is preferred due to the privacy need figure 4.55(diagram B)
6. It is necessary to protect the windows from the southern winds as presented in figure 4.55(diagram E) like double glass, horizontal surface above windows and wood covered.
7. Wide walls are required in the south and west side ( thermal mass ) figure 4.55(diagram E)

the high roof which faces the north allows cold air to enter through the gaps and cool the hall of the stairs (in winter time these gaps are able to close easily).



**Figure 4.53:** Design model for the south façade

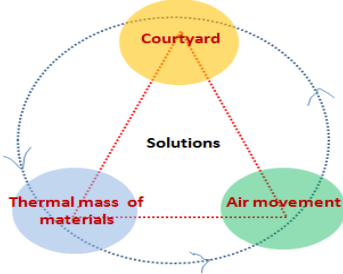
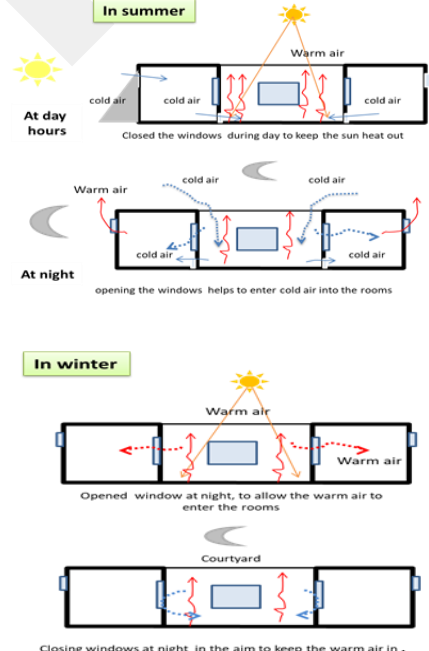
**Table 4.4:** Design model for the south façade

	Solutions	Kinds of solution	Aim	Analysis
A	Hall of the stairs	Works as wind catcher	cooling aim	The high roof which faces the north allows cold air to enter through the gaps and cool the hall of the stairs (in winter time these gaps are able to close easily).
B	South Courtyard	Facing the heat of the sun	-To provide ventilation, cooling, heating and lighting -Provide social privacy	In summer, it is covered by roof plants and the gaps in the walls can be closed if needed In winter, the space faces the sun, which allows for heat gain
C	Plants	Roof plants	To provide shade and privacy and reduce the impact of desert winds (named 'al-kably')	In summer, it provides shade and reduces heat gain In winter, the plants drop their leaves. This allows light to enter the courtyard.
D	Balcony	Covered balcony	1. To prevent direct solar radiation 2. To provide privacy	Gaps can be closed when the desert wind blows.
E	Windows	Covered windows	To provide privacy, lighting and ventilation	1. The wooden cover has gaps that allow air and light to enter and reduce direct solar radiation. 2. Double glass prevents hot air from entering.
F	The Well	Drilling wells inexpensively	To provide suitable water for drinking	People in the past provided water by drilling wells. Water is available and suitable for drinking at depths of between 8 and 90 meters.

#### 4.5. Guidelines for designing passive housing in hot hummed climate;

This table presented the main guidelines for sustainable housing in hot hummed climate. Most of these solutions come from traditional housing in Libya as it is a case study area. These guidelines will be useful for people to life in sustainable housing with good natural indoor environment with low energy consumption, as well as providing social need of privacy.

**Table 4.5:**Guidelines for designing passive housing

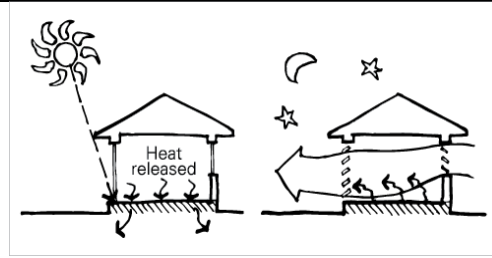
Solution Future For Housing on idea	Solution example
<p>The Comprehensive Solution which the sustainable housing of nearly zero energy building should include three elements of ;</p> <ul style="list-style-type: none"> <li>a) Courtyard</li> <li>b) Thermal mass</li> <li>c) Air movement</li> </ul>	
<p>a) <b>Courtyard ;</b> The courtyard plays the main role in ventilation, cooling and heating system in traditional housing.</p> <p><b>In the summer,</b> at night cool air flows into the rooms through the windows and doors and replaces the hot air which exits through high openings in the walls. During the day when the sun heats the courtyard, the space closing the windows and doors helps to keep the rooms cool.</p> <p><b>In the winter,</b> during the day the sun heats the courtyard and hot air enters the rooms, which helps to gain heat. At night, keeping the doors and windows closed helps to warm the space.</p>	

**b) Thermal mass**

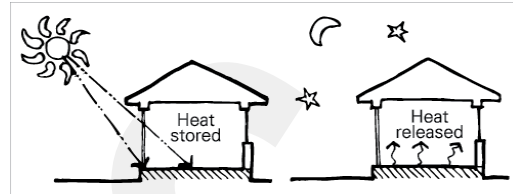
Thermal mass is a material's resistance to change in temperature

**In the summer**, it helps to keep indoor spaces comfortable by closing the windows during the day and opening them at night in order to release the warm air, as shown in Figure A

**In the winter**, it helps to keep the spaces warm by storing heat during the day and releasing it at night, as shown in Figure B , Reardon (2013)



**In Summer; fig A**



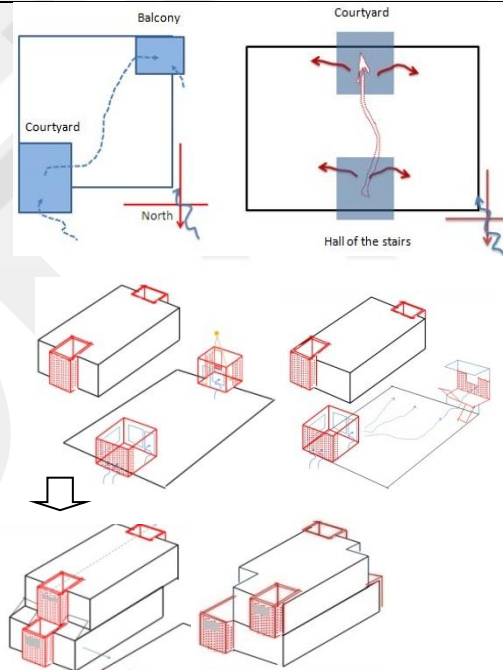
**In Winter; fig B**

The capacity of the local materials to store the heat during the day and release it at night

**c) Air movement**

This idea depends on air movement from a cold zone (high pressure) to a warm zone (low pressure). This type of solution in the figure allows cold air to flow from the courtyard to the balcony or from the hall of the stairs to the courtyard; hence, the idea based upon the findings of the case study houses in the last chapter.

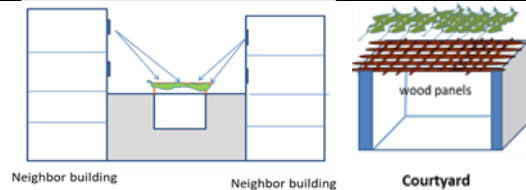
Air follows in the building; in this example, the cold air moves from the north zone to the south zone, or from the northwest zone to the southeast zone



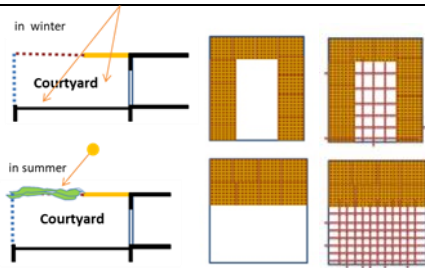
**Solutions for Courtyard- For Traditional existing house**

**Solution example**

**Issue;** the problems of rain in winter and courtyard being seen by neighbours from high buildings



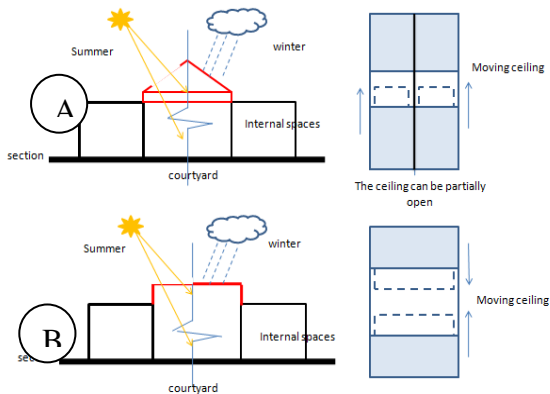
**Solutions** ;Cover the courtyard by plant in the aim to provide privacy



Examples of covering the courtyard

**a. Cover the court of traditional existing house**

The solution would be to use a movable glass roof that opens in the summer and closes in the winter, as illustrated in this figure. For example, in Figures A and B, the roof opened or closed as needed, thereby providing users a suitable space for social interaction without being affected by bad weather or by neighbours



Sloping glass roof able to open and close

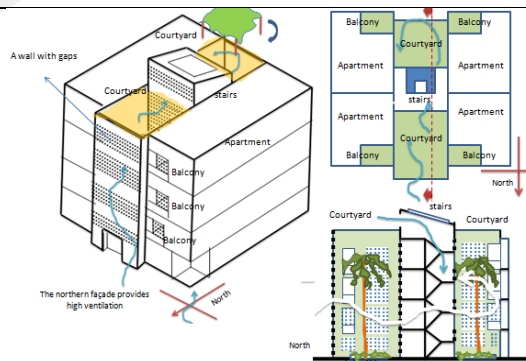
**Atrium -for high –rise apartments**

**Solution example**

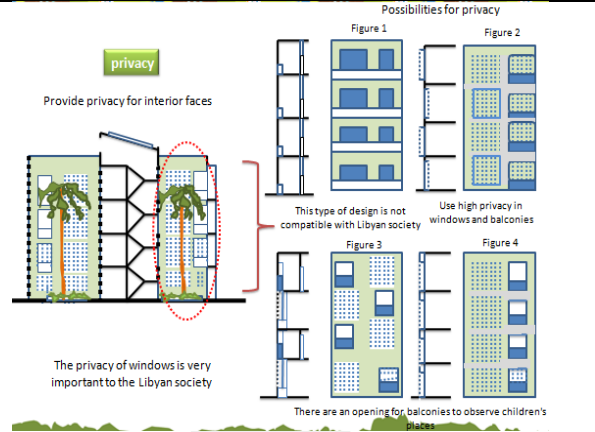
The problem of died space ( space did not use from users )



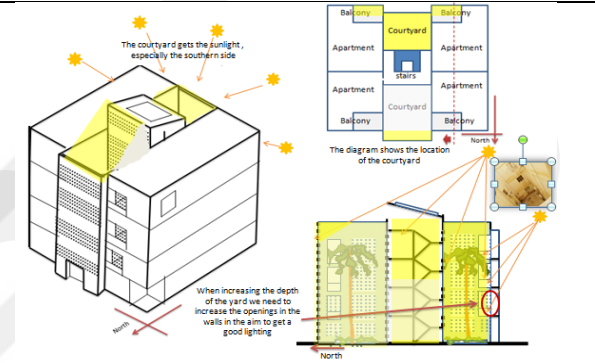
**-Ventilation and cooling:** The four suggested solutions aim to make the cool air enter the indoor space without obstruction in the northern facades, such as the courtyards, roof of the stairs, the balconies and wooden windows, which are explained as follows



**Privacy for façades of the courtyard:**  
 There are three solutions to provide privacy in the courtyard faced. The first solution, (Figure 1), is not desirable for users because it does not provide privacy or safety. In Figure 2, a high degree of privacy for the windows and balconies is available. Figure 3 shows an open balcony and covering window, which is the same design as Figure 4.



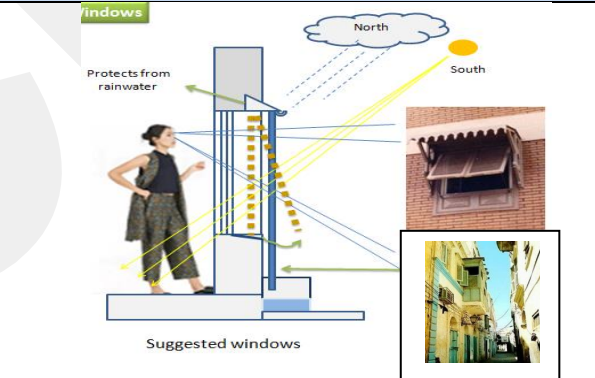
**-Lighting and heating solutions:**  
 The southern courtyards provide natural lighting with solar radiation to the interior spaces, while the north courtyard provides only lighting without solar radiation



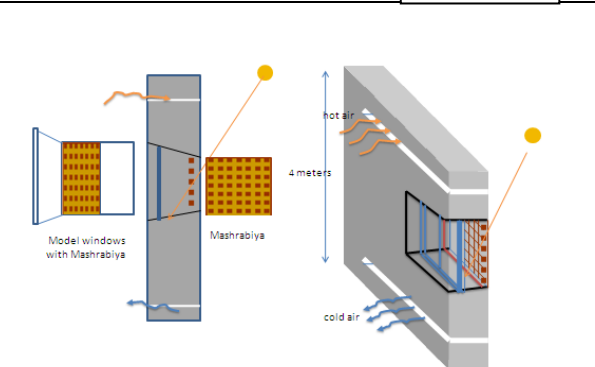
**Solution for Windows - For All kind of housing**

**Solution example**

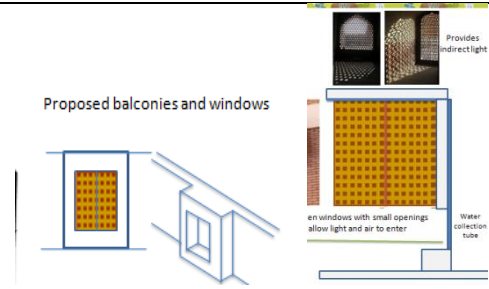
**Idea of solution ;** The solution come from Mshrabea  
**Privacy;** This kind of window provides space with natural lighting without affecting privacy.



consists of two parts, The interior glass is preferably double layered to provide more thermal insulation, and the outer envelope is preferably made from wood insulation. This wood window should have square openings to allow cold air and natural light to enter without affecting the privacy of users.



A wooden window with small gaps that allows the ventilation and lighting to enter the space

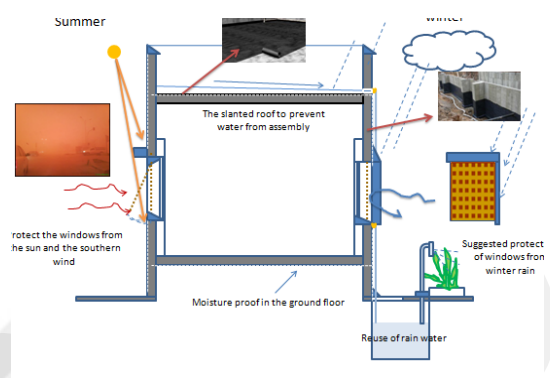


**Figure A:** Wooden windows can be closed when the dusty south wind comes.

**Figure B:** A layer of tar is used for insulation from the rain.

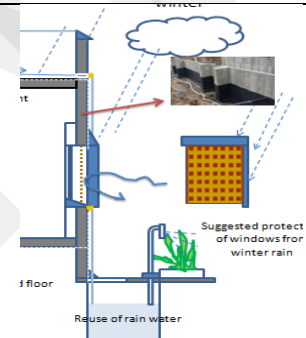
**Figure C:** housework Horizontal and vertical projection are used to prevent rain from entering.

**Figure D:** Taking advantage of collected rain water for watering plants or housework



**Solution for rain**

The inner glass is double layered so as not to allow rain or cold air to enter during the winter.

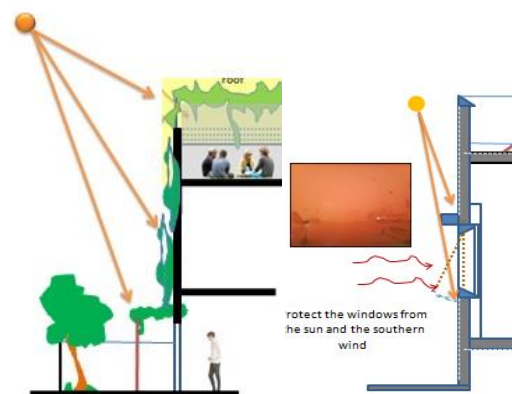


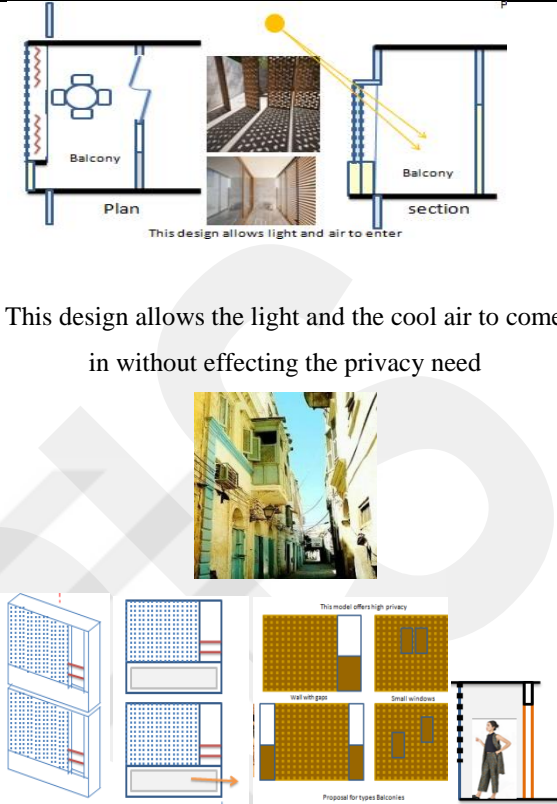
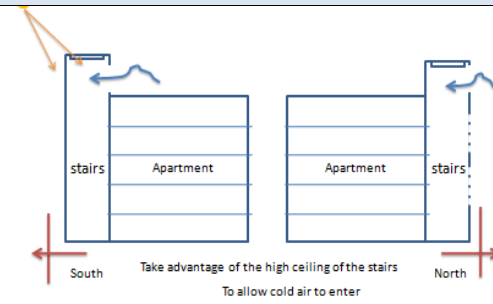
**Solution for desert wind**

Using plant in the aim of providing shade and privacy and reduce the impact of desert winds (named 'al-kably')


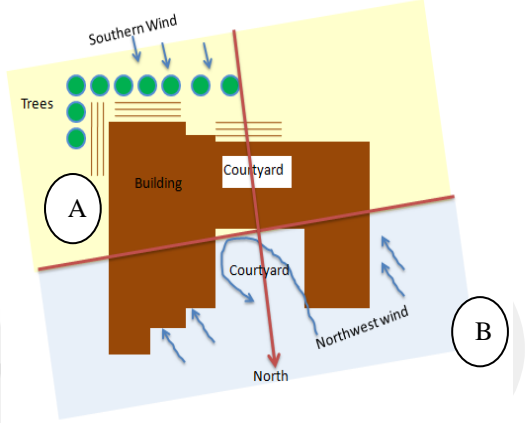
**In summer,** it provides shade and reduces heat gain

**In winter,** the plants drop their leaves. This allows light to enter



<p align="center"><b>Solution for balcony</b> <b>For Contemporary housing ,( existing and new housing )</b></p>	<p align="center"><b>Solution example</b></p>
<p><b>Idea of solution ;</b> The solution come from Mshrabea</p> <p><b>Privacy solutions ;</b>With the aim of providing privacy and comfortable environment to the Libyan community, the solutions suggest that covering all the balcony facades, or part of them, for women to sit comfortably,</p> <p>different types covering the balcony, some of which have small windows</p> <p>The proposed solution entails covering the balcony by the wall with gaps. All these solutions provide ventilation, lighting and privacy</p> <p>The goal of having a wall with gaps in the balcony is to allow glass windows to be opened behind these walls without concern for privacy because users can open their windows for ventilation and lighting without affecting their privacy</p>	 <p>This design allows the light and the cool air to come in without effecting the privacy need</p> <p>This model is derived from traditional design of (Mshrabea)</p>
<p align="center"><b>Solution for Hall of the stairs</b> high –rise apartments, and detached house ,(existing and new housing)</p>	<p align="center"><b>Solution example</b></p>
<p><b>Role of hall of the stairs in cooling and ventilation ;</b></p> <p>The stair space can be used in two ways;</p> <p>First, the high roof which faces the north allows cold air to enter through the gaps and cool the hall of the stairs (in winter time these gaps are able to close easily).</p> <p>Second, the northern facade of the stairs has openings, which allows the cool air to enter.</p>	 <p align="center">Take advantage of the high ceiling of the stairs To allow cold air to enter</p> <p align="center">Wind catcher</p>

<p>The cold air enters through the northern façade to the space of the stairs and replaces the hot air which goes to the top.</p> <p>Second, the cold air moves into the yard and enters the apartment rooms through the wall openings as illustrated in this figure.</p> <p>The northern apartments will receive the largest amount of cold air in the summer while the southern apartments will receive the cool air from the southern courtyard</p>	<p>The section illustrates the degree of lighting in the three spaces courtyards and the hall of the stairs.</p>
<p style="text-align: center;"><b>Using plant For All kind of housing</b></p>	<p style="text-align: center;"><b>Solution example</b></p>
<p>Using plant in the aim of providing shade and privacy and reduce the impact of desert winds (named 'al-kably')</p> <p><b>In summer</b>, it provides shade and reduces heat gain</p>	<p>Using the plant in south façade help to reduce the sun heat in summer time</p>
<p><b>In winter</b>, the plants drop their leaves. This allows light to enter</p> <p>The ceiling for the upper floors is preferred to be covered with plants that the Libyans use in ancient times as they will reduce the amount of sun heat on the roof in the summer</p>	

Orientation For New housing	Solution example
<p><b>Good orientation of the building</b></p> <p>The wind direction in case study area is North West direction, therefore the table presented the solution for good orientation of case study area .</p>	 <p style="text-align: center;">Wind direction</p>
<p><b>The relationship between Building and wind direction ;</b></p> <p>The best direction when the building faces the north west winds in two sides as illustrated here.</p> <p>This solution aimed to</p> <ol style="list-style-type: none"> <li>Protect the southern façade from desert winds</li> <li>Cold wind in summer is desirable so exposing the building to north west wind as possible</li> </ol>	 <p style="text-align: center;">The northwest wind is required in summer time will the desert wind which come from south did not required</p>

#### 4.6. Example of guidelines for housing;

This part of the study presented the main suggested guidelines in one example in the aim to make this study more useful and helpful for designing a sustainable housing in hot humid regain. The table below presented some suggested requirements for users ( all these requirements came from result of Questionnaire analysis) , moreover the idea of design depended on result of this study of environment solutions ( natural ventilation, cooling ,lighting and heating ) and social needs ( privacy and safety ) which are applied in this example in figure ;

**Table 4.6.** Suggested a house for one family

<b>Kind of information</b>	Users information
<b>Number of family</b>	One family
<b>Number</b>	Parents and four children
<b>Functional requirements</b>	Guest room Apartments for future growth of family In door open space for women
<b>Traditional and Islamic needs</b>	Separate between rooms of women and Strangers men Privacy in outdoor and indoor environment is important
<b>Environmental requirements</b>	Provides natural ventilation, cooling lighting and heating
<b>Style of housing</b>	Ground floor for original family (Parents and four children) Future floor for new family So the style like apartments

##### a) **The ground floor;**

divided into four parts; private space for sleeping room , semi-private space for living room and a kitchen , space for guests isolated from family space with Insulated door , courtyard space for women to sit which provide high privacy with esthetic environment .King of guidelines for ground floor;

- The courtyard provides a warm environment in winter and cool environment in summer
- Local materials help to enhance thermal comfort of building
- Most rooms open on courtyard
- Provide privacy for external windows by wall with gaps
- Create moving air from the North Face to the yard through the gaps

- Provide natural environment in courtyard

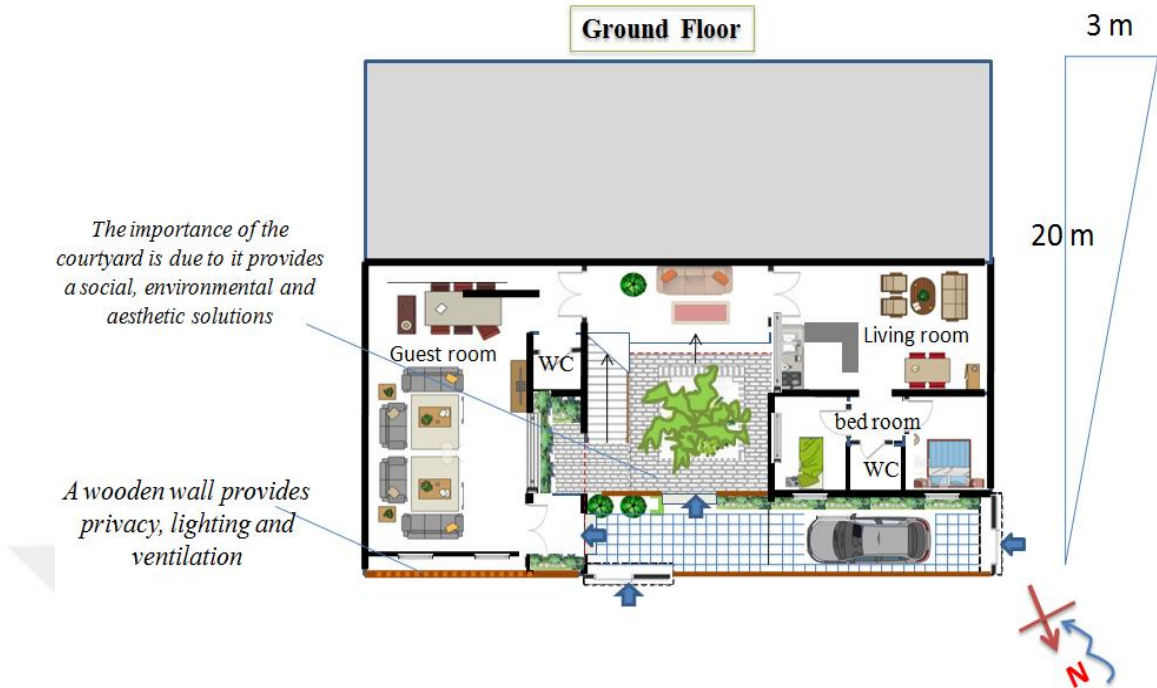


Figure 4.54; the courtyard provides a comfortable and beautiful environment for users

Without affecting the privacy

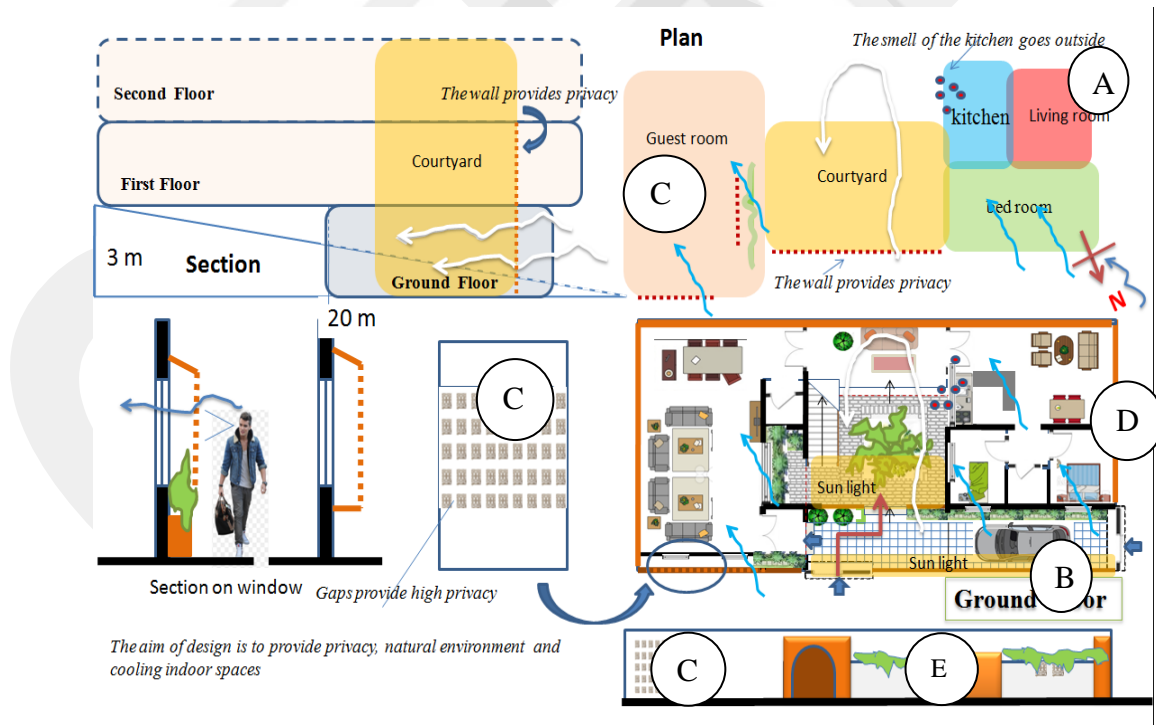


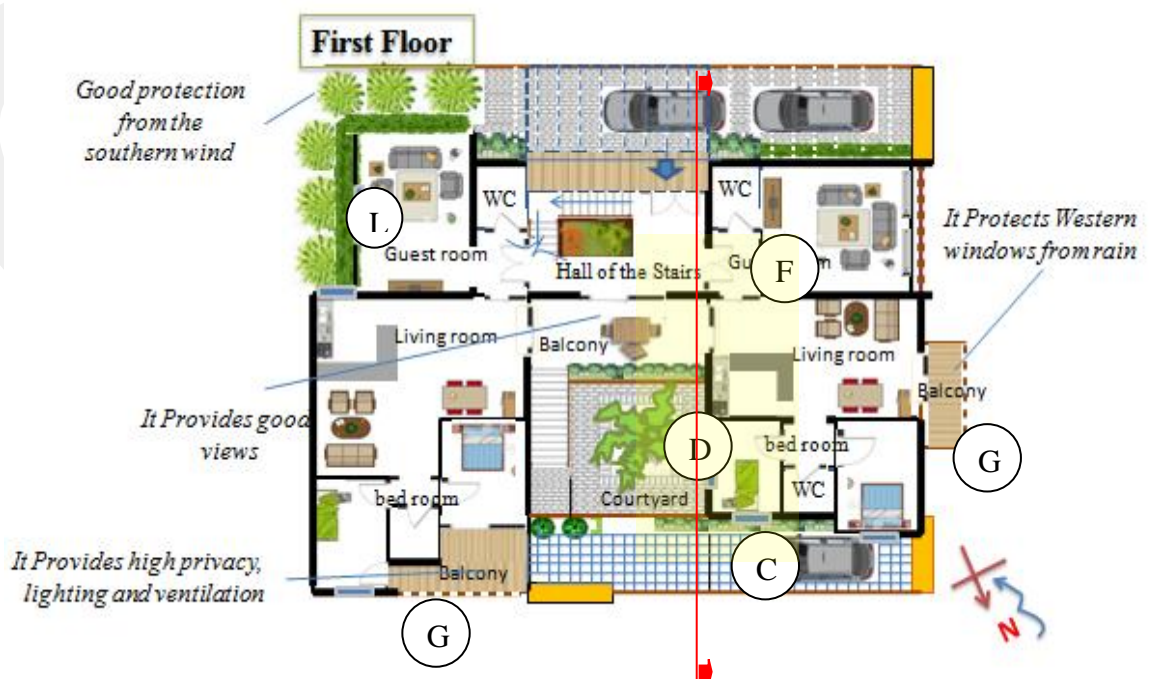
Figure 4.55; building analyses

**Table 4.7.** key of figure

	<b>Solution</b>	<b>Reason</b>
<b>A</b>	Provide privacy for spaces	Social need
<b>B</b>	Privacy for main door and courtyard	Social need
<b>C</b>	Provide privacy from outside Ventilation and cooling solution	Social need and environment need for ventilation and cooling in summer time
<b>D</b>	Courtyard space for many goals	Social need for enhanced the privacy environment need for ventilation, cooling , heating and lighting
<b>E</b>	High Fence -2M	For privacy -social needs

**b) First floor;** Used for vertical expansion for new family, the floor has two apartments with good view on courtyard; the apartment has privacy for social need ; King of guidelines for first floor;

- Design landscape with trees on the south garden in aim to reduce the son heat and the effect of desert wind
- Climbing plants help to reduce heat gain in southern façade
- Provide high privacy of the balcony by wall with gaps
- Western windows are protected from rain by wall with gaps
- The hall of the stairs Helps enter cold air into building rooms through doors and windows
- There is balcony For social interaction that provides privacy



**Figure 4.56;** this floor illustrated the solution of, Courtyard, hall of the stairs, balcony

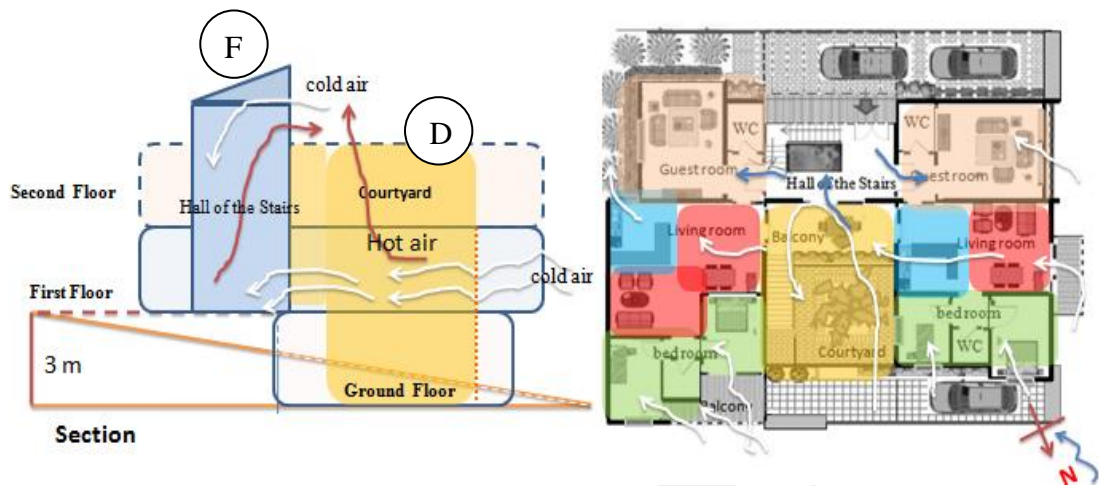


Figure 4.57; building analyses

Table 4.7; key of figure 4.57

	Solution	Reason
F	The hall of the stairs works as wind catcher	Ventilation and cooling
G	Balcony covers by wall with gaps	Privacy- social need
D	Courtyard	Social need which enhanced the privacy environment need for ventilation, cooling , heating and lighting

**Second floor** ; this floor is designed for future expansion for new family. It is same the first floor design and has same solutions,

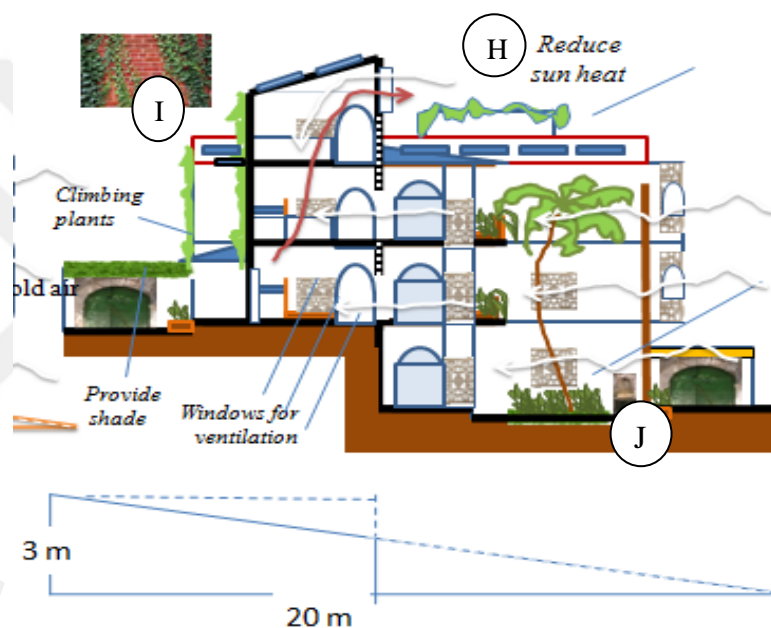


Figure 4.58; the plan show us the main solutions

**Section;**

The section presented kind of solutions of courtyard and hall of the stairs. For example, courtyard cools the indoor space in summer and heat the in winter. Hall of the stairs works as wind catcher.

- The aim is to allow the cold air to enter the Hall of the stairs then enter to the rooms through the windows and doors
- The plant covered the south façade in aim to reduce the sun gain
- All windows have a privacy in their design as presented here



**Figure 4.59;** section the hall of the stairs works as wind catcher

**Table 4.8;** key of figure 4.59

	Solution	Reason
H	plant roof	Provide shade
I	Climbing plants	Reduce sun heat
J	Courtyard with plant and water	-Palm allows air to pass without obstruction -Plants play an aesthetic role in designing the courtyard -water help to cool the space

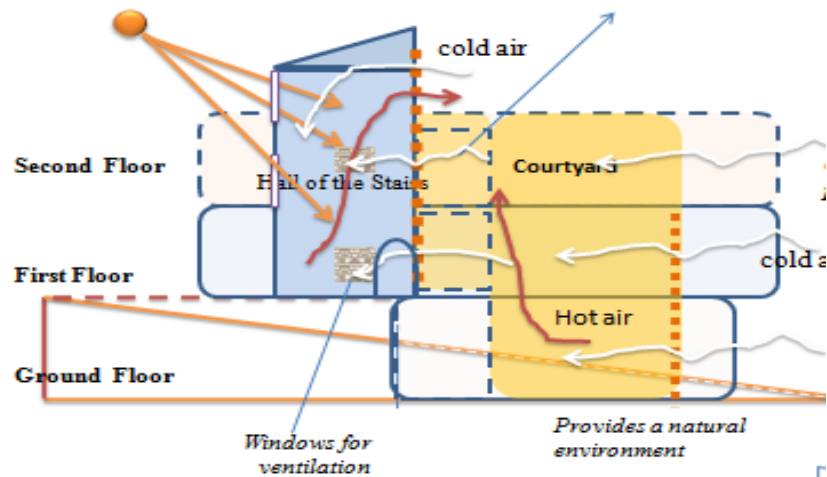


Figure 4.60; section analysis

**façade :**

As illustrated in figure below there are many solutions for balconies, windows and walls that enhance the indoor environment to be more ventilation, cooling and lighting. The design of these solutions depended on privacy factor .therefore all solutions respect social needs of privacy. For example, the gaps in walls allow the cool wind to enter the courtyard without effect the privacy. Moreover Windows have design solution from rain and allow the light and cool air to enter the rooms without effect the privacy. Finally, all balconies have role of traditional design of Mshrabea.

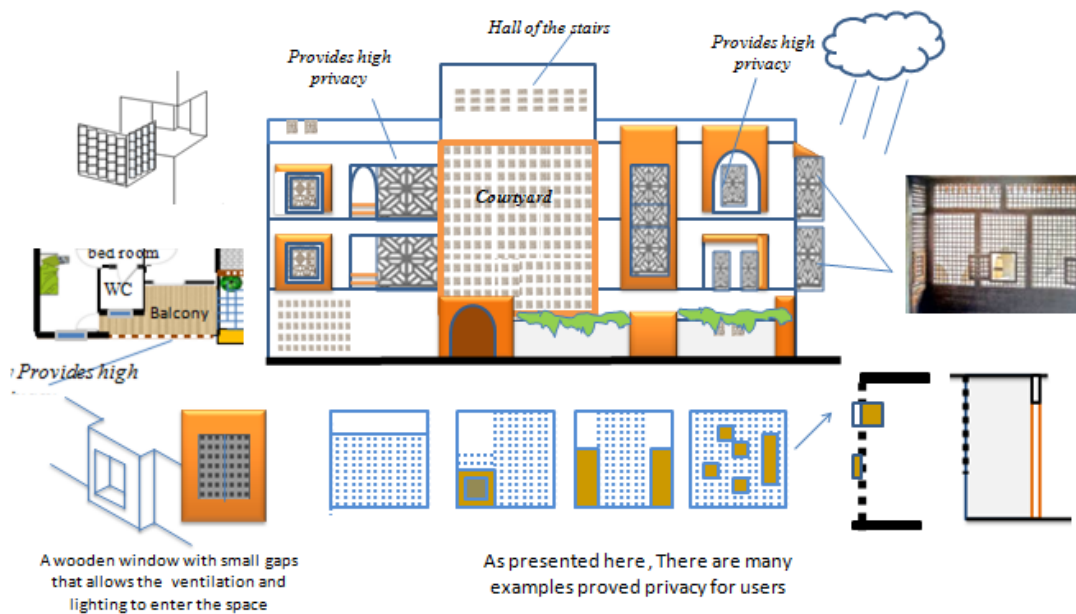


Figure 4.61; guidelines for façade

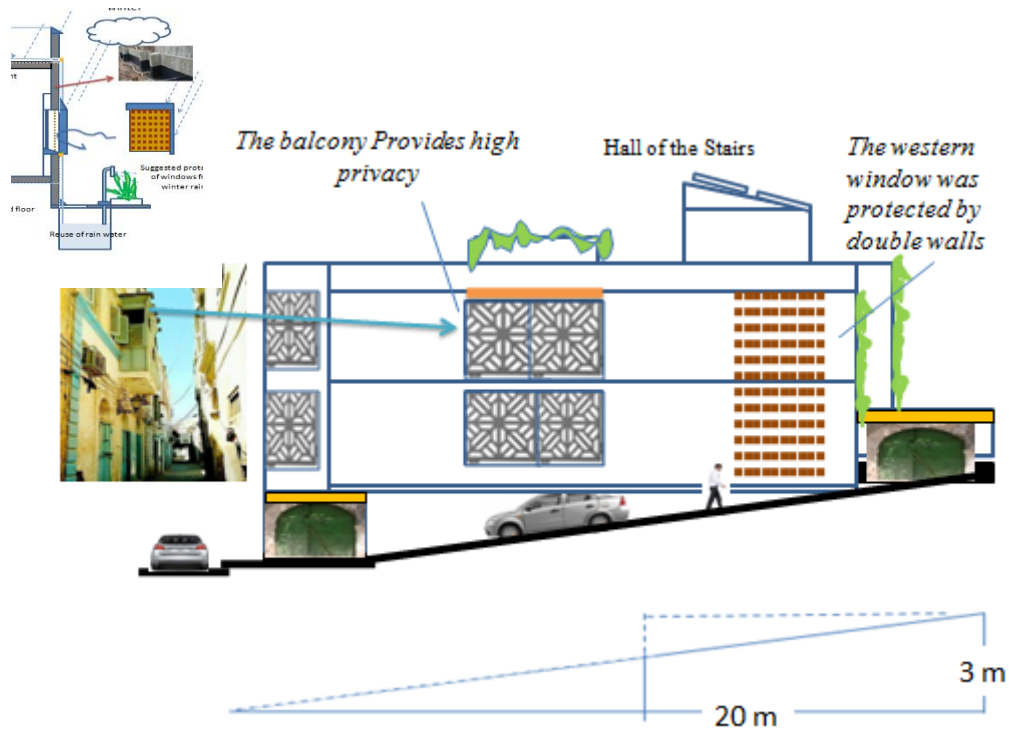
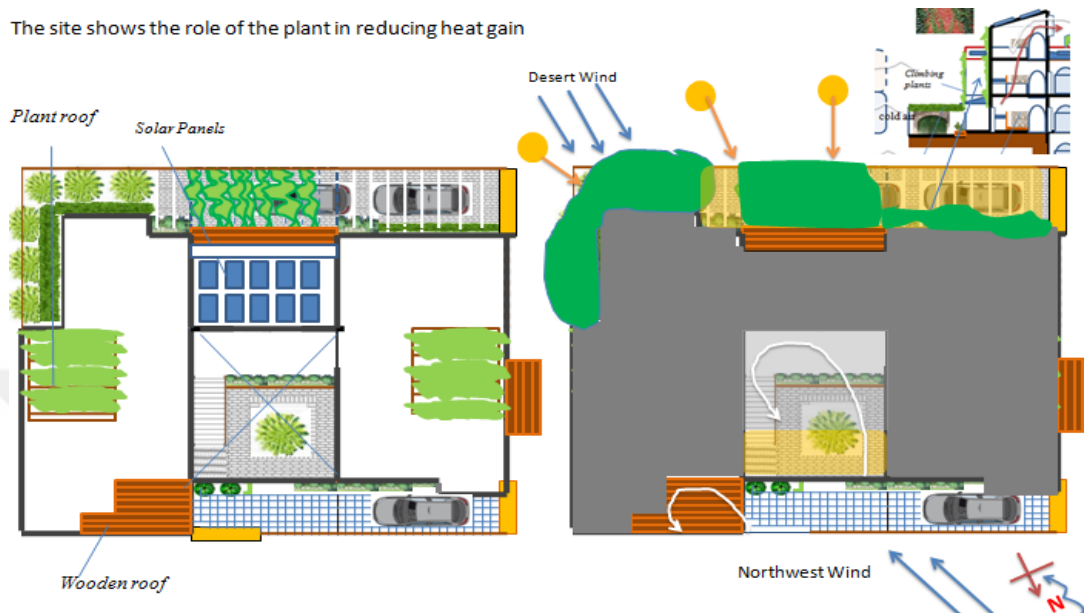


Figure 4.62; kind of guidelines



Figure 4.63; kind of guidelines

**Site plan;** the plant plays an important role in reduce sun heat in the summer time, for example ; The problem of the southern façade is that it receives a lot of radiation in summer, therefore high trees placed in south garden in aim to reduce sun heat and provide shadows



**Figure 4.63;** role of plant in site

#### 4.6. Conclusions

This study focused on solving the environmental, social and economic problems that users encounter in contemporary examples of housing in hot humid regions. Therefore, the proposed solutions relied on strategies of the advanced sustainability of nearly-zero energy buildings with the aim of solving these problems effectively. For this reason, the research methodology depended on a questionnaire and a field survey on both traditional and contemporary housing. In this case, the main finding of the questionnaire revealed the problems that users faced in contemporary homes, while the case study of traditional housing revealed number of sustainable solutions that can be taken into consideration to reduce energy consumption. These solutions rely on three points, the first of which is to take advantage of housing with courtyards due to the benefits of cooling, heating and providing an appropriate social environment for women to live. The second point is to design buildings that use local materials with a characteristic of thermal mass, which helps the indoor spaces to be cooler in the summer and warmer in the winter. The final point is the

creation of airflows from one place to another with the aim of cooling and ventilating the space during the summer. All these solutions will be applicable as they are derived from the traditional courtyard house design in northern Libya, there by achieving a type of the nearly-zero energy building in the future. As a result, the traditional courtyard housing would be rich in sustainable solutions which would help designers to achieve the goal of producing a nearly-zero building effectively.

## **CHAPTER V**

### **CONCLUSIONS AND RECOMMENDATIONS**

#### **5.1. DISCUSSION**

In this part of the study will discuss the results of the questionnaire and the case study. And comparing these results with previous studies. As well as investigate whether these findings will answer the hypothesis of the study. The first finding of the questionnaire reveals the problematic issue of environmental and social factors, such as high energy consumption related the dependence on air conditioning to supply cooling at a rate of 90% in TH, 60% in AP and 80% of users in V, while users are heating their spaces using electrical boilers at an average of 75% in AP, 80% in TH and 75% in DH. Moreover, with the issue of privacy, the study found that users created their own solutions to achieve the required privacy, such as high walls, covered windows and covered balconies. Those solutions were 90% of covered windows in TH, while these solutions were implemented at an average of 65% in AP and 55% in DH. Additionally, due to the non-availability of electricity, users are now lighting their homes with generators at an average of 65% in TH, 97% in AP and 80% in DH.

The second finding of the case study housing was that owners of the case study houses stated that their traditional courtyard housing succeeded in creating a suitable indoor environment in terms of natural lighting, ventilation, cooling and heating. Moreover, they were satisfied with the environmental level except for the owner of the first case study housing as he preferred some solutions in the contemporary house, such as ventilation and the privacy system. Furthermore, the findings revealed that the owner of TH living now in the AP type preferred the traditional house more than the contemporary house in terms of providing ventilation, cooling, heating and lighting systems. Finally, the findings also examined “What was the reason for the owner to move from traditional housing to contemporary housing?”

(Even when they liked living in TH), their answers were due to the problem of the traditional structure not resisting the vertical expansion of the building for new floors and the courtyard being exposed to rain and sight of neighbors in adjacent high buildings.

We compare the research findings with previous studies in terms of the issue of contemporary housing and the possible environmental solutions of traditional courtyard housing as follows: first, the findings of the research proposed that contemporary housing would rely on electricity to provide cooling in the summer and heating in the winter, which means that contemporary housing suffered from energy consumption problems (as shown in our questionnaire results); this is consistent with previous studies by Elwefati [22]. Furthermore, Elwefati criticized modern concrete buildings in Libya as they were not suitable for the local climate because of their uncomfortable indoor spaces and high energy consumption. Therefore, Elwefati recommended using local materials in order to reduce energy and money consumption. Elwefati states: “To provide an appropriate construction materials to the local environment, and reduce the high cost of the construction Operation” [22]. Additionally, Al- mansuri, [6] discussed the problem of new construction in Tripoli, Libya from the perspective of energy consumption by mentioning that “it is applied without complete understanding of their side effects.” In her study, she states that indoor spaces rely on mechanical air conditioning to provide thermal comfort and that designing housing without consideration of the local environment led to huge side effects. Finally, Al-Mansuia recommended we “highlight some architectural solutions that contribute to reducing building’s energy consumption as well as creating an architecture related to the local environment and place” [6]. As a consequence, our study findings in this part agree with previous studies in terms of energy consumption because housing are affected by using concrete structures.

Second, we compare the research findings with previous studies in terms of the provision of possible environmental solutions for traditional courtyard housing, such as designing future housing with courtyard spaces and using local materials. The study of [6] presented the advantages of using local materials and the disadvantages of modern materials. She claimed that the issue of contemporary housing occurs due to using a concrete structure, its high cost and its side effects. Nura aimed to reduce

the cost of buildings and adapt them to the local environment to achieve a green house. Finally, she recommended that natural materials from the local environment will have many benefits, including no side effects on the environment as well as reducing the cost of construction, which in turn lowers costs for the community. Furthermore, using natural materials helps to achieve the goal of green housing that is adapted to the local climate and environment and leads to a reduction of energy consumption, [6] As a result, all these benefits support the research solution of using local materials in the future.

As a result of the finding of the case study housing part, we discover that the traditional courtyard plays a significant role in achieving suitable sustainable solutions for the local environment in terms of providing natural ventilation, cooling, heating and lighting. This finding was confirmed by users with experience of living in both traditional and contemporary types of housing. Furthermore, users confirmed the role of local materials in providing heating and cooling due to their characteristics of resisting climatic conditions (as stated by the users). The study findings in these types of housing are that (related to user`s answer and part of data analysis) the courtyard plays a significant role if the housing is built with local materials and supplied with air movement which comes from a second small court, as presented in all traditional case study housing. All these findings have successful solutions in providing sustainable housing, as presented in this chapter.

In the main hypothesis of “Possibility of the lessons learned from the past of traditional courtyard housing enough to achieve the goal of Passive house , ”the research found that if proposals of sustainable solutions of traditional housing are considered in designing future housing, it will help to reduce energy consumption, especially for cooling and heating needs. Moreover, the use of local materials will reduce the cost of a building as well as provide the building with the ability to resist harsh climatic conditions and enhance its heating and cooling systems. Additionally, the social needs for privacy and safety are taken into account in order to meet people`s needs, which prevents them from changing the state of the building, thereby saving their money from waste because of any modification (as was presented the questionnaire results).

Related to the economic factor of water and electricity, the case study area has a groundwater source, which in the ancient houses, was used due to the suitability of the water for drinking (as users said in case study housing two). Therefore, water will be supplied to the building in the traditional form of the well. Moreover, rainwater in winter will be saved and reused by small strategies for plant watering or housekeeping. Finally, for the main economic issue of living without electricity due to the civil war, users depended on generators to supply lighting at night. In this case, solving this problem sustainably without high energy consumption, the strategy will have a solution involving solar panels which face the south in order to supply electricity at low cost. In conclusion, all these traditional sustainable solutions for courtyard housing and the advanced sustainable strategies of solar panels will achieve the research goal of passive as an example of nearly-zero energy housing in hot humid regions.

## **5.2. Result**

The results are divided into two types: the questionnaire and the case study housing findings:

### **5.2.1. Result in the questionnaire part**

This study highlighted the problems associated with contemporary and traditional Libyan houses in hot humid regions. The environmental problems have been identified in relation to four important elements: natural ventilation, cooling, heating and lighting. Moreover, social problems were also addressed in terms of privacy and security. Finally, we identified the economic problems of water shortages. The methodology which was used to identify these problems was the questionnaire. This questionnaire was given to the sample of people living in the hot humid zone. The questions covered all the previous factors and the findings presented the housing problems that users face as:

1. Most houses are not warm in winter therefore, people are heating their spaces by means of electrical boilers (at an average of 75% in AP, 80% in TH and 75 % in DH).
2. The lack of cooling systems made people depend on electrical energy in summer time \ (90% of users in TH use air conditioning to cool their spaces, 60% in AP, and 80% in DH).
3. The lack of electricity made users dependent on small generators (at an average of 40% in TH, 97% in AP, 80% in DH).
4. The problem of privacy and safety resulted in people creating numerous solutions, such as high walls, covered windows and balconies (90% covered their windows in TH; these solutions were implemented at an average of 65% in AP and 55% in DH).

### **5.2.2. Results in case study housing part**

In this study, houses were analyzed for people living in traditional houses then moved to contemporary houses (thereby having the experience of living in two types of house). Through analysis of traditional houses, many important points were concluded with regard to systems of lighting, ventilation, cooling and heating in addition to other factors. The traditional houses were also compared with contemporary houses to identify the reasons for users having selected their particular answers.

In this section, the results are summarized as follows:

1. Traditional courtyard housing succeeded in creating a suitable environment in terms of natural lighting, ventilation, cooling and heating systems.
2. Owners of traditional courtyard houses like their houses, especially the environmental solutions of cooling, ventilation, heating and lighting (users knew the importance of the traditional courtyard house after they moved to a contemporary house).
3. The only obstacle to living in a traditional house was inability of the structure to add new floors.

4. Privacy, which the traditional courtyard house provides to women was good however there was no privacy between family members as users stated because the doors were opened opposite other rooms )
5. Safety is available in the traditional house if it has more than one floor (as users stated in Housing Case Study Two).
6. In conclusion, there are many successful environmental solutions that must be considered when designing passive house in the future.

### **5.2.3. Result of design guideline;**

#### **5.2.3.1. general guideline ;**

- As result of privacy needs, most window and balcony should be covered by Al mshrabea
- Due to issue of sun heat in summer time, windows and balcony are preferred to be covered with plants or wood roof.
- The open spaces of garden and roof should be covered by plant
- The roof of building and hall of the stairs in which face the sun are the best space for solar panel as illustrated
- The good location for plant and tree in south side to minimize sun heat.
- The covered courtyard is preferred due to the privacy need
- It is necessary to protect the windows from the southern wind with double glass, horizontal surface above windows and wood covered.
- Wide walls are required in the south and west side ( thermal mass )

#### **5.2.3.2. result guideline for design a model**

- For north façade ; in summer time allow the north winds to enter in the building rooms through;
  - a) Designing walls with small openings
  - b) Designing a courtyard in north of building
  - b) Designing windows and balconies in north faced more than other faced.
  - C) Minimize the obstacles that prevent the air to enter the building
  - d) Minimize the Trees and plants in north garden
  - f) The location of hall of the stairs should be in north of building by designing high roof to allow cold air to enter in the summer

- For south façade ; in winter the main solutions which should consider to make the rooms warm are ;
  - a) Good insulation (thermal mass) of walls windows and doors
  - b) The open spaces which located in north side do not need covers like south spaces
  - c) The rain direction which come from northwest is still the big problem for building in case study area, so the west and north faced need solutions more than another faced, , presented solution for this problem in aim to prevent the water to enter in the rooms such as; Double glass, horizontal surface above windows and slope the bottom of the window and minimize the size of window and balcony in west faced.

### 5.3.RECOMMENDATIONS

The study presents suitable solutions for future housing in hot humid climates. The proposed solutions will provide a comfortable indoor environment including suitable ventilation, lighting, cooling and heating, as illustrated in Chapter Four. The following are recommended:

**For users:** There are proposed solutions to enhance the privacy and safety which is needed the housing of users. They are easy to apply in the outdoor space. Moreover, people should assert these solutions to meet their needs in future homes.

**For specialists:** First, designers should take into account the proposed environmental solutions, which are appropriate to the local environment and people's needs. Second, these solutions will enhance designers' ability to design more sustainable solutions in future work.

**For the government:** The government must take into consideration the social, environmental and economic problems that users are facing in their contemporary houses because they follow foreign expertise in designing houses. This study will reduce the appearance of these problems in the future if the government takes into consideration these solutions in designing future housing.

**For future recommendation;** this work presents environmental and social solutions for housing, which are easy to apply because they are derived from traditional courtyard housing, and local environments. Therefore, the study proposes for future works that simulate this design to evaluate cooling, heating and natural ventilation as well as energy consumption. Additionally, a deeper study is needed for sustainable solutions that reduce electricity and water consumption.

## REFERENCES

1. Al Sayyed , W. (2011)"Contemporary Arab Architecture: Space, Form, and Function" Lonaard Magazine is a peer-reviewed periodical, publication of Lonaard Group in London Issue 7, Volume 2, January 2011, ISSN: 2045 – 8150
2. Al Sayyed , W. (2011). “ The Morphology Of The Traditional Arab House” Examining courtyard and non-courtyard prototypes" Lonaard Magazine is a peer-reviewed periodical, publication of Lonaard Group in London Issue 10, Volume 2, July 2012, ISSN: 2045 – 8150
3. Al-Zubaidi, M. (2002). The Efficiency of Thermal Performance of the Desert Buildings – The Traditional House of Ghadames / Libya. Annual Conference of the Canadian Society for Civil Engineering, Montréal, Québec, Canada 5-8 juin 2002 / June 5-8, 2002.
4. Al-Zubaidi, M. (2002) “Sustainability Principles of Traditional Architecture in the Islamic Perception”, Faculty of Engineering-University of Baghdad.
5. AL- mansuri. A. (2008).The Effects of Passive Design and Renewable Energy in Producing Low Energy Efficiency Architecture and Special Identity – (Case Study Libyan Desert Zone – Ghadames). Research Institute for the Built and Human Environment, University of Salford, Salford, Greater Manchester, M5 4WT, UK. Conference paper.
6. AL- mansuri, A. (2010) "Designing a Dwelling Unit in Tripoli -Libya by Using Sustainable Architectural Principles " Research, University of Salford, UK.
7. Aburounia, H. (2010)," The Internal Layout Design of Social Housing in Libya: a Cultural Value Perspective" paper in AI-Fatah University, Tripoli, Libya, 2010.
8. Al naser .N. (2008).Towards Sustainable Buildings in Bahrain, Kuwait and United Arab Emirates, The Open Construction and Building Technology Journal, 2008, 2, 30-45
9. Azzuz, I. (2000) "Contemporary Libyan Architecture: Possibilities vs. Realities"Libya

10. Azlitni, A. (2009). " The Libyan Architectural Features Between Traditional And Modernization ". Journal for Housing Science, Vol.33, No.3 pp. 137-148, 2009 Published in the United States.
11. Aburounia , H & Sexton , M." sustainability of housing layout design from a social – cultural perspective in libya “ . Research Institute for the Built and Human Environment University of Salford.
12. Anthony, K. (2011) . Arab Culture and Urban Form. California Polytechnic State University.
13. Aiman, A & Pugnaroni, F. (2014). Re-Thinking Traditional Arab Architecture: A Traditional Approach to Contemporary Living '. IACSIT International Journal of Engineering and Technology, Vol. 6, No. 4, August 2014
14. Abass, F & Hakim, L &Solla , M. ( 2016) .A Review Of Courtyard House : History Evolution Forms ,And Function Arpn Journal of Engineering and Applied Sciences. .University Tun Hussein Onn Malaysia, VOL. 11, NO. 4, FEBRUARY 2016.
15. Abufayed , A &Rghei,A .( 2005). Urban planning and architecture of the historic city of Ghadames, Libya: lessons from the past for cities of the future. Repairs and Maintenance of Heritage Architecture. AlFateh University, Tripoli, Libya. WIT Transactions on The Built Environment, Vol 83, © 2005 WIT Press www.witpress.com , ISSN 1743-3509 (on-line).
16. Afkhamiaghdam .M (2015) A Case Study of Masdar City,Purdue University
17. Bashir , R. (2005) "The Development of Physical and Urban Planning Systems in Libya Sustainability of Planning Projects" , Faculty of Engineering – University of Al-Fateh, World Congress on Housing Transforming Housing Environments through Design.
18. Behsh , B. (1988) .The Traditional Arabic House , Its Historical Roots . arkitektur, utlandsby88ande, LNTH.VOL,1,NO4
19. Basulto. D, (2009), King Abdullah University of Science and Technology / HOK, online published 30 September, 2009 <https://www.archdaily.com>
20. Buletti , N. (2011) .An analysis of Masdar City’s communication strategy Using speech act theory to go beyond the corporate façade. University of Friburg, Faculty of Science, Geosciences Department, Geography Unit.
21. Daneshpour , A & Embi,M. (2013 ) Methods of Research into Privacy in Housing. Faculty of Built Environment, University Teknologi Malaysia. International Journal of Modern Engineering Research (IJMER) www.ijmer.com Vol.3, Issue.2, March-April. 2013 pp-618-621.
22. Elwefati, N. ( 2007) . Bio-climatic Architectur In libya : Case Studies From Three Climatic Regions” degree of Master of Science in Building Science, Architecture Department, Middle East Technical University.
23. Erhorn, H., & Erhorn-Kluttig, H. (2014). Selected examples of nearly zero-energy buildings. Report of the Concerted Action EPBD.

24. Eltrapolsi , A. (2016).The Efficient Strategy of Passive Cooling Design in Desert Housing: A Case Study in Ghadames, Libya. The University of Sheffield.
25. EI Osta ( 2016) -Assessment of Groundwater Quality by Determining Water Quality Factor in Darnah Region - Libya Omar Al-Mukhtar University- Libya
26. El Hajj, M.(2015 ), “ Khalifa Mosque Trader in Dubai .. Environment friendly “ , Posted: Friday, June 26, 2015 , <http://www.alittihad.ae>
27. Falola, T. Morgan ,J (2011)..Culture and Customs of Libya; Housing And Architecture ; p72. Santa Barbara, California.
28. Gaurish Wagle , Team Leader. (2014) Masdar City: Planning a Sustainable, Smart City . Urban Planning, Masdar City Conference: Municipalika 2014 - 12th International Conference on emerging trends in Sustainable Habitat and Integrated Cities.
29. Gabril,N. (2014). Thermal Comfort and Building Design Strategies for Low Energy Houses in Libya Lessons from the vernacular architecture. A thesis submitted in partial fulfillment of requirements of the University of Westminster.
30. Helmi , M . “Spatial Planning in Libya; from an analogue product to a digital process ”, Janzour – Tripoli, Libya.
31. Hassan, F. (1965).Architecture for poor. Egypt.
32. Hassan, F. (1986) "Natural Energy and Vernacular Architecture: Principles and Examples with Reference to Hot Arid Climates " Egypt.
33. Ismail, R. (2015). Adaptation of Housing Design to Culture Change in Syria: Concepts and Practices in the City of Lattakia. Heriot-Watt University School of Energy, Geoscience, Infrastructure and Society.
34. Jacobson & Weber & Carmody (2009). DESIGN GUIDELINES FOR SUSTAINABLE HOUSING. Center for Sustainable Housing Yonsei University, South Korea.
35. James, S. (2005). Architecture of RasimBadran; Narratives on People and Place. Published August 12th 2005 by Thames & Hudson.
36. Jong-Jin, K. (1998). Sustainable Architecture Module: Introduction to Sustainable Design "
37. Mohamed, A. (2015)" Comparison of House Characteristics and Facilities In Libya and Indonesia”, University of Brawijaya, Malang, Indonesia Indonesian. IOSR Journal of Mechanical and Civil Engineering.
38. Mlecnik, E. (2011). Defining nearly zero-energy housing in Belgium and the Netherlands. OTB Research Institute for the Built Environment, Delft University of Technology
39. Mortada, H. (2003). Traditional Islamic Principles of Built Environment, Routledge Curzon, New York, USA.

40. Morton, E. (1990). "Courtyard Housing : A Solution Highdensity , Low –rise Single Family Housing In The US “.
41. Ragette, F . (2003).Traditional Domestic Architecture of the Arab Region, Axel Menges, Stuttgart.
42. Reardon, Ch. (2013). Passive-design, thermal-mass, P179. <http://www.yourhome.gov.au/passive-design/thermal-mass>.
43. Steinbock & The Weidt Group (2006). Zero Energy: Designing and Monitoring a Zero Energy Building that Works; The Science House in Minnesota. 2006 ACEEE Summer Study on Energy Efficiency in Buildings.
44. Sheibani, G. & Havard, T. (2005) .The government role in housing in libya during the period 1970 - 2000 . In: Khosrowshahi, F (Ed.), Proceedings 21st Annual ARCOM Conference, 7-9 September 2005, London, UK. Association of Researchers in Construction Management, Vol. 2, 697–707
45. Sasi, E. (2007) . “urban predicament in derna city ; past and present”. Istanbul , Turkyia .
46. Sasi, E. (2013) "the stages of development in Derna city". Bengazi ,Libya,
47. Sasi.Y. ( 2013) components and applications of wind turbines . Dar Al Fadil. Bengazi ,Libya,
48. SHAWESH,A. (1996). Housing design and socio-cultural values in libya: an investigation of tradtional and contemporary housing “ .School of Architecture University of Newcastle Upon Tyne, UK.
49. Staatsblad , B. (2002)..Moniteur Belge.
50. Peterson, K & Torcellini ,P & Grant, R. ( 2015). A Common Definition for Zero Energy Buildings. Prepared for the U.S. Department of Energy by The National Institute of Building Sciences.
51. Torcellini ,P & Pless , S & Deru, M. (2006 ) . Zero Energy Buildings: A Critical Look at the Definition. Conference Paper NREL/CP-550-39833 June 2006, National Renewable Energy Laboratory.
52. Tošković, D. (2006). Man – Environment Interaction : A review Of Modern Architecture Of Libya In Tranision .Journal: Spatium ISSN 1450-569X Volume: 2006; Issue: 13-14; Start page: 47; Date: 2006.
53. Tang, G. (2010 ) . Sustainable Architecture and Urban Development; Masdar - The Sustainable Desert City: A Theoretical Mirage or a Realistic Possibility? Sheffield Hallam University, UK. p175. Proceedings Conference of SAUD
54. Vincent Callebaut Architectures , Paris .(2017) The gate helopolis , Smart multi-use complex, Cairo 2014-2019, Egypt, [http://vincent.callebaut.org/object/141029\\_thegate/thegate/projects/user](http://vincent.callebaut.org/object/141029_thegate/thegate/projects/user)

55. Wagle , G. (2014). Global Sustainable Cities Network, Masdar – Building a Sustainable City. 22nd January 2014
56. Jong-Jin, K. (1998) . Sustainable Architecture Module: Introduction to Sustainable Design "
57. Waziry ,y. (2007). Architectural design eco-friendly. .Egypt
58. Waziry ,y.(2004) .Islamic architecture and environment . Egypt
59. Waziry ,y. (2002).Applications on Landscape Architecture. Egypt
60. NURA, S. (2011) "Using Traditional Materials for Designing Affordable Housing to Provide Green Buildings" European Journal of Social Sciences – Volume 20, Number 1 ,2011.

## APPENDIX (A)

### THE QUESTIONNAIRE

This questionnaire will be the part of our PHD thesis which named passive housing in hot, humid climate ". This question presented the main problems which people has faced in daily life in their housing and the advantages of living there. Also, presented same questions about people needs for future housing in Libya a specially in the hot, humid climate, so please answer these questions and put the sign in the appropriate box, also be sure not to miss any answers because your answers will be a part of our result in this thesis.

**Please put the sign (☐) in the appropriate box:**

**General Information:**

**-Your City: ....**

**-Gender.....**

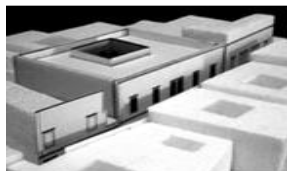
- Male
- Female

**-The age ....**

- 20-30
- 31-40
- 41-50
- Over 50

**-Where do you live ....**

- In traditional housing ..... (figure 1)
- In contemporary housing..... (figure 2)
- Apartment ..... (figure 3)



(Figure 1)



(Figure 2)



(Figure 3)

**Ownership.....**

- Owner

- Renter
- Live with my original family

**You are now;**

- Live in Libya
- Live in Turkey

**How long have you been living in this house/apartment;**

- Less than five years
- Between 5 and 10
- Between 10 and 20
- Between 20 and 30
- More than 30

**The floor high is.**

- 3 m
- 4 m
- More than 4 m

**-How many families are living in the same house /apartment:**

- One family
- Two families
- Over two families

**Lighting**

**A. What kind of window do you have?**

- Glass windows only ..... (figure 1)
- Glass windows with interior curtains.....(figure 2)
- Glass windows with an external packaging..... (figure 3)
- Glass windows with an external packaging and internal curtains..... (figure 4)



(Figure 1)



(Figure 2)



(Figure 3)



(Figure 4)

**B. What is the size of the window openings (mostly) on the street**

**Large window means;** proximity up 50% of the Facades

**Mid-size window means:** proximity 40-30 % of the Facades

**Small window means:** proximity 30-10 % of the Facades

- Large windows ..... (figure 1)
- Mid-size windows..... (figure 2)
- Small windows.....(figure 3)



L.W (Figure 1)M.W (figure 2)

S.W (Figure 3)

**C. Do you use natural lighting during the day?**

- Yes, I use natural lighting. .... (figure 1)
- No, I use artificial lighting..... (figure 2)
- Both..... (figure 1)



(Figure 1) (Figure 2)

(Figure 3)

**D. If the answer is yes, what is the way of lighting your indoor spaces**

- I use window lighting ..... (figure 1)
- I use the courtyard lighting)..... (figure 2)
- Both ..... (figure 3)



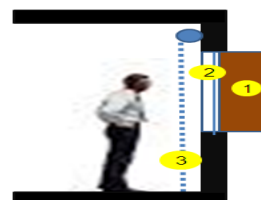
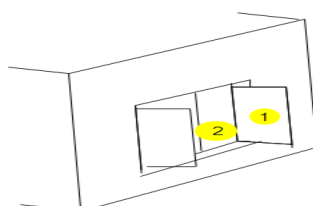
(Figure 1)

(Figure 2)

(Figure 3)

**E. If you open the window, what kind of window do you open**

- I open the glasses window only (2)
- I open the screen window only (1)
- I open both with the interior curtains (1), (2), (3)



**F. If you do not open windows, so answer why don't open windows**

- Losing the Privacy
- Artificial lighting not expensive
- Because of dust and noise

**G. Level of natural lighting**

- V- good
- Good
- Acceptable
- Bad
- V-bad

**Cooling**

**H. How do you cooling your spaces in the summer?**

- Naturally..... (figure 1)
- Electrical fan..... (figure 2)
- Air conditioning..... (figure 3)
- Spaces do not need to be cooling because they are cooling



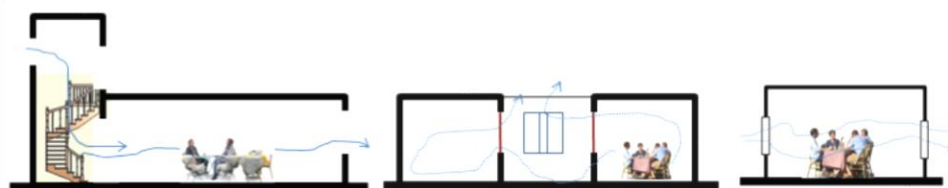
(Figure 1)

(Figure 2)

(Figure 3)

**I. If the answer is naturally, how?**

- By windows
- By courtyard
- By Vacuum of the stairs
- By roof halls



(Figure 1)

(Figure 2)

(Figure 3)

**J. Level of natural cooling**

- V- good
- Good
- Acceptable
- Bad
- V-bad

## Heating

### K. How do you heating your spaces in the winter?

- Electrical boilers..... (figure 1)
- Air conditioning ..... (figure 2)
- Stove..... (figure 3)
- I don't need because the spaces are warm



(Figure 1)



(Figure 2)



(Figure 3)

### L. Level of heating

- V- good
- Good
- Acceptable
- Bad
- V-bad

## Ventilations

### M. What kind of ventilation do you use in your spaces

- Natural ventilation ..... (figure 1)
- Artificial ventilation..... (figure 2)

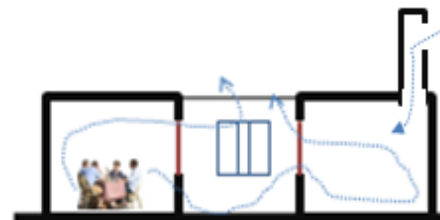


### N. How do your ventilation your spaces?

- By windows ..... (figure 1)
- By courtyard ..... (figure 2)
- By vacuum of the stairs..... (figure 3)
- By roof halls ..... (figure 4)



(Figure 1)



(Figure 2)



(Figure 3)

(Figure)

**O. Which floor has better ventilation**

- Ground floor
- First floor
- Second floor
- No different



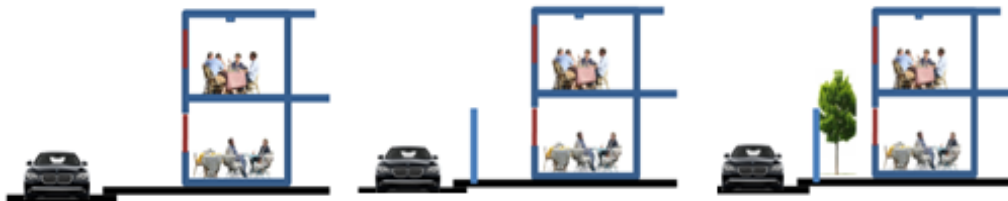
**P. Level of natural ventilation**

- V- good
- Good
- Acceptable
- Bad
- V-bad

**Privacy**

**Q. Which of these patterns do you have?**

- Housing without fence.....
- Housing with high fence.....
- Housing with plants and a fence...



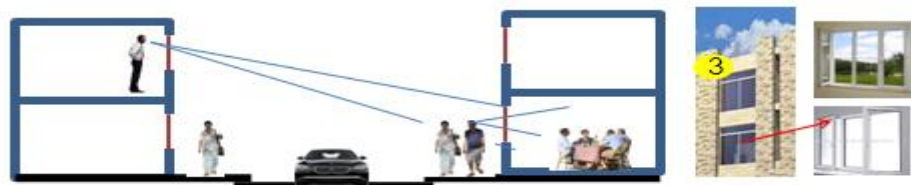
(Figure 1)

(Figure 2)

(Figure 3)

**R. Which of these designs exist in your home.....?**

- Windows that obscure the vision (1)
- Wall that obscures the vision (2)
- Both.... (1), (2)
- Large windows and glass which not obscure vision.... (3)
- Glass windows (3) and fence which obscures the vision (2)



**S. If you are closing the window during the day; What is the reason for closing the windows during the day**

- you don't like to be seen by neighbors (1)
- you are not interested to the natural lighting (2)
- both
- you prefer to close windows without reason



**T. What do you prefer about visitor's spaces...**

- Separation between women spaces and men spaces
- No Separation

**U. Do you combine the external balconies to the interior space?**

- Yes ..... (figure 1)
- No..... (figure 2)



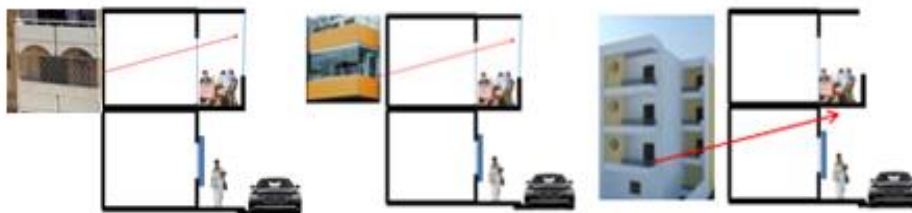
(Figure 1) (Figure 2)

**V. If yes, why did you combine the external balconies to the interior space**

- because the interior spaces are small
- Because of neighbors

**W. If the answer is no, how t did you deal with the space of the balcony**

- left uncovered
- it is covered by with a glass
- it is covered with iron Protection



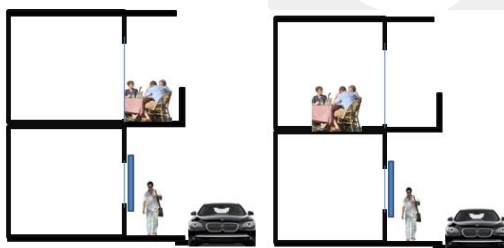
(Figure 1)

(Figure 2)

(Figure 3)

**X. Do you sit with your family in the balcony?**

- Yes
- No



**Y. Level of Privacy**

- V- good
- Good
- Acceptable
- Bad
- V-bad

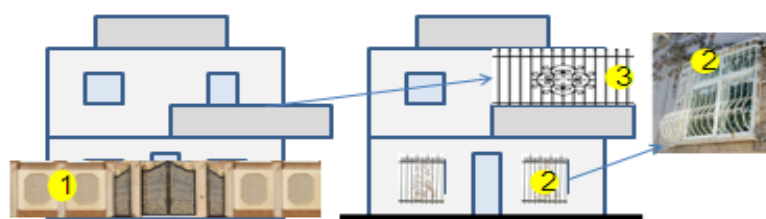
## Safety

### Z. Would you prefer to live ...?

- Live near relatives
- No different because the city is safe

### AA. How do you achieve safety goal at your house?

- By High fence ..... (1)
- By Closed balcony..... (3)
- By Closed windows..... (2)
- All above
- Safety not important for me



### BB. Level of safety

- V- good
- Good
- Acceptable
- Bad
- V-bad

## cost of building

### CC. Do your housing faced characteristics.

- Completed
- Incomplete

### DD. What is the reason of incomplete housing

- The High cost of **building** facades
- Owner change the original plan which cost more
- Add new floor

### EE. After the construction, your housing or after moving to apartment, did you made modifications inside and outside the building

- yes
- no

### FF. How many times did you do modifications

- once
- twice
- more than twice

**GG. What kind of modification did you make**

- changing Room Size
- Opening window on street
- Changing window size
- Cover the courtyard
- Build new floor
- Using new materials to cover the facades
- All above

**HH. If the answer is yes, why you have made these modifications inside and outside the building**

- the housing does not achieve the people's social needs
- for more wide spaces
- Lack of privacy, safety
- People like to change without reason

**The cost of Water and Electricity**

**Electricity**

---

**II. How much the cost of the electricity bill**

- I don't pay for it
- Inexpensive
- Expensive

**JJ. Wasthe electricity available before-2011**

- yes
- no

**KK. Is the electricity available now?**

- yes
- no
- Sometimes available
- mostly available

**LL.If the answer is no or sometimes, how do you do to lighting your house at night?**

- Motorhome electricity..... (figure 1)
- By traditional ways.....(figure 2)
- Bulbs charged with electricity..... (figure 3)



(Figure 1)



(Figure 2)



(Figure 3)

**MM. What is your satisfaction with the level of electricity in your city**

- V- good
- Good
- Acceptable
- Bad
- V-bad

**Water**

**NN. Do you pay the bill to the government for water?**

- Yes
- No

**OO. Does the water available before 2011**

- Yes
- No

**PP. Does the water available now?**

- Yes
- No

**QQ. How do you get the water?**

- I Buy the water
- I have Well

**RR. What is your satisfaction for the water in your house**

- V- good
- Good
- Acceptable
- Bad
- V-bad

**SS. After your experience of living in your house or apartment, what do feel about your house;**

- I feel comfortable
- I don't feel comfortable

**TT. Where do you prefer to live .....**?

- Apartment ..... (figure 1)
- Modern housing..... (figure 2)
- Traditional housing..... (figure 3)



(Figure 1)



(Figure 2)



(Figure 3)

**UU. What is the most important element in the designing a house**

- Safety
- Privacy
- Achieves comfortable indoor environment (cooling, heating ,ventilation)
- Low cost

**VV. What the big problem for living in contrary housing / traditional housing for you ...**

- Function problems
- Social problems
- Economic problems
- Environmental problems

**WW. Do you prefer to live in a house with**

- Artificial conditioning, lighting, ventilation
- Natural **conditioning**, lighting ,ventilation

**XX. Do you prefer a house with Courtyard?**

- Yes ..... (figure 1)
- No
- I prefer external garden surrounded by high fence..... (figure 2)
- I prefer external garden surrounded by a lowfence..... (figure 3)
- I do not any



(Figure 1)



(Figure 2)



(Figure 3)

**YY. If the answer is yes, what is the benefit of courtyard ....**

- Has environmental benefit
- Has social benefit
- Has traditional value
- I prefer without reason

**ZZ.If the answer is no, why do you not prefer to live in house with Courtyard**

- Because of the vision of neighbor
- Due to exposure to rain and dust
- I do not feel the importance of it

*Thank you for answering the questions*

## APPENDIX (B)

### Arabic Questionnaire

يعد هذا الاستبيان جزء من متطلبات رسالة الدكتوراه في دراسة خاصة تعتنى بالمشاكل البيئية للمسكن الليبي بأنواعه الثلاثة ، لذا تتطلب هذه الدراسة التعرف على آراء السكان حول قضايا أهمها :

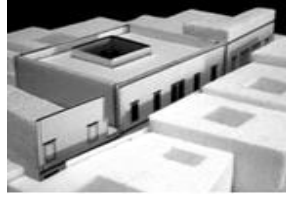
- مميزات و عيوب النظم البيئية لكل من : الإضاءة الطبيعية ، التهوية الطبيعية ، التبريد الطبيعي و التدفئة .
  - المشاكل الاجتماعية (الخصوصية والأمان ) والمشاكل الاقتصادية ( التكلفة و مشكلة الكهرباء و الماء ) التي تواجه السكان في دورة حياة المبني.
  - الرغبات المستقبلية للسكان للمسكن الليبي في المستقبل .
- لذا نرجوا منكم الإجابة مشكورين على هذه الأسئلة مع التأكد من عدم ترك إجابات فارغة ، لان إجاباتكم سوف تكون جزء من نتائج هذه الرسالة .

ملاحظة : اجب عن الأسئلة للفترة ما بين 1990 – 2011

المدينة	.....	الجنس:	رجل ○ أنثى ○	حالة الملكية :	مالك ○ مستأجر ○ مع الأهل ○
عدد الأسر التي تعيش في نفس الفيلا أو البيت :	○ أسرة - واحدة ○ أسرتين ○ أكثر ○ أسرتين	اسكن في الطابق :	○ الأرضي ○ الأول ○ الثاني ○ الثالث	ارتفاع سقف المسكن :	○ 3 متر ○ 4 متر ○ .....

نوع السكن :

- فيلا سكنيه.... شكل (1)
- شقه سكنية مع الأهلشقه في عمارة سكنية.....شكل (2)
- بيت تقليدي في المدينة القديمة.....شكل (3)



شكل (3)



شكل (2)



شكل (1)

1. هل تستخدم الإضاءة الطبيعية خلال النهار... (قبل مشكلة انقطاع الكهرباء)

- نعم ، استخدم الإضاءة الطبيعية .... شكل (1)
- لا ، استخدم الإضاءة الصناعية بدل عنها.....شكل (2)
- كلاهما .....شكل (3)



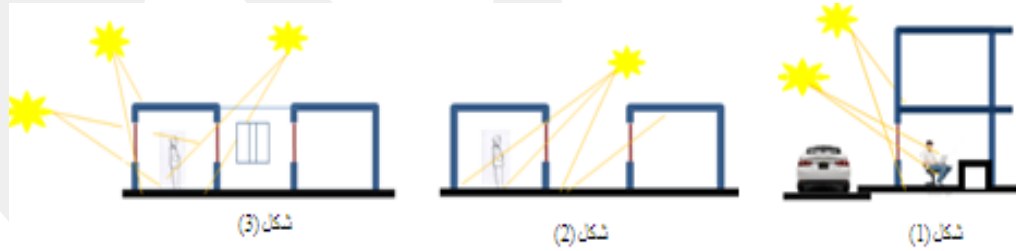
شكل (3)

شكل (2)

شكل (1)

2. إذا كانت الإجابة نعم أو في الغالب تستخدم الإضاءة الطبيعية ، فكيف تتحصل على الإضاءة الطبيعية....

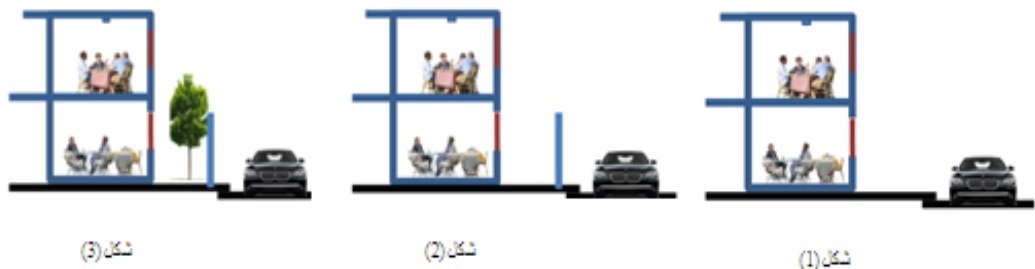
- الإضاءة عن طريق النوافذ المطلة على الشارع ..... شكل (1)
- الإضاءة عن طريق الفناء الوسطي..... شكل (2)
- الإضاءة عن طريق النوافذ المطلة على الشارع و الفناء الوسطي..... شكل (3)
- أجابه أخرى .....



شكل (3)

شكل (2)

شكل (1)



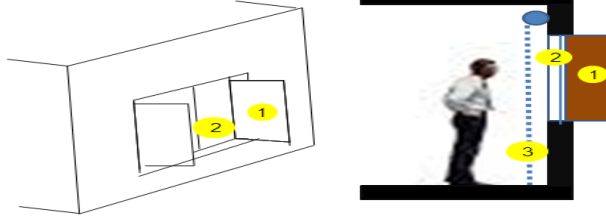
شكل (3)

شكل (2)

شكل (1)

3. إذا كنت تفتح النوافذ على الشارع نهار ، أي نوع من النوافذ تفتح .....

- الزجاج .....2
- البارسيان .....1
- الزجاج و البارسيان و الستائر .....1و2و3
- أجابه أخرى .....



(1) غلاف خارجي للنافذة ( البرسيان ) (2) الزجاج (3) الستائر الداخلية

4. إذا كانت الإجابة لا، لماذا لا تستخدم الإضاءة الطبيعية في النهار .....

- افقد الخصوصية ( أكون مشاهد من قبل المارة والجيران )
- لا احتاج للإضاءة الطبيعية لان الإضاءة الصناعية لا تكلف ماديا
- لا افتح النوافذ منعا للأتربة والضوضاء نهارا
- أجابه أخرى .....

5. ما هو مستوى الإضاءة الطبيعية نهارا

- ممتاز
- جيد
- سئ

## التبريد

التبريد: هو خفض درجة حرارة الفراغات الداخلية ولا يشترط تهويتها.

6. كيف يتم تبريد الفضاءات الداخلية في فصل الصيف .....

- استخدام النوافذ وأساليب أخرى طبيعية ..شكل (1)
- استخدام المراوح الكهربائية ..شكل (2)
- التكييف الصناعي ( المكيف ) ..شكل (3)
- لا تحتاج الفضاءات إلي التبريد ، لأنها مبردة نسبيا
- طرق أخرى .....



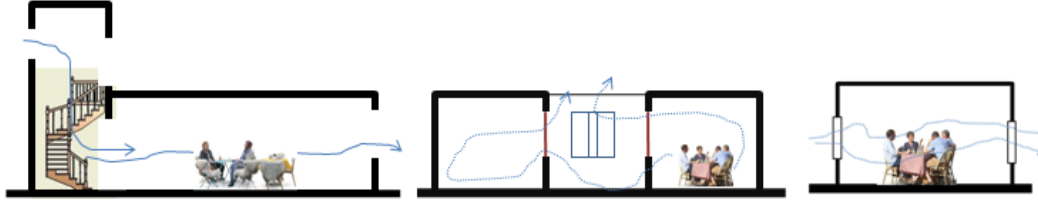
شكل (3)

شكل (2)

شكل (1)

7. إذا كنت تستخدم التبريد الطبيعي أيهما أكثر نفعا ....

- التبريد بفتح النوافذ....شكل (1)
- التبريد بالفناء الداخلي...شكل (2)
- التبريد بالتهوية عن طريق فراغ السلالم... شكل (3)
- التبريد بطرق أخرى .....،.....



شكل (3)

شكل (2)

شكل (1)

8. ما هو مستوى التبريد الطبيعي.....

- ممتاز
- جيد
- سيئ

## التدفئة

9. كيف يتم تدفئة الفضاءات الداخلية في الشتاء.....

- بواسطة المدفئة....شكل (1)
- بواسطة المكيف ...شكل (2)
- بواسطة إشعال الفحم أو النار... شكل (3)
- الفضاء لا يحتاج إلي تدفئة ، فهو دافئ نسبيا



شكل (3)

شكل (2)

شكل (1)

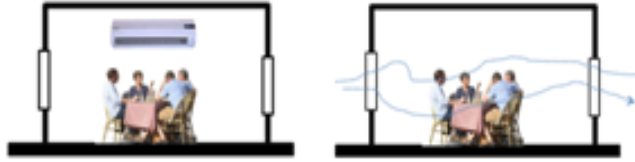
10. مستوى التدفئة في فصل الشتاء يعتبر.....

- ممتاز
- جيد
- سيئ

التهوية الطبيعية : دخول هواء صحي إلى الفضاءات الداخلية

11. ما نوع التهوية التي تستخدمها في منزلك أو شقتك ..... (قبل مشكلة انقطاع الكهرباء )

- تهويه طبيعية ....شكل (1)  
 تهوية صناعية ...شكل (2)



شكل (2)

شكل (1)

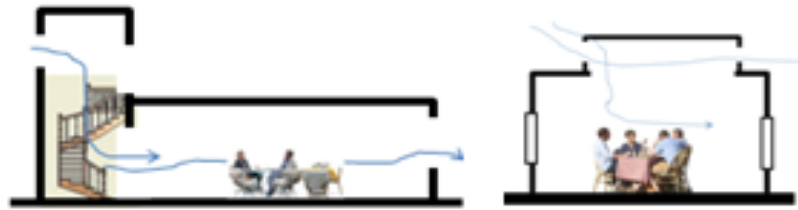
12. إذا كانت التهوية طبيعية ، كيف يتم ذلك .....

- التهوية عن طريق النوافذ....شكل (1)  
 التهوية عن طريق الفناء الداخلي ...شكل (2)  
 التهوية عن طريق السقف .... شكل (3)  
 التهوية عن طريق فراغ السلالم ... شكل (4)  
 طرق أخرى .....



شكل (2)

شكل (1)



شكل (4)

شكل (3)

13. إذا كنت تسكن في أكثر من طابق اجب .....أي الطوابق لديها تهويه أفضل.....

- الطابق الأرضي ....شكل (1)  
 الطابق الأول  
 الطابق الثاني  
 الطابق .....  
 لا اختلاف بينها



14. شكل (1)

15. مستوى التهوية الطبيعية.....

- ممتاز  
 جيد  
 سيئ

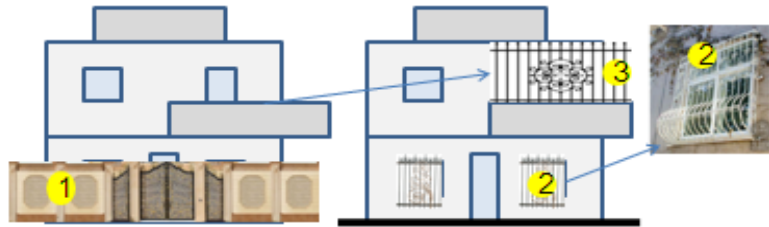
### الأمان

16. هل تفضل السكن بالقرب من عائلتك الأصلية للشعور بالأمان ..... (اجب للفترة قبل 2011 )

- نعم  
 لا ، لان المدينة أمنه نسبيا  
 لا يوجد فرق

17. كيف تحقق الأمان في بيتك أو شقتك السكنية

- إحاطة المبنى بسور عالي ..... شكل (1)  
 حماية النوافذ..... شكل (2)  
 حماية الشرفات ..... شكل (3)  
 كل ما ذكر  
 لا استخدم أي وسائل حماية  
 أجابه أخرى .....



18. مستوى الحماية .....

- ممتاز  
 جيد  
 سيئ

أي نوع من النوافذ تمتلك .....

- نوافذ زجاجية فقط.....شكل (1)
- نوافذ زجاجيه مع ستائر داخلية تحجب الرؤية
- ستائر داخلية..... شكل (2)
- ستائر داخلية مع ستائر داخلية تحجب الرؤية
- نوافذ زجاجيه مع تغليف خارجي ..... شكل (3)
- نوافذ زجاجيه مع تغليف خارجي و ستائر داخلية .....شكل (4)



شكل (1) شكل (2) شكل (3) شكل (4)

ما هو حجم فتحات النوافذ (الغالب) المطلة على الشارع في مسكنك .....

- نوافذ كبيرة .....شكل (1)
- نوافذ متوسطة الحجم ..... شكل (2)
- نوافذ صغيرة ..... شكل (3)

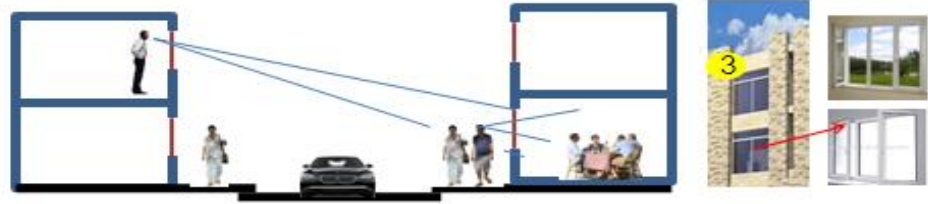


شكل (1) شكل (2) شكل (3)

19. ايهما تمثل نوافذ بيتك .....

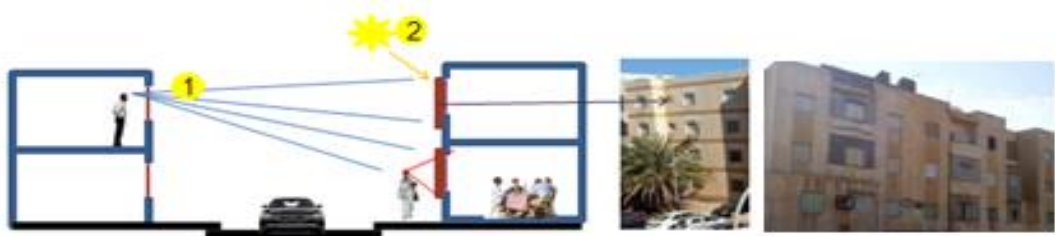
- شكل (1) تمثل نوافذ تحجب الرؤية
- شكل (2) تمثل سور يحجب الرؤية
- شكل (1) و (2) كلاهما
- شكل (3) تمثل نوافذ واسعة وزجاجية لا تحجب الرؤية
- شكل (3) و شكل (2) تمثل نوافذ زجاجية وسور يحجب الرؤية





20. ما سبب غلق النوافذ أثناء النهار

- لا تفضل أن تكون فراغاتك الداخلية مكشوف للجيران ....شكل (1)
- لا تفضل ضوء النهار (2)
- كلاهما
- لا يوجد سبب لذلك
- أجابه أخرى .....



21. ماذا تفضل بخصوص فضاء الضيوف ....

- فصل بين فضاءات الرجال والنساء
- لا أهمية للفصل
- أجابه أخرى .....

22. هل ضمنت الشرفات الخارجية للفضاء الداخلي أم لا

- نعم .....شكل (1)
- لا .....شكل (2)



شكل (2)

شكل (1)

23. إذا كان الجواب نعم ، فلماذا تم ضم الشرفة للفضاء الداخلي

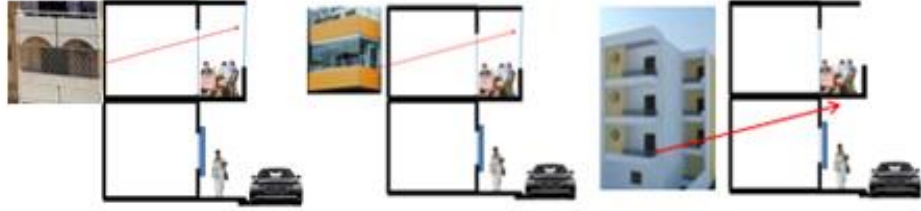
- لان المساحات الداخلية ضيقه
- حتى لا يكون مكشوف لرؤية الناس
- إجابة أخرى .....

24. إذا كان الجواب لا ،كيف تعاملت مع فضاء الشرفة

- ترك مكشوف .....شكل (1)
- تم تغليفه بالزجاج .....شكل (2)

□ تم تغليفه بحديد حماية .... شكل (3)

□ أجابه أخرى.....



شكل (3)

شكل (2)

شكل (1)

25. هل تجلس أنت وعائلتك في الشرفة الخارجية

□ نادرا

□ أحيانا

□ في الغالب

□ لا



26. ما هو تقديرك لمستوى الخصوصية في بيتك

□ ممتاز

□ جيد

□ سيء

### تكلفة المسكن

27. هل الواجهات الخارجية للمنزل مشطوبة

□ نعم

□ لا

28. إذا كانت الإجابة لا ، فما السبب في عدم إنهاء الواجهات بمواد الإنهاء

□ التكلفة العالية لإنهاء الواجهات

□ تغيير المخطط الاصلى حسب رغبة المالك أدى إلى رفع التكلفة ( إضافات أخرى لم تكن في

الخريطة الأصلية )

□ إضافة طابق جديد لم يكن بالخريطة الأصلية

□ إجابة أخرى .....

29. بعد السكن ، هل قمت بتعديلات في الفضاءات الداخلية

- نعم  
 لا

30. كم مرة قمت بالتعديلات

- مرة  
 مرتين  
 أكثر من مرتين

31. ما هي نوع التعديلات

- تغيير في حجم الفضاءات الداخلية  
 غلق الفناء الداخلي  
 بناء طابق جديد  
 فتح النوافذ على الطريق  
 تغليف الواجهات الخارجي أو فقط تعديلها  
 إجابة أخرى .....

32. لماذا قمت بهذه التعديلات ....

- بغرض التوسيع لبعض الفراغات الداخلية  
 بسبب نقص الخصوصية ( غلق بعض الفتحات المكشوفة رؤية الجيران )  
 الفضاءات الداخلية وتقسيماتها لا ترضي الساكنين  
 بدون سبب لمجرد التغيير  
 إجابة أخرى .....

## الكهرباء

33. ما هي تكلفة فاتورة الكهرباء شهريا ( اجب للفترة قبل 2011 )

- عالية  
 غير عالية  
 لا ادفع فاتورة للكهرباء

34. هل كان الكهرباء متوفر قبل 2011

- نعم  
 لا

35. هل الكهرباء متوفر الآن

- نعم  
 في الغالب نعم  
 في الغالب لا  
 لا

36. إذا كانت الإجابة لا أو في الغالب لا ، كيف تضيء بيتك ليلا

- استخدم ماتور كهربائي ..... شكل (1)
- استخدم الطرق التقليدية في إضاءة البيت ( الشموع وغيرها ) شكل (2)
- الألواح الشمسية .....شكل (3)
- طرق أخرى .....



شكل (3)



شكل (2)



شكل (1)

**ملاحظة:** إذا كنت لا تعلم بسبب كونك خارج ليبيا، تكلم عن اهلك المقربين

37. ما هي درجة رضائك عن مستوى الكهرباء في مدينتك الآن

- ممتاز
- جيد
- سيء

## الماء

هل تدفع فواتير لاستهلاك ماء قبل 2011

- نعم
- لا

38. هل الماء متوفر قبل 2011

- نعم
- لا

39. هل الماء متوفر الآن

- نعم
- لا

40. إذا كانت الإجابة لا ، كيف تتحصل على الماء

- اشترى الماء
- امتلك بئر ماء
- إجابة أخرى .....

41. ما هي درجة رضائك عن توفر المياه في بيتك الآن

- ممتاز
- جيد
- سيء

### رغبات الناس حول المسكن المستقبلي

42. أين تفضل السكن في مستقلا لو خيرت .....

- شقه سكنية ... شكل (1)
- فيلا حديثة.... شكل (2)
- بيت تقليدي بفناء داخلي .... شكل (3)



شكل

(3)



شكل (2)



شكل (1)

43. ما هو أهم عنصران عند تصميمك بيتك المستقبلي

- توفير الأمان
- الخصوصية الداخلية والخارجية
- التهوية والإضاءة الجيدة
- التبريد والتدفئة الجيدة
- التكلفة المنخفضة مع جودة مواد الإنشاء
- التصميم الوظيفي الجيد
- عنصر آخر .....

44. ما هي أهم مشكلة تود عدم تكرارها في بيتك المستقبلي ( يمكن اختيار أكثر من عنصر )

- المشكلة الوظيفية ( تقسيم وتوزيع الوظائف الداخلية )
- المشكلة الاجتماعية في عدم توفر الأمان والخصوصية
- التكلفة العالية للإنشاء أو عدم الحاجة للتعديلات المكلفة
- حل مشاكل التهوية والإضاءة طبيعيا
- حل مشاكل التبريد والتدفئة طبيعيا
- حل مشكلة عدم توفر الماء والكهرباء (توفيرها بطرق أخرى )

45. هل تفضل أن يكون بيتك المستقبلي مزود ب.....

- مكيف كهربائي للتبريد والتدفئة
- تكييف طبيعي للتبريد والتدفئة ( يتحقق ذلك بالتصميم الهيكلي للمبنى بحيث لا تحتاج إلي التكييف الصناعي

46. هل تفضل أن يكون بيتك المستقبلي مزود بفناء داخلي يتوسط المنزل وتفتح عليه اغلب الفضاءات الداخلية

- نعم  
 لا  
 لا اعرف



#### الفناء الداخلي

47. إذا كانت الإجابة نعم ، فلماذا تفضل السكن مع فناء داخلي

- يوفر إضاءة وتهويه جيدة ....الخ  
 مكان مناسب لاجتماع العائلة بعيدا عن أنظار الناس  
 إحياء لقيمته التراثية والجمالية  
 كل ما سبق  
 أفضله مع عدم وجود سبب لذلك  
 جواب آخر .....

48. إذا كانت الإجابة لا لماذا لا تحتاج إلى فناء داخلي

- لأنه سوف يكون مكشوف للمباني العالية  
 لأنه مكشوف للغبار والإمطار  
 لان لا أجد أهميه لتوفره بالبيت  
 إجابة أخرى .....









شكر لكم لتعاونكم معنا




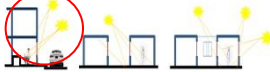



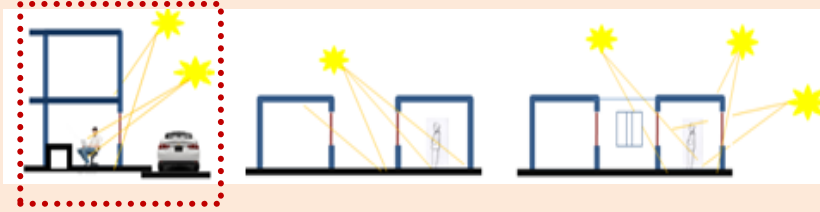
**APPENDIX (C) ;**  
**QUESTION ANALYSES**

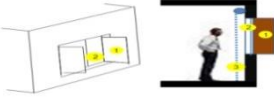

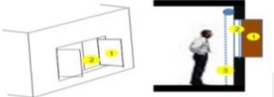

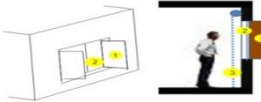
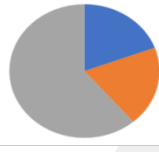
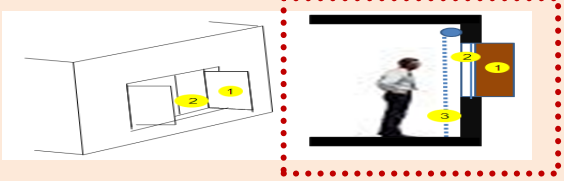
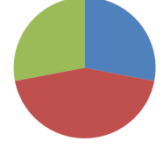


Q	Question	The Result of traditional housing Number of responses; 26	The Result of apartments Number of responses;56	The Result of Detached houseNumber of responses; 32
	General information	<p>Gender;</p> <ul style="list-style-type: none"> <li><input type="checkbox"/> Male; 15</li> <li><input type="checkbox"/> Female ;11</li> </ul> <p>Ownership;</p> <ul style="list-style-type: none"> <li><input type="checkbox"/> Owner; 13</li> <li><input type="checkbox"/> Renter; 1</li> <li><input type="checkbox"/> Live with my original family ;12</li> </ul> <p>You are now;</p> <ul style="list-style-type: none"> <li><input type="checkbox"/> Live in Libya; 5</li> <li><input type="checkbox"/> Live in Turkey; 7</li> </ul> <p>Note; <i>For 14 responses, there no answer.</i></p> <p>How long have you been living in thishouse/apartment;</p> <ul style="list-style-type: none"> <li><input type="checkbox"/> Less than five years; 2</li> <li><input type="checkbox"/> Between 5 and 10;5</li> <li><input type="checkbox"/> Between 10 and 20;2</li> <li><input type="checkbox"/> Between 20 and 30;1</li> <li><input type="checkbox"/> More than 30;1</li> </ul> <p>The floor high is.</p> <ul style="list-style-type: none"> <li><input type="checkbox"/> 3 m;21</li> <li><input type="checkbox"/> 4 m;3</li> <li><input type="checkbox"/> More than 4 m</li> </ul> <p style="text-align: center;">-</p>	<p>Gender;</p> <ul style="list-style-type: none"> <li><input type="checkbox"/> Male; 24</li> <li><input type="checkbox"/> Female; 32</li> </ul> <p>Ownership;</p> <ul style="list-style-type: none"> <li><input type="checkbox"/> Owner; 36</li> <li><input type="checkbox"/> Renter;9</li> <li><input type="checkbox"/> Live with my original family; 11</li> </ul> <p>You are now;</p> <ul style="list-style-type: none"> <li><input type="checkbox"/> Live in Libya; 30</li> <li><input type="checkbox"/> Live in Turkey ;26</li> </ul> <p>How long have you been living in this house/apartment;</p> <ul style="list-style-type: none"> <li><input type="checkbox"/> Less than five years; 24</li> <li><input type="checkbox"/> Between 5 and 10;10</li> <li><input type="checkbox"/> Between 10 and 20;8</li> <li><input type="checkbox"/> Between 20 and 30;10</li> <li><input type="checkbox"/> More than 30;4</li> </ul> <p>The floor high is.</p> <ul style="list-style-type: none"> <li><input type="checkbox"/> 3 m;15</li> <li><input type="checkbox"/> 4 m;6</li> <li><input type="checkbox"/> More than 4 m</li> </ul> <p style="text-align: center;">-</p>	<p>ender;</p> <ul style="list-style-type: none"> <li><input type="checkbox"/> Male; 19</li> <li><input type="checkbox"/> Female; 13</li> </ul> <p>Ownership;</p> <ul style="list-style-type: none"> <li><input type="checkbox"/> Owner; 21</li> <li><input type="checkbox"/> Renter; 0</li> <li><input type="checkbox"/> Live with my original family; 11</li> </ul> <p>You are now;</p> <ul style="list-style-type: none"> <li><input type="checkbox"/> Live in Libya; 12</li> <li><input type="checkbox"/> Live in Turkey; 19</li> </ul> <p>How long have you been living in this house/apartment;</p> <ul style="list-style-type: none"> <li><input type="checkbox"/> Less than five years;4</li> <li><input type="checkbox"/> Between 5 and 10;11</li> <li><input type="checkbox"/> Between 10 and 20;10</li> <li><input type="checkbox"/> Between 20 and 30;4</li> <li><input type="checkbox"/> More than 30;3</li> </ul> <p>The floor high is.</p> <ul style="list-style-type: none"> <li><input type="checkbox"/> 3 m;15</li> <li><input type="checkbox"/> 4 m;6</li> <li><input type="checkbox"/> More than 4 m</li> </ul> <p style="text-align: center;">-</p>

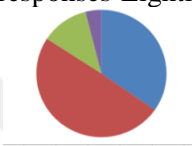
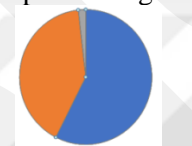


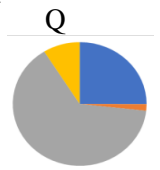

		<p>How many families are living in the same house /apartment:</p> <ul style="list-style-type: none"> <li><input type="checkbox"/> One family ;19</li> <li><input type="checkbox"/> Two families;4</li> <li><input type="checkbox"/> Over two families;3</li> </ul>	<p>How many families are living in the same house /apartment:</p> <ul style="list-style-type: none"> <li><input type="checkbox"/> One family;51</li> <li><input type="checkbox"/> Two families;1</li> <li><input type="checkbox"/> Over two families;3</li> </ul> <p>Which floor do you live in;</p> <ul style="list-style-type: none"> <li><input type="checkbox"/> Ground floor;12</li> <li><input type="checkbox"/> First floor;15</li> <li><input type="checkbox"/> Second floor;9</li> <li><input type="checkbox"/> Third floor;7</li> </ul>	<p>How many families are living in the same house /apartment:</p> <ul style="list-style-type: none"> <li><input type="checkbox"/> One family;22</li> <li><input type="checkbox"/> Two families;3</li> <li><input type="checkbox"/> Over two families;7</li> </ul> <p>Which floor do you live in;</p> <ul style="list-style-type: none"> <li><input type="checkbox"/> Ground floor;19</li> <li><input type="checkbox"/> First floor;5</li> <li><input type="checkbox"/> Second floor;5</li> <li><input type="checkbox"/> Third floor;3</li> <li><input type="checkbox"/> More than;0</li> </ul>
--	--	--	---	--

Q.1	<p>What kind of window do you have?</p> <ul style="list-style-type: none"> <li><span style="color: blue;">●</span> Glass windows only) ;<u>624%</u></li> <li><span style="color: purple;">●</span> Glass windows with interior curtains..... ;<u>5 20%</u></li> <li><span style="color: green;">●</span> glass windows with an external packaging;<u>728 %</u></li> <li><span style="color: orange;">●</span> glass windows with an external packaging and internal curtains ;<u>7 28%</u></li> <li>No answer =1</li> </ul> <p>18 Responses-Lighting -</p>	<ul style="list-style-type: none"> <li><span style="color: blue;">●</span> Glass windows only);7(14%)</li> <li><span style="color: orange;">●</span> Glass windows with interior curtains.....;15 (31%)</li> <li><span style="color: grey;">●</span> Glass windows with an external packaging; 9(18%)</li> <li><span style="color: yellow;">●</span> Glass windows with an external packaging and internal curtains;17(35%)</li> </ul> <p>48 Responses-Lighting -Q</p>	<ul style="list-style-type: none"> <li><span style="color: blue;">●</span> Glass windows only);2 6.6%</li> <li><span style="color: orange;">●</span> Glass windows with interior curtains.....;7 23.3 %</li> <li><span style="color: grey;">●</span> glass windows with an external packaging; 9 30%</li> <li><span style="color: yellow;">●</span> glass windows with an external packaging and internal curtains;12 40%</li> </ul> <p>Responses-Lighting -Q 30</p>
R1	<p>Result of Q1</p> <p>They use four kinds of windows, three of them are covered.</p>	<p>Almost their windows with internal curtains, so they don't prefer to use glass window without covering them (14%).</p>	<p>Most windows are also covered d with a degree of 70%.</p>



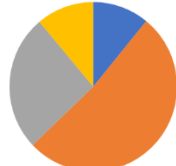

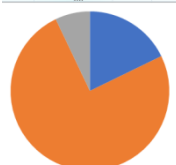
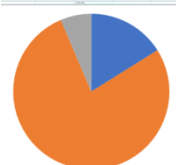
R2	Comparing the results	<p>This result shows us that; users don't prefer to use glasses windows without covered them by average of; 85% in AP and nearly 90% in DH, however, it used in TH by the average of 75%.</p> 		
Q.2	What is the size of the window openings (mostly) on the street	<ul style="list-style-type: none"> <li>● large windows ; 5 <u>20%</u></li> <li>● mid-size windows; 18 <u>72</u></li> <li>● Small windows ; 2 <u>8%</u></li> <li>No answer =1</li> </ul> <p>25 responses -Lighting-Q</p> 	<ul style="list-style-type: none"> <li>● large windows ;16(28.5%)</li> <li>● Mid-size windows; 39(69.6%)</li> <li>● Small windows; 1(1.7%)</li> </ul> <p>Six responses-Lighting-Q</p> 	<ul style="list-style-type: none"> <li>● large windows; 4 12.5 %</li> <li>● mid-size windows; 26 81.2 %</li> <li>● Small windows; 2 6.2 %</li> </ul> <p>32 responses-Lighting-Q</p> 
R2	Result Q2	72% of these windows are mid-size windows	Approximately 70% of these windows are medium-sized windows	Also, 80% of these windows are medium-sized windows
R2	Comparing the results	<p>all users using mid-size windows between 70% to 80%.</p> 		
Q.3	Do you use natural lighting during the day?	<ul style="list-style-type: none"> <li>● Yes , I use natural lighting.;16(62%)</li> <li>● No, , I use Artificial lighting ;14%</li> <li>● Both of them ;9(35%)</li> </ul> <p>26 responses- Lighting-Q</p> 	<ul style="list-style-type: none"> <li>● Yes, I use natural lighting.;38(69%)</li> <li>● No, I use Artificial lighting.;3(5.4%)</li> <li>● Both; 14(25.4%)</li> </ul> <p>55 responses-Lighting-Q</p> 	<ul style="list-style-type: none"> <li>● Yes, I use natural lighting.;21(65.6 %)</li> <li>● No, I use Artificial lighting. Both;11 34.3 %</li> </ul> <p>32 responses-Lighting-Q</p> 


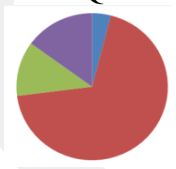
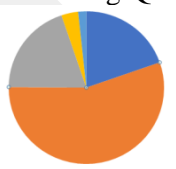
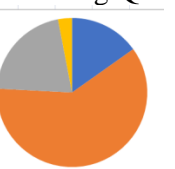
R3	<b>Result Q3</b>	The result shows us that, most of the people use natural lighting during the day light, so approximately 62 % of them use it.	Approximately 70 % of users using the natural lighting during the day lighting .	65% of users using the natural lighting . while 30% use both kind of lighting
R3	<b>Comparing the results</b>	<p>All examples of housing and apartment show us that, people using natural lighting during the day lighting with average of 60% to 70%</p> 		
Q4	<b>If the answer is yes, what is the way of lighting your indoor spaces</b>	<ul style="list-style-type: none"> <li><span style="color: blue;">●</span> I use window lighting ;9 38%</li> <li><span style="color: red;">●</span> I use the courtyard lighting;4 17%</li> <li><span style="color: green;">●</span> Both ;11 46%</li> <li>No answer =2</li> </ul>  <p>24 responses-Lighting-Q</p> 	<ul style="list-style-type: none"> <li><span style="color: blue;">●</span> I use window lighting;39(69.6 %)</li> <li><span style="color: grey;">●</span> I use the courtyard lighting;7 (12.5 %)</li> <li><span style="color: orange;">●</span> Both ;10 (17.8 %)</li> </ul>  <p>56 responses-Lighting-Q</p> 	<ul style="list-style-type: none"> <li><span style="color: blue;">●</span> I use window lighting;1753.1 %</li> <li><span style="color: orange;">●</span> I use the courtyard lighting;9 28.1 %</li> <li><span style="color: grey;">□</span> Both;6 18.7 %</li> </ul>  <p>32 responses-Lighting-Q</p> 
R4	<b>Result Q4</b>	Approximately 46% of users open windows on the courtyard and street	Most users' open windows on the street, which mean 70% of them using these windows.	Also, more than 50% users how to live in the modern housing using the windows that are open on the street more than window open in the courtyard.
R4	<b>Comparing the results</b>	<p>On two kinds of AP and MH users prefer to use windows that are open on the street.</p> 		




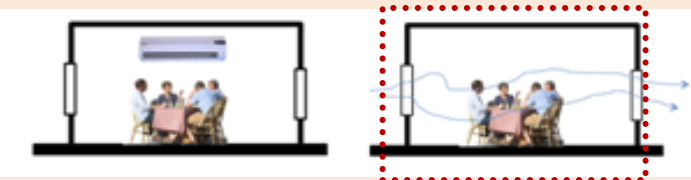

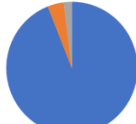

Q.5	<p>If you open the window, what kind of window do you open</p>	<ul style="list-style-type: none"> <li>● Glasses window f2 ;1150%</li> <li>● just out Screen window f1;523%</li> <li>● I open both of f1,f2,f3;627%</li> <li>No answer =3</li> </ul>  <p>22 responses-Lighting -Q</p> 	<ul style="list-style-type: none"> <li>● Glasses window f2;11(20.3)</li> <li>● just out Screen window f1;15(27.7)</li> <li>● I open both of f1, f2, f3;28 (51%)</li> </ul>  <p>54 responses-Lighting -Q</p> 	<ul style="list-style-type: none"> <li>● Glasses window f2;618.7%</li> <li>● just out Screen window f1;618.7%</li> <li>● I open both of f1, f2, f3;1959.3%</li> </ul>  <p>31 responses-Lighting-Q</p> 
R5	Result Q5	More than 50% open the glasses windows and closed the screen.	Approximately 50% of users open glasses window with the Screen and interior curtains.	60% of users open glasses window with the Screen and interior curtains.
R5	Comparing the results	<p>The results show that users open windows on the street without covering them.</p> <p>While the users in traditional housing open the glasses window only.</p> 		
Q.6	<p>If you do not open windows, so answer why don't open windows</p>	<ul style="list-style-type: none"> <li>● Losing the Privacy ;528%</li> <li>● Artificial lighting not expensive;844%</li> <li>● Because of dust and noise;528%</li> <li>No answer =8</li> </ul> <p>18 responses-Lighting-Q</p> 	<ul style="list-style-type: none"> <li>● Losing the Privacy;4 (28.5%)</li> <li>● Artificial lighting not expensive;1 (7.1%)</li> <li>● Because of dust and noise;9(64.2%)</li> </ul> <p>4 responses-Lighting-Q</p> 	<ul style="list-style-type: none"> <li>● Losing the Privacy;4 44.4%</li> <li>□ Artificial lighting not expensive;</li> <li>● Because of dust and noise;5 55.5%</li> </ul> <p>Nine responses-Lighting-Q</p> 

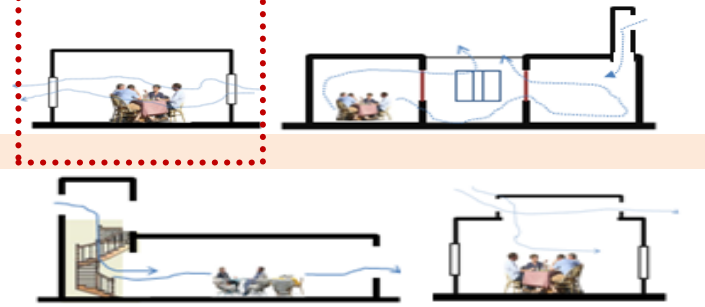


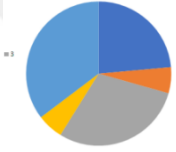
R6	<b>Result Q6</b>	44% users using Artificial lighting during the day lighting , because it not expensive.	64% of users prefer to closed windows due to dust and noise; while others closed it because they need the Privacy to their spaces	The userprefer to closed windows due to dust and noise as we see above, about 55% users.
R6	<b>Compa ring</b>	Users who close the windows in (AP& DH) answered that the reason is that of dust and pollution while th users in TH answered that the resin is becauseartificial lighting not expensive;		
Q.7	<b>Level of natural lighting</b>	<ul style="list-style-type: none"> <li><span style="color: blue;">●</span> V-Good ;<u>935%</u></li> <li><span style="color: purple;">●</span> Good;<u>1350%</u></li> <li><span style="color: red;">●</span> Acceptable ;<u>312%</u></li> <li><span style="color: green;">●</span> Bad :<u>14%</u></li> <li><span style="color: grey;">□</span> V-bad</li> </ul> <p>26 responses-Lighting-</p> 	<ul style="list-style-type: none"> <li><span style="color: blue;">●</span> V-Good ;31 (57.4%)</li> <li><span style="color: orange;">●</span> Good;22 (40.7%)</li> <li><span style="color: grey;">●</span> Acceptable ;1 (1.8%)</li> <li><span style="color: red;">□</span> Bad</li> <li><span style="color: green;">□</span> V-bad</li> </ul> <p>54 responses-Lighting-</p> 	<ul style="list-style-type: none"> <li><span style="color: blue;">●</span> V-Good ;23 71.8 %</li> <li><span style="color: orange;">●</span> Good;9 28 .1 %</li> <li><span style="color: grey;">□</span> Acceptable;</li> <li><span style="color: red;">□</span> Bad</li> <li><span style="color: green;">□</span> V-bad</li> </ul> <p>32 responses-ighting-</p> 
R7	<b>Result Q7</b>	50% of users ansewred that ; the naturallighting is good while 25% users sad it is very good.	The result presented that, most of thepeoplereplied that the level of lighting between very good and good	The results show that people are satisfied with natural lighting , so about 71% of them answered that they are very good.
	<b>Comparing the results</b>	The result show that natural lighting is <u>very good in their spaces</u> Kind of window;They use mid-size window and most of theusers open windows in daylighting and let the light enter in side thespaces.		
Q.8	<b>How do you cooling your spaces in the summer?</b>	<ul style="list-style-type: none"> <li><span style="color: blue;">●</span> Naturally ;4 15%</li> <li><span style="color: red;">●</span> Electrical fan 14%</li> <li><span style="color: green;">●</span> Air conditioning;2077%</li> <li><span style="color: purple;">●</span> Spaces do not need to be cooling because they are cooling : 14%</li> </ul> <p>26 responses- cooling-Q</p> 	<ul style="list-style-type: none"> <li><span style="color: blue;">●</span> Naturally;14 (25 %)</li> <li><span style="color: orange;">●</span> Electrical fan;1 (1.7 %)</li> <li><span style="color: grey;">●</span> Air conditioning; 36 (64.2 %)</li> <li><span style="color: yellow;">●</span> Spaces do not need to be cooling because they are cooling ;5 (8.9%)</li> </ul> <p>56 responses- cooling-Q</p> 	<ul style="list-style-type: none"> <li><span style="color: blue;">●</span> Naturally;4 12.5 %</li> <li><span style="color: orange;">●</span> Electrical fan;1 3.1 %</li> <li><span style="color: grey;">●</span> Air conditioning;26 81.2 %</li> <li><span style="color: yellow;">●</span> Spaces do not need to be cooling because they are cooling ;1 3.1 %</li> </ul> <p>32 responses- cooling-Q</p> 

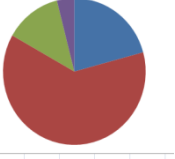





R8	<b>Result Q8</b>	77% of users used Air conditioning in TH.	Approximately 60% of users in AP using Air conditioning.	80% of users in MH also using Air conditioning.
R8	<b>Comparing the results</b>	<p>All users use Air condition instead of natural cooling</p>		
Q.9	<b>If the answer is Naturally, how?</b>	<ul style="list-style-type: none"> <li><span style="color: blue;">●</span> By windows ;964%</li> <li><span style="color: red;">●</span> By courtyard ;429%</li> <li><span style="color: green;">●</span> By Vacuum of the stairs 17%</li> <li>No answer =7</li> </ul> <p>14 responses -cooling-Q</p>	<ul style="list-style-type: none"> <li><span style="color: blue;">●</span> By windows; 34 (89.4 %)</li> <li><span style="color: orange;">●</span> By courtyard; 3 (7.8%)</li> <li><span style="color: grey;">●</span> By Vacuum of the stairs; 1 (2.6%)</li> </ul> <p>38 responses -cooling-Q</p>	<ul style="list-style-type: none"> <li><span style="color: blue;">●</span> By windows ;952.9 %</li> <li><span style="color: orange;">●</span> By courtyard ;4 23.5 %</li> <li><span style="color: grey;">●</span> By Vacuum of the stairs; 2 11.7 %</li> </ul> <p>responses -cooling-Q 17</p>
R9	<b>Result Q9</b>	64% of people in TH cooling their spaces by windows	90% of users prefer to open windows on street more than others ways	Also users in MH by average of 50% open windows on street
R9	<b>Comparing the results</b>	<p>All users cooling their spaces by opening window on street more than other ways</p>		

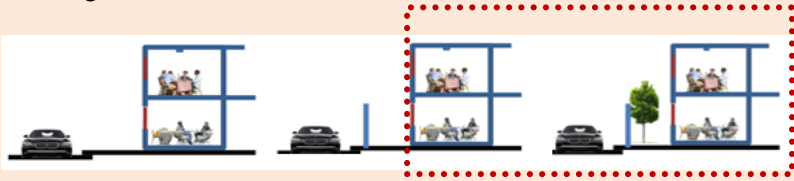
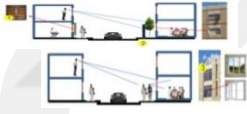



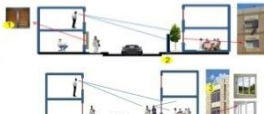

Q.10	Level of natural cooling	<ul style="list-style-type: none"> <li><span style="color: red;">●</span> V-Good ;314%</li> <li><span style="color: green;">●</span> Good; 1359%</li> <li><span style="color: purple;">●</span> Acceptable ;418%</li> <li><span style="color: grey;">●</span> Bad :29%</li> <li><span style="color: yellow;">□</span> V-bad</li> <li>No answer =1</li> </ul> <p>22 responses -cooling-Q</p> 	<ul style="list-style-type: none"> <li><span style="color: blue;">●</span> V-Good; 10 (18.8%)</li> <li><span style="color: orange;">●</span> Good; 26(49%)</li> <li><span style="color: grey;">●</span> Acceptable; 15 (28.3 %)</li> <li><span style="color: yellow;">●</span> Bad; 2 (3.7 %)</li> <li><span style="color: white;">□</span> V-bad</li> </ul> <p>53 responses -cooling-Q</p> 	<ul style="list-style-type: none"> <li><span style="color: blue;">●</span> V-Good;3 10.7 %</li> <li><span style="color: orange;">●</span> Good; 14 50 %</li> <li><span style="color: grey;">●</span> Acceptable ;7 25 %</li> <li><span style="color: yellow;">●</span> Bad ;3 10.7 %</li> <li><span style="color: white;">□</span> V-bad</li> </ul> <p>responses –cooling-Q</p> 
R10	Result Q10	Users responded that the level of cooling is good (59%)and acceptable (18%).	50% People are satisfied with the cooling level,and they say that it is good while 25% of users sad it is acceptable.	50% People are satisfied with the cooling level, and they say that it is good while 25% of users sad it is acceptable.
R10	Comparing the results	<p>All users are satisfied with the cooling level in their housing and apartment.</p> <p>Note1; However users of 77 % in TH and 60% in AP and 80% in DH, are using <u>Air condition</u> they said the level of cooling is between good and acceptable . in fact in this result, as we see it is paradoxical answer indicates that people do not know the true meaning of good cooling. ( the good cooling it is natural cooling, not artificial meaning )</p> <p>Note; users depending on electrical energy to cooling their spaces by average between 80% to 60%</p>		
Q.11	How do you heating your spaces in the winter?	<ul style="list-style-type: none"> <li><span style="color: blue;">●</span> Air conditioning; 3 12%</li> <li><span style="color: red;">●</span> Electrical boilers;21 81%</li> <li><span style="color: green;">●</span> Stove :14%</li> <li><span style="color: white;">□</span> The spaces are warm</li> <li><span style="color: purple;">●</span> Other way :14%</li> </ul> <p>26 responses- Heating-Q</p> 	<ul style="list-style-type: none"> <li><span style="color: blue;">●</span> Air condition;10 (17.8%)</li> <li><span style="color: orange;">●</span> Electrical boilers; 42 (75%)</li> <li><span style="color: white;">□</span> Stove; The spaces are warm; 4 (7.1%)</li> </ul> <p>56 responses- Heating-Q</p> 	<ul style="list-style-type: none"> <li><span style="color: blue;">●</span> Air condition; 5 16.1%</li> <li><span style="color: orange;">●</span> Electrical boilers; 24 77.4 %</li> <li><span style="color: white;">□</span> Stove;</li> <li><span style="color: grey;">●</span> The spaces are warm; 2 6.4%</li> </ul> <p>31 responses- Heating-Q</p> 

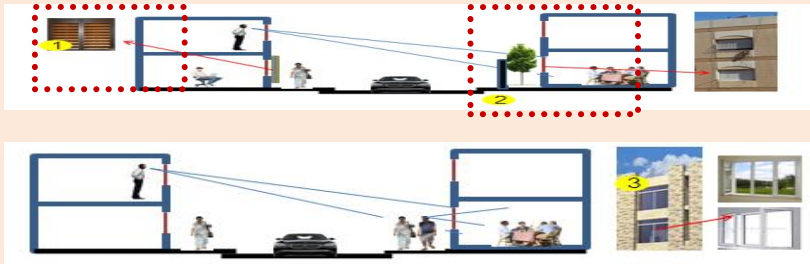


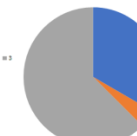
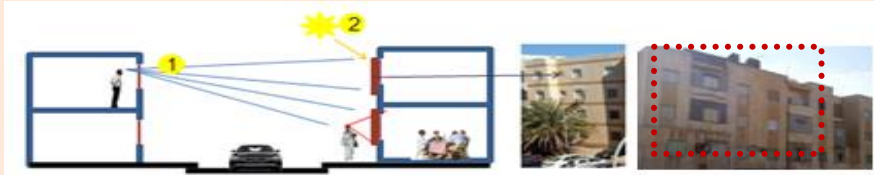
R11	Result Q11	12% of users using Air conditioning to heating their space . while <u>81%</u> use Electrical boilers.	<u>75%</u> of users using Electrical boilers to heating their spaces.	More than <u>75%</u> using Electrical boilers, while 25% using air condition
R11	Comparing the results	<p>All users how to live in two kinds of housing and apartment using electrical boilers in the same average of <u>75%</u>, while other using air condition with average between <u>12%</u> and 18%.  Note; users depending on electrical energy to heating their spaces by average of <u>100%</u></p> 		
Q.12	Level of heating	<ul style="list-style-type: none"> <li><span style="color: blue;">●</span> V-Good ;<u>14%</u></li> <li><span style="color: red;">●</span> Good;<u>18</u><u>69%</u></li> <li><span style="color: purple;">●</span> Acceptable ;<u>3</u><u>12%</u></li> <li><span style="color: green;">●</span> Bad ;<u>4</u><u>15%</u></li> <li><span style="color: grey;">□</span> V-bad</li> </ul> <p>26 responses Heating -Q</p> 	<ul style="list-style-type: none"> <li><span style="color: blue;">●</span> V-Good; 11 (19.6%)</li> <li><span style="color: orange;">●</span> Good;31 (55.3%)</li> <li><span style="color: grey;">●</span> Acceptable;11(19.6 %)</li> <li><span style="color: yellow;">●</span> Bad; 2 (3.5 %)</li> <li><span style="color: lightblue;">●</span> V-bad;1(1.7 %)</li> </ul> <p>56 responses Heating-Q</p> 	<ul style="list-style-type: none"> <li><span style="color: blue;">●</span> V-Good ;5 15.6%</li> <li><span style="color: orange;">●</span> Good;20 62.5 %</li> <li><span style="color: grey;">●</span> Acceptable;7 21.8 %</li> <li><span style="color: yellow;">●</span> Bad ;1 3.1 %</li> <li><span style="color: lightblue;">□</span> V-bad</li> </ul> <p>responses Heating-Q</p> 
R12	Result Q12	<u>69%</u> users said the level of heating is good while other said it is acceptable with an average of <u>12%</u> .	<u>55%</u> of users sad the level of heating is good	<u>60 %</u> of userssad the level of heating is good
R12	Comparing the results	<p>Between 69 % and 55% users sad heating level is good. While other users with an average of 15% answered, it is acceptable.  Nota; Although the ratio of the users how they use electricity is about 100%, they said that; the heating level is good and acceptable!!</p>		

Q.13	What kind of ventilation do you use in your spaces	<ul style="list-style-type: none"> <li><span style="color: blue;">●</span> Natural ventilation :25 100%</li> <li><span style="color: orange;">□</span> Artificial ventilation</li> <li>No answer =1</li> </ul> <p style="text-align: center;">25responses</p> 	<ul style="list-style-type: none"> <li><span style="color: blue;">●</span> Natural ventilation: 44(78.5 %)</li> <li><span style="color: orange;">●</span> Artificial ventilation; 12 (21.4%)</li> </ul> <p style="text-align: center;">56responses</p> 	<ul style="list-style-type: none"> <li><span style="color: blue;">●</span> Natural ventilation :31 96.8 %</li> <li><span style="color: orange;">●</span> Artificial ventilation ;1 3.1 %</li> </ul> <p style="text-align: center;">32responses</p> 
R13	Result Q13	<ul style="list-style-type: none"> <li><span style="color: orange;">□</span> 100% users use natural ventilation in their spaces.</li> </ul>	<ul style="list-style-type: none"> <li><span style="color: orange;">□</span> 80% % users use natural ventilation in their spaces. while 20% use Artificial ventilation.</li> </ul>	<ul style="list-style-type: none"> <li>95 % % users use natural ventilation in their spaces.</li> </ul>
R13	Comparing the results	<p style="text-align: center;">more than 80% users use natural ventilation in their housing.</p> 		
Q.14	How do your ventilation your spaces?	<ul style="list-style-type: none"> <li><span style="color: blue;">●</span> By windows ;2188%</li> <li><span style="color: red;">●</span> By courtyard ;14%</li> <li><span style="color: orange;">□</span> By Vacuum of the stairs</li> <li><span style="color: green;">●</span> By roof halls :28%</li> <li><span style="color: grey;">□</span> Others</li> <li>No answer =2</li> </ul> <p style="text-align: center;">24 responses - Ventilation-Q</p> 	<ul style="list-style-type: none"> <li><span style="color: blue;">●</span> By windows;46 (93.8)</li> <li><span style="color: orange;">●</span> By courtyard;2 (4%)</li> <li><span style="color: grey;">●</span> By Vacuum of the stairs;1 (2 %)</li> <li><span style="color: orange;">□</span> By roof halls</li> </ul> <p style="text-align: center;">49responses—</p> 	<ul style="list-style-type: none"> <li><span style="color: blue;">●</span> By windows;2787%</li> <li><span style="color: orange;">●</span> By courtyard;4 12.9 %</li> <li><span style="color: orange;">□</span> By Vacuum of the stairs</li> <li><span style="color: orange;">□</span> By roof halls</li> </ul> <p style="text-align: center;">31responses - Ventilation-Q</p> 
R14	Result Q14	88% of users using the windows to ventilation space	Also 90% of users in AP using the windows to ventilation space	Approximately 90% of people who live in this kind of housing use natural ventilation by windows.







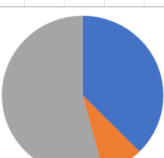
R14	Comparing the results	<p>Approximately 90% of users in a different kind of housing using the windows to ventilation their spaces.</p> 		
Q.15	Which floor has batterventilation	<ul style="list-style-type: none"> <li><span style="color: blue;">●</span> Ground floor;4 21 %</li> <li><span style="color: red;">●</span> First floor;3 16%</li> <li><span style="color: green;">●</span> Second floor;1 5%</li> <li><span style="color: purple;">●</span> Third floor 2 11%</li> <li><span style="color: lightblue;">●</span> More than 3 16%</li> <li><span style="color: orange;">●</span> No different ;6 32%</li> </ul> <p>19 responses-Ventilation-Q</p> 	<ul style="list-style-type: none"> <li><span style="color: blue;">●</span> Ground floor;2 (4.5 %)</li> <li><span style="color: orange;">●</span> First floor;5 (11.3%)</li> <li><span style="color: grey;">●</span> Second floor; 5 (11.3)</li> <li><span style="color: yellow;">●</span> Third floor; 8 (18.1%)</li> <li><span style="color: blue;">●</span> Fourth;8(18.1%)</li> <li><span style="color: green;">●</span> No different; 16(36.3 %)</li> </ul> <p>44 responses-Ventilation-Q</p> 	<ul style="list-style-type: none"> <li><span style="color: grey;">●</span> Ground floor;423.5 %</li> <li><span style="color: orange;">●</span> First floor;1 5.8 %</li> <li><span style="color: blue;">●</span> Second floor; 5 29.4</li> <li><span style="color: yellow;">●</span> Third floor ;1 5.8 %</li> <li><span style="color: lightblue;">●</span> No different ;6 35.2 %</li> </ul> <p>17 responses-Ventilation-Q</p> 
R15	Result Q15	<p>32% of users think there are no different between floors in theirventilation</p> <p>20% of users think the third and fourth floor have more ventilation than ground floor while 35% of users think there are no different between floors in theirventilation</p> <p>30% of users think the second floor has more ventilation than ground floor while 35% of users think it is no different between floors in theirventilation</p>		
R15	Comparin g the	<p>The result show us that,between 20 to 30 users think the higher floors have more ventilation than ground floor while 35% think it is no different between them</p>		



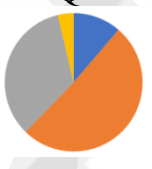
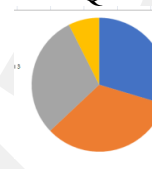
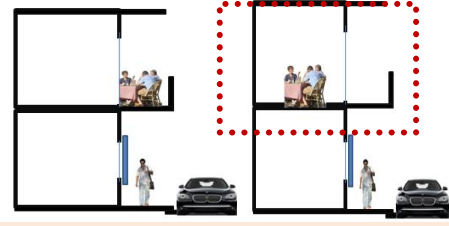
Q.16	Level of natural ventilation	<ul style="list-style-type: none"> <li><span style="color: blue;">●</span> V-Good ;5 21%</li> <li><span style="color: red;">●</span> Good; 15 63%</li> <li><span style="color: green;">●</span> Acceptable ;3 13%</li> <li><span style="color: purple;">●</span> Bad :1 4%</li> <li><span style="border: 1px solid black; display: inline-block; width: 10px; height: 10px;"></span> V-bad</li> </ul> <p>24responses-Ventilation-Q</p> 	<ul style="list-style-type: none"> <li><span style="color: blue;">●</span> V-Good; 23 (41.8 %)</li> <li><span style="color: orange;">●</span> Good; 24(43.6 %)</li> <li><span style="color: grey;">●</span> Acceptable; 7 (12.7 %)</li> <li><span style="color: yellow;">●</span> Bad; 1 (1.8 %)</li> <li><span style="border: 1px solid black; display: inline-block; width: 10px; height: 10px;"></span> V-bad</li> </ul> <p>55responses-Ventilation-Q</p> 	<ul style="list-style-type: none"> <li><span style="color: blue;">●</span> V-Good ;15 55.5%</li> <li><span style="color: orange;">●</span> Good; 12 44.4%</li> <li><span style="border: 1px solid black; display: inline-block; width: 10px; height: 10px;"></span> Acceptable;</li> <li><span style="border: 1px solid black; display: inline-block; width: 10px; height: 10px;"></span> Bad</li> <li><span style="border: 1px solid black; display: inline-block; width: 10px; height: 10px;"></span> V-bad</li> </ul> <p>27responses-ventilation-Q</p> 
R16	Result Q16	<p>63% People are satisfied with natural ventilation Level and they said that it is good while <u>21%</u> of users said it is very good and others said it is acceptable with an average of <u>13%</u>.</p> <p>40% of users answered that the level of natural ventilation is between very good and good</p> <p>Approximately <u>55%</u> of people think that the level of natural ventilation is very good while <u>45%</u> said it is good</p>		
R16	Comparing the	<p>All users satisfied with the level of natural ventilation with aratio of 89 %</p>		
Q.17	Which of these patterns do you have...?	<ul style="list-style-type: none"> <li><span style="color: blue;">●</span> Housing without fence;12 46%</li> <li><span style="color: red;">●</span> Housing with high fence;7 27%</li> <li><span style="color: green;">●</span> Housing with plants and a fence;7 27%</li> </ul> <p>26 responses- Privacy-Q</p> 	<ul style="list-style-type: none"> <li><span style="color: blue;">●</span> Housing without fence;19(41.3%)</li> <li><span style="color: orange;">●</span> Housing with high fence;14(30.4%)</li> <li><span style="color: grey;">●</span> Housingwith plants and a fence;13 (28.2 %)</li> </ul> <p>46responses- Privacy-Q</p> 	<ul style="list-style-type: none"> <li><span style="color: blue;">●</span> Housing without fence;4 13.3%</li> <li><span style="color: orange;">●</span> Housing withhigh fence;11 36.6%</li> <li><span style="color: grey;">●</span> Housing with plants and a fence;15 50%</li> </ul> <p>30 responses- Privacy-Q</p> 
R17	Result Q17	<p><u>27%</u> of users have a high fence, while <u>46%</u> live in housing with outfancy .</p> <p><u>70%</u> of apartments withfancy, while <u>30%</u> of them with outfancy .</p> <p><u>85%</u> modernhousing have fancy , while <u>15%</u> of housingwith outfancy .</p>		

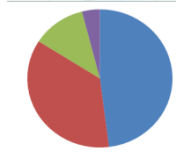

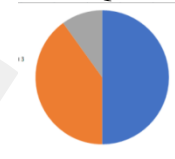
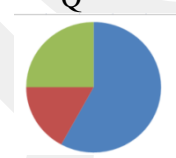
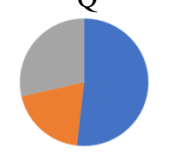
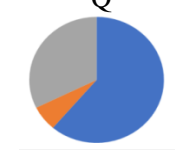
R17	Comparing the results	<p>Approximately 46% of users in TH live in housing with outfance , 41% of users in AP live in housing with outfance, and 86% of DH Housing with high fence.</p> 		
Q.18	Which of these designs exist in your home .....	<ul style="list-style-type: none"> <li><span style="color: blue;">●</span> Windows that obscure the vision (1);14 58%</li> <li><span style="color: red;">●</span> Wall that obscures the vision (2);1 4%</li> <li><span style="color: green;">●</span> Both....(1) ,(2);4 17%</li> <li><span style="color: purple;">●</span> Large windows and glass which not obscure vision....(3);2 8%</li> <li><span style="color: blue;">●</span> Glass windows (3) and fence which obscures the vision (2);3 13%</li> <li>No answer =2</li> </ul>  <p>24responses-Privacy</p> 	<ul style="list-style-type: none"> <li><span style="color: blue;">●</span> Windows that obscure the vision (1)18(36 .7%)</li> <li><span style="color: orange;">●</span> Wall that obscures the vision (2); 4 (8.1 %)</li> <li><span style="color: grey;">●</span> Both.... (1), (2);8 (16.3 %)</li> <li><span style="color: yellow;">●</span> Large windows and glass which not obscure vision.... (3)16 (32.6 %)</li> <li><span style="color: blue;">●</span> Glass windows (3) and fence which obscures the vision (2);3 (6.1 %)</li> </ul>  <p>49 responses-Privacy-</p> 	<ul style="list-style-type: none"> <li><span style="color: blue;">●</span> Windows that obscure the vision (1);5 16.6 %</li> <li><span style="color: orange;">●</span> Wall that obscures the vision (2);8 26.6 %</li> <li><span style="color: grey;">●</span> Both.... (1), (2);4 13.3 %</li> <li><span style="color: yellow;">●</span> Large windows and glass which not obscure vision.... (3);2 6.6 %</li> <li><span style="color: blue;">●</span> Glass windows (3) and fence which obscures the vision (2);11 36.6 %</li> </ul>  <p>30responses-Privacy</p> 
R18	Result Q18	58% of users have windows that obscure the vision	36% of apartments have windows that obscure the view,	16.6% of housing have windows that obscure the view, while they have Glass windows (3) and fence which obscures the vision (2);11 36.6



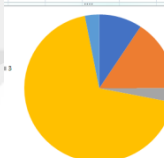
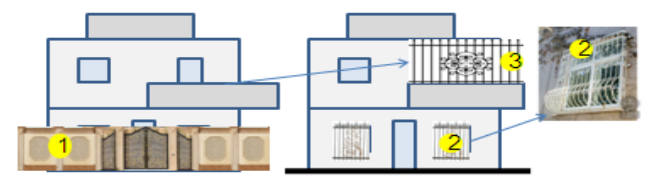
R18	Comparing the results	<p>58% of users in TH have windows that obscure the vision, while 35% users in AP have windows that obscure the vision. However 60% of DH have wall which obscures the vision,</p>  <p>Note: As result, users prefer to obscure indoor spaces from the vision out door spaces</p>		
Q.19	If you are closing the window during the day; What is the reason for closing the windows during the day	<ul style="list-style-type: none"> <li><span style="color: blue;">●</span> you don't like to be seen by neighbours (1);12 55%</li> <li><span style="color: brown;">●</span> you are not interest to the natural lighting 3 14%</li> <li><span style="color: green;">●</span> both; 3 14%</li> <li><span style="color: purple;">●</span> you prefer to closed windows without reason; 4 18%</li> <li>No answer =2</li> </ul> <p>22 responses-Privacy-Q</p> 	<ul style="list-style-type: none"> <li><span style="color: blue;">●</span> You don't like to be seen by neighbors (1);18(48.6 %)</li> <li><span style="color: orange;">●</span> You are not interested to the natural lighting (2);2 (5.4 %)</li> <li><span style="color: grey;">●</span> both;2 (5.4 %)</li> <li><span style="color: yellow;">●</span> You prefer to close windows without reason;15 (40.5 %)</li> </ul> <p>37 responses-Privacy-Q</p> 	<ul style="list-style-type: none"> <li><span style="color: blue;">●</span> you don't like to be seen by neighbors(1);833.3 %</li> <li><span style="color: orange;">●</span> you are not interested to the natural lighting (2);14.1 %</li> <li><span style="color: grey;">●</span> both;</li> <li><span style="color: grey;">●</span> you prefer to close windows without reason; 15 62.5 %</li> </ul> <p>24responses-Privacy-Q</p> 
R19	Result Q19	Approximately 55% of users don't like to be seen by neighbors	nearly 50% of users don't like to be seen by neighbors	30% of users don't like to be seen by neighbors while 60% of users prefer to close windows without reason
Comparing the results	<p>From 45% of users don't like to be seen by neighbors, while 40% of users prefer to close windows without reason.</p> 			

Q.20	What do you prefer about visitor's spaces...	<ul style="list-style-type: none"> <li>● Separation between women spaces and men spaces ;20 83%</li> <li>● No Separation;4 17%</li> <li>No answer =2</li> </ul> <p>24responses-Privacy-Q</p>	<ul style="list-style-type: none"> <li>● Separation between women spaces and men spaces; 52(94.5 %)</li> <li>□ No Separation;3 (5.4 %)</li> </ul> <p>55responses-Privacy-Q</p>	<ul style="list-style-type: none"> <li>● Separation between women spaces and men spaces ;29 93.5 %</li> <li>□ No Separation;2 6.4 %</li> </ul> <p>31responses-Privacy-Q</p>
R20	Result Q20	83% of users prefer to s separation between women spaces and men spaces	90% of users prefer to separation between women spaces and men spaces	Also, 90% users in DH users prefer to separation between women spaces and men spaces
R20	Comparin g the	From 83% to 90% of users separation between women spaces and men spaces		
Q.21	Do you combine the external balconies to the interior space.?	<ul style="list-style-type: none"> <li>● Yes;3 13%</li> <li>● No ;21 88%</li> <li>No answer =1</li> </ul> <p>24responses -Privacy-Q</p>	<ul style="list-style-type: none"> <li>● Yes; 14(25.4 %)</li> <li>● No;40 (72.7%)</li> </ul> <p>55responses -Privacy-Q</p>	<ul style="list-style-type: none"> <li>● Yes;414.2 %</li> <li>● No;24 85.7 %</li> </ul> <p>28 responses -Privacy-Q</p>
R21	Result Q21	88% of housing did not combine the external balconies to the interior space	70% of AP did not combine the external balconies to the interior space	Approximately 85% of housing did not combine the external balconies to the interior space
R21	Result Q21	From 70% to 85% case of housing and AP did not combine the external balconies to the interior space		

Q.22	If yes, why did you combine the external balconies to the interior	<ul style="list-style-type: none"> <li><span style="color: blue;">●</span> because the interior spaces are small;1 33%</li> <li><span style="color: orange;">●</span> Because of neighbors;2 67%</li> <li>No answer</li> </ul> 3 responses Privacy-Q 	<ul style="list-style-type: none"> <li><span style="color: blue;">●</span> Because the interior spaces are small;8 (44.4 %)</li> <li><span style="color: orange;">●</span> Because of neighbors ;10 (55.5 %)</li> </ul> 18 responses Privacy-Q 	<ul style="list-style-type: none"> <li><span style="color: blue;">●</span> because the interior spaces are small;4 66.6 %</li> <li><span style="color: orange;">●</span> Because of neighbors ;2 33.3 %</li> <li>No answer</li> </ul> 6 responses Privacy-Q 
R22	Result Q22	67% of users who they combine the external balconies to the interior space said that the reason because of the Privacy need.	55% of users said that the reason because of the Privacy need. while 45%users said that the reason because ofsmall spaces.	65%users said that the reason because of small spaces.
R22	Comparing the results	The results gave equal proportions for the reason of closing the balconies. 		
Q.23	If the answer is <u>no</u> , how t did you deal with the space of the balcony	<ul style="list-style-type: none"> <li><span style="color: blue;">●</span> left uncovered;5 36%</li> <li><span style="color: orange;">●</span> it is covered by with glass;5 36%</li> <li><span style="color: green;">●</span> it is covered with iron Protection;4 29%</li> <li><span style="color: grey;">□</span> Other answer (please specify).....</li> </ul> 14 responses -Privacy-Q 	<ul style="list-style-type: none"> <li><span style="color: grey;">●</span> left uncovered;16 (34.7 %)</li> <li><span style="color: orange;">●</span> It is covered by with glass;12(26 %)</li> <li><span style="color: blue;">●</span> it is covered with iron Protection;18 (39.1 %)</li> </ul> 46responses - Privacy-Q 	<ul style="list-style-type: none"> <li><span style="color: blue;">●</span> left uncovered;9 37.5</li> <li><span style="color: orange;">●</span> it is covered by with glass;2 8.33 %</li> <li><span style="color: grey;">●</span> it is covered with iron Protection;13 54.1 %</li> </ul> 24 responses -Privacy-Q 
R23	Result Q23	Nearly 36% of users covered the balcony by glass, while 36%of users covered the balcony by Iron Protection	39% of users covered the balcony by iron Protection. While26% of users covered the balcony by glass	More than 54 %of users covered the balcony by Iron Protection While28% of users covered the balcony by glass

R23	Comparing the results	<p>All results show us that;40 % of users in different kinds housing and apartments covered the balcony by the glass or iron Protection.</p> 		
Q.24	Do you sit with your family in the balcony?	<ul style="list-style-type: none"> <li>● Seldom;6 25%</li> <li>● No;14 58%</li> <li>● Sometimes;3 13%</li> <li>● Mostly;1 4%</li> <li>No answer =1</li> </ul> <p>24responses-Privacy-Q</p> 	<ul style="list-style-type: none"> <li>● Seldom;6 (11.3 %)</li> <li>● No;27 (50.9 %)</li> <li>● Sometimes;18 (33.9%)</li> <li>● Mostly;2 (3.7 %)</li> </ul> <p>53responses-Privacy-Q</p> 	<ul style="list-style-type: none"> <li>● Seldom;8 29.6 %</li> <li>● No;9 33.3 %</li> <li>● Sometimes;8 29.6 %</li> <li>● Mostly;2 7.4 %</li> </ul> <p>27responses-Privacy-Q</p> 
R24	Result Q24	58% of users do not prefer to sit on the balcony while 25% said that they seldom sit there	Also 50% of users do not prefer to sit on the balcony while 11% said that they seldom sit there	30% for each answer have same average, while 29% said that they seldom sit there
R24	Comparing the results	<p>Most of users do not prefer to sit on the balcony</p> 		

Q.25	Level of Privacy	<ul style="list-style-type: none"> <li><span style="color: blue;">●</span> V-Good ;12 48%</li> <li><span style="color: red;">●</span> Good;9 36%</li> <li><span style="color: green;">●</span> Acceptable ;</li> <li><span style="color: purple;">●</span> Bad ;3 12%</li> <li><span style="color: grey;">●</span> V-bad ;1 4%</li> <li>No answer =1</li> </ul> <p>25 responses Privacy-Q</p> 	<ul style="list-style-type: none"> <li><span style="color: blue;">●</span> V-Good;31(57.4 %)</li> <li><span style="color: orange;">●</span> Good;20(37%)</li> <li><span style="color: green;">●</span> Acceptable; 3 (5.5%)</li> <li><span style="color: red;">●</span> Bad</li> <li><span style="color: purple;">●</span> V-bad;</li> </ul> <p>54 responses Privacy-Q</p> 	<ul style="list-style-type: none"> <li><span style="color: blue;">●</span> V-Good ;15 50%</li> <li><span style="color: orange;">●</span> Good;12 40%</li> <li><span style="color: green;">●</span> Acceptable ;3 10%</li> <li><span style="color: red;">●</span> Bad</li> <li><span style="color: purple;">●</span> V-bad;</li> <li><span style="color: grey;">●</span></li> </ul> <p>30 responses Privacy-Q</p> 
R25	Result Q25	48% of users said the level of Privacy- is v- good	More than 55% of users said the level of Privacy- is v- good	50% of users said the level of Privacy- is v- good, while 40 % said it is good.
R25	Comparing the	50% of users said the level of Privacy- is very good. While 40 % of them said, it is good .		
Q.26	Would you prefer to live?	<ul style="list-style-type: none"> <li><span style="color: blue;">●</span> Live near relatives;14 58%</li> <li><span style="color: green;">●</span> No because the city is safe;4 17%</li> <li><span style="color: red;">●</span> No different ;6 25%</li> <li>No answer =1</li> </ul> <p>24 responses- Safety-Q</p> 	<ul style="list-style-type: none"> <li><span style="color: blue;">●</span> Live near relatives ;29 (51.7 %)</li> <li><span style="color: orange;">●</span> No because the city is safe;11 (19.6 %)</li> <li><span style="color: green;">●</span> No different;16(28.5 %)</li> </ul> <p>56 responses- Safety-Q</p> 	<ul style="list-style-type: none"> <li><span style="color: blue;">●</span> Live near relatives;19 61.2 %</li> <li><span style="color: orange;">●</span> No because the city is safe;2 6.45 %</li> <li><span style="color: green;">●</span> No different;10 32,2 %</li> </ul> <p>31 responses- Safety-Q</p> 
R26	Result	Nearly 58% of users prefer to Live near relatives.	Also, 50% of users prefer to Live near relatives	60% Live near relatives, while 30% of them said no different
R26	Comparing the	From 50 % to 60% of users prefer to Live near relatives.		







Q.27	How do you achieve safety goal at your house?	<ul style="list-style-type: none"> <li><span style="color: blue;">●</span> By High fence ; 1 4%</li> <li><span style="color: red;">●</span> By Closed windows ;13 50%</li> <li><span style="color: green;">□</span> By Closed balcony</li> <li><span style="color: green;">●</span> All above ;8 31%</li> <li><span style="color: purple;">●</span> Safety not important for me ;4 15%</li> </ul> <p>26responses- Safety-Q</p> 	<ul style="list-style-type: none"> <li><span style="color: blue;">●</span> By High fence;3 (5.3%)</li> <li><span style="color: orange;">●</span> By Closed windows;19 (33.9%)</li> <li><span style="color: grey;">●</span> By Closed balcony</li> <li><span style="color: grey;">●</span> balcony;4(7.1%)</li> <li><span style="color: yellow;">●</span> All above;20 (35.7%)</li> <li><span style="color: lightblue;">●</span> Safety not important for me;10 (17.8%)</li> </ul> <p>56 responses- Safety-Q</p> 	<ul style="list-style-type: none"> <li><span style="color: lightgrey;">□</span> By High fence ;3 9.3%</li> <li><span style="color: orange;">●</span> By Closed windows ;5 15.6%</li> <li><span style="color: lightblue;">●</span> By Closed balcony;1 3.1%</li> <li><span style="color: yellow;">●</span> All above ;22 68.75%</li> <li><span style="color: grey;">●</span> Safety not important for me ;1 3.1%</li> </ul> <p>32 responses- Safety-Q</p> 
R27	Result Q27	50% of users achieve the safety by the Closed windows, while 30%users said by all solutions that mentioned above.	33%of users achieve the safety by the Closed windows, while nearly 35%users said by all solutions that mentioned above.	68% of users in DH using all solutions that mentioned above.
R27	Comparing the results	<p>Between 33% to 68% using all solutions that achieve the safety goal in their housing or apartments.</p> 		










Q.28	Level of safety	<ul style="list-style-type: none"> <li><span style="color: red;">●</span> V-Good ;8 31%</li> <li><span style="color: blue;">●</span> Good;14 54%</li> <li><span style="color: green;">●</span> Acceptable ;3 12%</li> <li><span style="color: purple;">●</span> Bad ;</li> <li><span style="color: purple;">●</span> V-bad ;1 4%</li> </ul> <p>26 responses- Safety-Q</p>	<ul style="list-style-type: none"> <li><span style="color: blue;">●</span> V-Good;18 (33.3 %)</li> <li><span style="color: orange;">●</span> Good;32 (59.2 %)</li> <li><span style="color: grey;">●</span> Acceptable ;4 (7.4 %)</li> <li><span style="color: grey;">●</span> Bad</li> <li><span style="color: grey;">●</span> V-bad;</li> </ul> <p>54 responses- Safety-Q</p>	<ul style="list-style-type: none"> <li><span style="color: blue;">●</span> V-Good;18 56.2 %</li> <li><span style="color: grey;">●</span> Good;13 40.6 %</li> <li><span style="color: grey;">●</span> Acceptable ;1 3.1 %</li> <li><span style="color: grey;">●</span> Bad;</li> <li><span style="color: grey;">●</span> V-bad;</li> </ul> <p>32 responses- Safety-Q</p>
R28	Result	The result of safety level about 31% of users said it is very good while 54% Of father said it is good	60% of users said the level of safety- is good	Nearly 55% of users said the level of safety- is very good, while 40% said it is good.
R28	Comparing the	People are satisfied with the safety level with average of 60%		
Q.29	Do your housing faced characteristics.	<ul style="list-style-type: none"> <li><span style="color: blue;">●</span> Completed ;11 42%</li> <li><span style="color: red;">●</span> Incomplete;15 58%</li> </ul> <p>26 responses -Cost – Q</p>	<ul style="list-style-type: none"> <li><span style="color: blue;">●</span> Completed ;40(74 %)</li> <li><span style="color: orange;">●</span> Incomplete;14(25.9 %)</li> </ul> <p>54 responses -Cost – Q</p>	<ul style="list-style-type: none"> <li><span style="color: blue;">●</span> Completed ;24 75 %</li> <li><span style="color: orange;">●</span> Incomplete;8 25 %</li> </ul> <p>32 responses -Cost – Q</p>
R29	Result Q29	58% of users have not completed faced.	75% of users have completed faced .	75% of users have completed faced .
R29	Comparing the	75% of MH and AP have completed faced, while 58% of TH have not completed faced.		

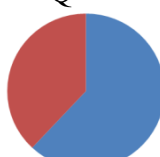
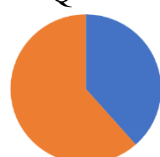
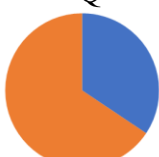
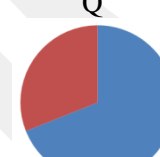


Q.30	What is the reason of incomplete housing	<ul style="list-style-type: none"> <li>The High cost of building facades ;9 64%</li> <li>Owner change the original plan which cost more</li> <li>add new floor ;5 36%</li> <li>No answer =9</li> </ul> <p>14 responses -Cost –</p> <p>Q</p>	<ul style="list-style-type: none"> <li>The High cost of building facades;12 70.5 %)</li> <li>Owner change the original plan which cost more;3 (17.6 %)</li> <li>add new floor;2(11.7 %)</li> </ul> <p>17 responses -Cost–</p> <p>Q</p>	<ul style="list-style-type: none"> <li>The High cost of building facades;7 87.5 %</li> <li>Owner change the original plan which cost more</li> <li>add new floor ;1 12.5 %</li> </ul> <p>8responses -Cost –</p> <p>Q</p>
R30	Result	64% of users said that the reason of incomplete housing due to the high cost	70% of users said that the reason of incomplete housing due to the high cost	Also, 85% of users said that the reason of incomplete housing due to the high cost
R30	Comparing the	The reasons for incomplete housing, due to the high cost.		
Q.31	after the construction, your housing or after moving to	<ul style="list-style-type: none"> <li>yes ;16 64%</li> <li>no ;9 36%</li> </ul> <p>25responses Cost –</p> <p>Q</p>	<ul style="list-style-type: none"> <li>yes;25 (46.2 %)</li> <li>no;29(53.7 %)</li> </ul> <p>54 responses Cost –</p> <p>Q</p>	<ul style="list-style-type: none"> <li>yes ;18 56.25 %</li> <li>no ;14 43.75 %</li> </ul> <p>32responses Cost–</p> <p>Q</p>
Q.32	how many times did you do modifications	<ul style="list-style-type: none"> <li>once;6 50%</li> <li>twice ;3 25%</li> <li>more than twice;3 25%</li> <li>No answer =2</li> </ul> <p>12 responses- Cost –</p>	<ul style="list-style-type: none"> <li>once24(77.4 %)</li> <li>twice;6 (19.3 %)</li> <li>more than twice;1(3.2 %)</li> </ul> <p>31 responses- Cost –</p>	<ul style="list-style-type: none"> <li>once;9 60 %</li> <li>twice;5 33.3 %</li> <li>more than twice;1 6.6 %</li> </ul> <p>15 responses- Cost –</p>
R31	Result Q31	50% of users did modifications just once.while 25 % did it more than twice.	More than 75% of users did modifications just once.	60%% of users did modifications just once, while 30% did it twice













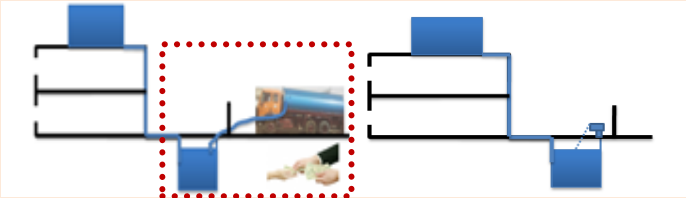
R31	Comparing the	Between 75% to 60% of users did modifications just once while 30% did it more than twice.		
Q.33	what kind of modification did you make	<ul style="list-style-type: none"> <li>● changing Room Size; 7 41%</li> <li>● Opening window on street; 1 6%</li> <li>● Cover the courtyard 1 6%</li> <li>● Build new floor ;5 29%</li> <li>● Using new materials to cover the facades ;3 18%</li> <li>□ Other type of modifications</li> </ul> <p>No answer =5</p> <p>17 responses Cost –</p> <p>Q</p>	<ul style="list-style-type: none"> <li>● changing Room Size 14(46.6 %)</li> <li>● Opening window on street;</li> <li>● Cover the courtyard;3 (10%)</li> <li>□ Build new floor ;3 (10%)</li> <li>● Using new materials to cover the facades; 10 (33.3 %)</li> </ul> <p>30 responses Cost –</p> <p>Q</p>	<ul style="list-style-type: none"> <li>● changing Room Size; 853.3 %</li> <li>□ Opening window on street;</li> <li>● Cover the courtyard;2 13.3 %</li> <li>● Build new floor ;5 33.3 %</li> <li>● Using new materials to cover the facades ;1 6.6%</li> </ul> <p>15 responses Cost –</p> <p>Q</p>
R33	Result Q33	41 % of users changed room Size, while 25% users Using new materials to cover the facades, and the same number for cover the facades.	45 % of users changed room Size, while 30% users Using new materials to cover the facades	50% of users changed room Size, while 30% of them Built new floor
R33	Comparing the	35% of users changed room Size, while between 25% to 30% of them Built new floor.		

Q.34	If the answer is yes, why you have made these modifications inside and outside the building	<ul style="list-style-type: none"> <li><span style="color: green;">●</span> the housing does not achieve the people's social needs;2 11%</li> <li><span style="color: red;">●</span> for more wide spaces;7 37%</li> <li><span style="color: blue;">●</span> Lack of privacy, safety ;2 11 %</li> <li><span style="color: purple;">●</span> People like to change without reason;8 42%</li> <li>No answer =4</li> </ul> <p style="text-align: center;">19 responses -Cost –</p> <p style="text-align: center;">Q</p>	<ul style="list-style-type: none"> <li><span style="color: blue;">●</span> the housing does not achieve the people's social needs;3 (17.6%)</li> <li><span style="color: orange;">●</span> for more wide spaces;14 (82.3 %)</li> <li><span style="color: grey;">●</span> Lack of privacy, safety;6 (35.2 %)</li> <li><span style="color: yellow;">●</span> People like to change without reason;8(47%)</li> </ul> <p style="text-align: center;">17 responses -Cost –</p> <p style="text-align: center;">Q</p>	<ul style="list-style-type: none"> <li><span style="color: blue;">●</span> the housing does not achieve the people's social needs; for more wide spaces;11 64.7 %</li> <li><span style="color: orange;">●</span> Lack of privacy, safety;</li> <li><span style="color: grey;">□</span> People like to change without reason;6 35.2 %</li> <li>Other reasons</li> </ul> <p style="text-align: center;">17 responses -Cost–</p> <p style="text-align: center;">Q</p>
R34	Result Q34	42% of users like to change without reason	80% chaining for more wide spaces	65% of users like to change without reason
R34	Comparin g the	42% to 65 % of users like to change without reason, while in AP users are changing for more wide spaces.		
Q.35	How much the cost of the electricity bill	<ul style="list-style-type: none"> <li><span style="color: blue;">●</span> I don't pay for it ;4 16%</li> <li><span style="color: red;">●</span> Inexpensive; 21 84%</li> <li><span style="color: green;">●</span> Expensive :1 4%</li> </ul> <p style="text-align: center;">25 responses-electricity</p> <p style="text-align: center;">-Q</p>	<ul style="list-style-type: none"> <li><span style="color: grey;">●</span> I don't pay for it ;12 (21.4 %)</li> <li><span style="color: orange;">●</span> Inexpensive; 39 (69.6 %)</li> <li><span style="color: blue;">●</span> Expensive; 5 (8.9 %)</li> </ul> <p style="text-align: center;">56 responses-electricity – Q</p>	<ul style="list-style-type: none"> <li><span style="color: blue;">●</span> I don't pay for it;23 85.1 %</li> <li><span style="color: orange;">●</span> Inexpensive; 4 14.8 %</li> <li><span style="color: grey;">□</span> Expensive</li> </ul> <p style="text-align: center;">27 responses-electricity–</p>
Result Q35	Result Q35	84% of users said that, cost of the electricity bill inexpensive	70% of users said that, the cost of the electricity bill in expensive.	85% of users said that they don't pay for electricity
Comparin g the	Comparin g the	The cost of electricity bill is not expensive		

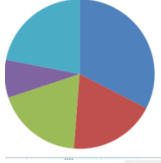
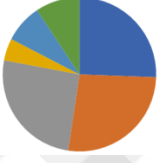
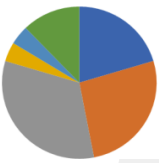
Q.36	was the electricity available before-2011	<ul style="list-style-type: none"> <li><span style="color: blue;">●</span> yes ;25 96%</li> <li><span style="color: red;">●</span> No ;1 4%</li> </ul> <p>26 responses-electricity- Q</p> 	<ul style="list-style-type: none"> <li><span style="color: blue;">●</span> yes;53(96.3 %)</li> <li><span style="color: orange;">●</span> no;2 (3.6 %)</li> </ul> <p>55esponses-electricity- Q</p> 	<ul style="list-style-type: none"> <li><span style="color: blue;">●</span> yes 9 93.5 %</li> <li><span style="color: orange;">●</span> no; 2 6.45 %</li> </ul> <p>31responses-electricity – Q</p> 
Result		100% of users said the electricity was available before-2011	95% 100% of users said the electricity was available before-2011	90% 100% of users said the electricity was available before-2011
Comparing the	Electricity was available before-2011			
Q.37	is the electricity available now?	<ul style="list-style-type: none"> <li><span style="color: blue;">●</span> yes ;4 15%</li> <li><span style="color: red;">●</span> no ;1 4%</li> <li><span style="color: purple;">●</span> mostly yes ;11 42%</li> <li><span style="color: green;">●</span> mostly no ;10 38%</li> </ul> <p>26 responses-electricity -Q</p> 	<ul style="list-style-type: none"> <li><span style="color: blue;">●</span> Yes;3 5.4 %</li> <li><span style="color: orange;">●</span> No;2 3.6 %</li> <li><span style="color: grey;">●</span> mostly yes ;27 49%</li> <li><span style="color: yellow;">●</span> mostly no ;23 41.8 %</li> </ul> <p>55responses-electricity- Q</p> 	<ul style="list-style-type: none"> <li><span style="color: blue;">●</span> yes ;4 12.5 %</li> <li><span style="color: red;">●</span> no; 1 3.1 %</li> <li><span style="color: orange;">●</span> mostly yes ;13 40.6 %</li> <li><span style="color: grey;">●</span> mostly no ;15 46.8 %</li> </ul> <p>32 responses-electricity-</p> 
R37	Result Q37	57% of users said the electricity is available now, while 42% of users said the electricity is not available now	55% of users said the electricity is available now, while 45% of users said the electricity is not available now	53 % of users said the electricity is available now,45% of users said the electricity is not available now
R37	Comparing the	55% said it is available.		

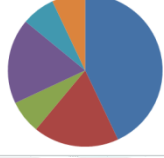

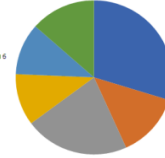



Q.38	<p>if the answer is no or sometimes, how do you do to lighting your house at night?</p>	<ul style="list-style-type: none"> <li><span style="color: blue;">●</span> Motor home electricity; 11 65%</li> <li><span style="color: red;">●</span> By traditional ways; 6 35%</li> <li><input type="checkbox"/> Bulbs charged with electricity</li> <li>No answer =4</li> </ul> <p>17 responses-electricity – Q</p> 	<ul style="list-style-type: none"> <li><span style="color: blue;">●</span> Motorhomeelectricity;46 (97.8%)</li> <li><span style="color: orange;">●</span> By traditional ways;1 (2.1 %)</li> <li><input type="checkbox"/> Bulbs charged with electricity</li> </ul> <p>47 responses-electricity– Q</p> 	<ul style="list-style-type: none"> <li><span style="color: blue;">●</span> Motorhomeelectricity;23 82.1 %</li> <li><span style="color: orange;">●</span> By traditional ways; 5 17.8 %</li> <li><input type="checkbox"/> Bulbs charged with electricity</li> </ul> <p>28 responses-electricity</p> 
R38	Result Q38	65% of users is lighting their housing by traditional ways, while 35% of users is lighting their housing by motor home electricity.	97% % of users lighting their housing by motor home electricity.	80% of users lighting their housing by motor home electricity. 20% of users lighting their housing by traditional ways,
R38	Comparing the results	<div style="display: flex; justify-content: space-around; align-items: center;"> <div style="text-align: center;">  <p>Generator</p> </div> <div style="text-align: center;">  <p>Traditional ways</p> </div> <div style="text-align: center;">  <p>Advanced ways</p> </div> </div> <p style="text-align: center;">Most users are lighting their housing by Generator</p>		
Q.39	What is your satisfaction with the level of electricity in your city	<ul style="list-style-type: none"> <li><span style="color: blue;">●</span> V-Good ;3 12%</li> <li><span style="color: red;">●</span> Good; 10 38%</li> <li><span style="color: green;">●</span> Acceptable ;3 12%</li> <li><span style="color: purple;">●</span> Bad ;8 31%</li> <li><span style="color: blue;">●</span> V-bad ;2 8%</li> </ul> <p>26 responses -electricity – Q</p> 	<ul style="list-style-type: none"> <li><span style="color: blue;">●</span> V-Good ;2 (3.5 %)</li> <li><span style="color: orange;">●</span> Good; 12(21.4 %)</li> <li><input type="checkbox"/> Good; 12(21.4 %)</li> <li><span style="color: grey;">●</span> Acceptable ;16 (28.5 %)</li> <li><span style="color: yellow;">●</span> Bad ;11 (19.6 %)</li> <li><span style="color: blue;">●</span> V-bad ;5 (8.9 %)</li> </ul> <p>56 responses - electricity – Q</p> 	<ul style="list-style-type: none"> <li><span style="color: blue;">●</span> V-Good ;1 3.1 %</li> <li><span style="color: orange;">●</span> Good; 4 12.5 %</li> <li><span style="color: grey;">●</span> Acceptable ;11 34.3 %</li> <li><span style="color: yellow;">●</span> Bad ;9 28.1 %</li> <li><span style="color: blue;">●</span> V-bad ;7 21.8 %</li> </ul> <p>32 responses - electricity –</p> 
R39	Result Q39	38% of users said the of Level of electricity is good, while 12 % said it is acceptable	30 % of users said the of Level of electricity is acceptable	More than 35% of users said the of Level of electricity is acceptable While 30% said, it is bad

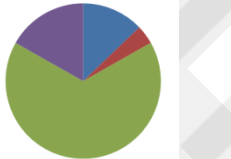
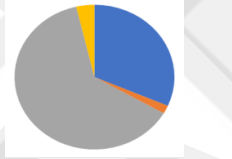
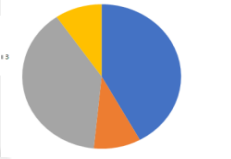
R39	Comparing	<ul style="list-style-type: none"> <li>- The highest percentage recorded in the traditional house is good level about 30%</li> <li>- The highest percentage recorded in apartments is the acceptable level about 30%</li> <li>- The highest percentage recorded in the modern house is the acceptable level about 12%</li> </ul>		
Q.40	Do you pay the bill to the government for water?	<ul style="list-style-type: none"> <li>Yes; 16 62%</li> <li>No; 10 38%</li> </ul> <p>12 responses Water-Q</p> 	<ul style="list-style-type: none"> <li>Yes; 15 (38.4%)</li> <li>No; 24(61.5 %)</li> </ul> <p>39 responses Water-Q</p> 	<ul style="list-style-type: none"> <li>Yes; 11 34.3 %</li> <li>No; 21 65.6 %</li> </ul> <p>32 responses Water-Q</p> 
R40	Result Q 40	62% of users pay the bill to the government for water, while, 38% don't pay for it.	Nearly 40 % of users pay the bill to the government for water, while, 60 % don't pay for it.	Nearly 35 % of users pay bill to the government for water, while, 65 % don't pay for it
R40	Comparing the	The result is close to each other, but mostly in AP and DH they don't by average of 60%		
Q.41	Does the water available before 2011	<ul style="list-style-type: none"> <li>Yes; 18 69%</li> <li>No; 8 31%</li> </ul> <p>11 responses-Water-Q</p> 	<ul style="list-style-type: none"> <li>Yes; 41 (73.2 %)</li> <li>No; 15 (26.7 %)</li> </ul> <p>56 responses-Water-Q</p> 	<ul style="list-style-type: none"> <li>Yes; 29 90.6 %</li> <li>No; 3 9.3 %</li> </ul> <p>32 responses-Water-Q</p> 
R41	Result Q 41	69% of users said it is available.	70% of users said it is available.	90% of users said it is available.
R41	Comparing the	The water is mostly available before 2011		







Q.42	Does the water available now?	<p>              Yes; 20 77%            No; 6 23%         </p> <p>26 responses-Water-Q</p> 	<p>              Yes; 32 (72.7%)            No; 12 (27.2 %)         </p> <p>44 responses-Water-Q</p> 	<p>              Yes; 24 75%            No; 8 25 %         </p> <p>32 responses-Water-Q</p> 
R42	Result Q 42	77% % of users said that the water is available.	70% of users said it is available.	75% of users said it is available.
R42	Comparing the	The water is mostly available now.		
Q.43	If the answer is no, how do you get the water	<p>              I Buy the water;11 85%            I have Well;2 15%            No answer =10         </p> <p>13 responses -Water-Q</p> 	<p>              I Buy the water;10 (37%)            I have Well; 17 (62.9 %)         </p> <p>27 responses -water-Q</p> 	<p>              I Buy the water;4 33.3 %            I have Well; 8 66.6 %         </p> <p>12 responses -Water-Q</p> 
R43	Result Q 43	85% of users buy the water, while 15% of users have Well	40% of users buy the water, while 60% of users have Well	30% of users buy the water, while nearly 70% % of users have Well
R43	Comparing the results	 <ul style="list-style-type: none"> <li>- 85% users of all users who live in TH said they buy the water</li> <li>- 30% ( 27 ) users of all users ( 44 )who live in AP said they have Well with average of 60% of them</li> <li>- 25% ( 12 ) users of all users (32) who live in DH said they have Well with average 70%</li> </ul>		

Q.44	What is your satisfaction for the water in your house	<ul style="list-style-type: none"> <li><span style="color: blue;">●</span> V-Good ;520%</li> <li><span style="color: red;">●</span> Good;11 44%</li> <li><span style="color: green;">●</span> Acceptable ;2 8%</li> <li><span style="color: purple;">●</span> Bad ;6 24%</li> <li><span style="color: lightblue;">●</span> V-bad ;1 4%</li> <li>No answer =1</li> </ul> <p>25 responses –Water-Q</p>	<ul style="list-style-type: none"> <li><span style="color: blue;">●</span> V-Good;23 48.9 .8 %)</li> <li><span style="color: orange;">●</span> Good;12 (25% %)</li> <li><span style="color: grey;">●</span> Acceptable ;7 (14.8 %)</li> <li><span style="color: yellow;">●</span> Bad ;4 (8.5 %)</li> <li><span style="color: cyan;">●</span> V-bad ;1 (2.1 %)</li> </ul> <p>47 responses -Water-Q</p>	<ul style="list-style-type: none"> <li><span style="color: blue;">●</span> V-Good;14 43.7 %</li> <li><span style="color: orange;">●</span> Good;13 40.6 %</li> <li><span style="color: grey;">●</span> Acceptable ;4 12.5 %</li> <li><span style="color: yellow;">●</span> Bad ;1 3.1 %</li> <li><span style="color: lightblue;">□</span> V-bad;</li> </ul> <p>32 responses -Water-Q</p>
R44	Result Q 44	24% of users said the level of water is bad, while 44% said good	50% of users said the level of water is very good, while 25% said well .	40 % of users said the level of water is very good, while 40% said well .
R44	Comparing the results	44% People who live in TH said it is good,85% of the bought water. 75% of people who live in AP said it is between very good and good, however, 30% of them have well. 80% of people who live in MH said it is between very good and good, however, 25% of them have well.		
Q.45	where do you prefer to live .....	<ul style="list-style-type: none"> <li><span style="color: blue;">●</span> Apartment ;1 4%</li> <li><span style="color: red;">●</span> Modern housing ;16 64%</li> <li><span style="color: green;">●</span> Traditional housing 31%</li> </ul> <p>25 responses-Future housing –Q</p>	<ul style="list-style-type: none"> <li><span style="color: orange;">●</span> Apartment; Modern housing;37(82.2 %)</li> <li><span style="color: blue;">●</span> Traditional housing ;17 (37.7 %)</li> </ul> <p>45responses-Future housing –Q</p>	<ul style="list-style-type: none"> <li><span style="color: blue;">●</span> Apartment; Modern housing;21 67.7 %</li> <li><span style="color: orange;">●</span> Traditional housing;10 32.2 %</li> </ul> <p>31 responses-Future housing -Q</p>
R45	Result Q 45	64% people prefer to live in modern housing. While 31% prefer to live-in traditional housing.	80% people prefer to live in modern housing, while 35% prefer to live-in traditional housing.	70% people prefer to live-in modern housing, while 30% prefer to living traditional housing.
R45	Comparing the	Most people in the different group prefer to live in modern housing. While 30% prefer to live in traditional housing		

Q,46	what is the most important element in the designing a house	<ul style="list-style-type: none"> <li><span style="color: blue;">●</span> Safety :12 40%</li> <li><span style="color: orange;">●</span> Privacy; 7 23%</li> <li><span style="color: grey;">●</span> Good ventilation and lighting system :7 23%</li> <li><span style="color: yellow;">●</span> Good Cooling and heating system :3 10%</li> <li><span style="color: lightblue;">□</span> Low cost</li> <li><span style="color: cyan;">●</span> Good functional design : 2 7%</li> </ul> <p>No answer =1</p> <p>30 responses</p> 	<ul style="list-style-type: none"> <li><span style="color: orange;">●</span> Safety;22 (25.5 %)</li> <li><span style="color: grey;">●</span> Privacy;23 (26.7)</li> <li><span style="color: blue;">●</span> Good ventilation and lighting system ;22(25.5 %)</li> <li><span style="color: yellow;">●</span> Good Cooling and heating system ;4(4.6%)</li> <li><span style="color: cyan;">●</span> Low cost;7 (8.1%)</li> <li><span style="color: green;">●</span> Good functional design8 (9.3 %)</li> </ul> <p>86 responses</p> 	<ul style="list-style-type: none"> <li><span style="color: blue;">●</span> Safety;1020 %</li> <li><span style="color: orange;">●</span> Privacy;13 26 %</li> <li><span style="color: grey;">●</span> Good ventilation and lighting system;16% 32</li> <li><span style="color: yellow;">●</span> Good Cooling and heating system;2 4%</li> <li><span style="color: lightblue;">□</span> Low cost;2 4%</li> <li><span style="color: green;">●</span> Good functional design; 6 12%</li> </ul> <p>50 responses</p> 
R46	Result Q 46	users in TH said the most important elements in the designing a house are safety (40% ) and good ventilation and lighting system (23%).	users in AP said the most important elements in the designing a house are safety and privacy (25% ) and good ventilation and lighting system (25%).	users in MH said the most important elements in the designing a house are safety and privacy (20 %-25% ) and good ventilation and lighting system (32%).
R46	Comparing the	The most important elements in designing a house as the result show us are;safety, privacy, ventilation, and lighting system		

Q.47	What the big problem for living in contrary housing / traditional housing for you ...	<ul style="list-style-type: none"> <li>● Function problems ;12 43%</li> <li>● Social problems;5 18%</li> <li>● Economic problems;2 7%</li> <li>● ventilation and lighting;5 18%</li> <li>● Cooling and heating;2 7%</li> <li>● water and electricityM 2 7%</li> </ul> <p style="text-align: center;">28 responses</p> 	<ul style="list-style-type: none"> <li>● Function problems ;23(29.8 %)</li> <li>● Social problems;21(27.2 %)</li> <li>● Economic problems;11 (14.2 %)</li> <li>● Ventilation and lighting;10(12.9 %)</li> <li>● Cooling and heating;5 (6.4 %)</li> <li>● Water and electricity;7(9%)</li> </ul> <p style="text-align: center;">77responses</p> 	<ul style="list-style-type: none"> <li>● Function problems ;11 29.7%</li> <li>● Social problems;5 13.5 %</li> <li>● Economic problems;8 21.6 %</li> <li>● ventilation and lighting;4 10.8 %</li> <li>● Cooling and heating;4 10.8 %</li> <li>● Water and electricity5 13.5 %</li> </ul> <p style="text-align: center;">37responses</p> 
R47	Result Q 47	43% of users said that; the big problem for living in TH is that; Function problems and ventilation and lighting	the big problem for living in AP is that; Function problems and social problems	the big problem for living in AP is that; function problems and economic problems
R47	Comparing the	We see here in MH, and AP people did not feel about environment problems ,while in TH 25% they feel about some environment problems.		
Q.48	Do you prefer to live in a house with.?	<ul style="list-style-type: none"> <li>● Artificial conditioning, lighting, ventilation; 11 46%</li> <li>● Natural conditioning ,lighting , ventilation ;13 54%</li> </ul> <p style="text-align: center;">24 responses-Future housing -Q</p> 	<ul style="list-style-type: none"> <li>● Artificial conditioning, lighting, ventilation; 17 (33.3 %)</li> <li>● Natural conditioning, lighting, ventilation; 34 (66.6 %)</li> </ul> <p style="text-align: center;">51responses-Future housing -Q</p> 	<ul style="list-style-type: none"> <li>● Artificial conditioning, lighting, ventilation; 13 43.3 %</li> <li>● Natural conditioning, lighting, ventilation;17 56.6%</li> </ul> <p style="text-align: center;">30 responses-Future housing-Q</p> 

R48	<b>Result Q 48</b>	54% of people prefer to live in a house with. natural conditioning, lighting, ventilation.	65% of people prefer to live in a house with. Natural conditioning, lighting, ventilation.	55% of people prefer to live in a house with. Natural conditioning, lighting, ventilation. While 45 % people prefer to live in a house with. Artificial conditioning
R48	<b>Comparing the</b>	People prefer to live in a house with. Natural conditioning, lighting, ventilation.		
Q.49	<b>Do you prefer a house with Courtyard?</b>	<ul style="list-style-type: none"> <li><span style="color: blue;">●</span> Yes :3 13%</li> <li><span style="color: red;">●</span> No;1 4%</li> <li><span style="color: green;">●</span> Garden with high wall:16 67%</li> <li><span style="color: purple;">●</span> Garden with low wall ;4 17%</li> <li><input type="checkbox"/> I do not no 24 responses-Future housing -Q</li> </ul> 	<ul style="list-style-type: none"> <li><span style="color: blue;">●</span> Yes ;17 (37.7 %)</li> <li><span style="color: orange;">●</span> No; 1(2.2%)</li> <li><span style="color: grey;">●</span> Garden with high wall: 34 (75.5 %)</li> <li><span style="color: yellow;">●</span> Garden with low wall; 2(4.4 %)</li> <li><input type="checkbox"/> I do not no 45 responses-Future housing -Q</li> </ul> 	<ul style="list-style-type: none"> <li><span style="color: blue;">●</span> Yes ;13 41.9 %</li> <li><span style="color: orange;">●</span> No; 3 9.6 %</li> <li><span style="color: grey;">●</span> Garden with high wall:12 38.7 %</li> <li><span style="color: yellow;">●</span> Garden with low wall ;3 9.6 %</li> <li><input type="checkbox"/> I do not no 31 responses-Future housing-Q</li> </ul> 
R49	<b>Result Q 49</b>	67% People in TH prefer a house with Garden with high wall	75% People in AP prefer a house with Garden with high wall	40% People in AP prefer a house with Garden with high wall, While 40% of them prefer a house with courtyard
R49	<b>Comparing the</b>	Most people prefer a house with Garden with a high wall, while 40% of people live in MH prefer a house with courtyard.		

Q.50	If the answer is yes, what is the benefit of courtyard ....	<ul style="list-style-type: none"> <li>● Has environmental benefit;2 14%</li> <li>● Has social benefit;7 50%</li> <li>● Has traditional value ;214%</li> <li>● All above :214%</li> <li>● I prefer without reason ;1 7%</li> </ul> <p>No answer =5</p> <p>14 responses-Future housing –Q</p> 	<ul style="list-style-type: none"> <li>● Has environmental benefit;4 (13.3 %)</li> <li>● Has social benefit;9 (30 %)</li> <li>● Has traditional value ;1(3.3%)</li> <li>● All above ;10 (33.3)</li> <li>● I prefer without reason;6(20%)</li> </ul> <p>30 responses-Future housing –Q</p> 	<ul style="list-style-type: none"> <li>● Has environmental benefit;4 21%</li> <li>● Has social benefit;3 15.7 %</li> <li>□ Has traditional value ;1 5.2 %</li> <li>● All above ;9 47.3 %</li> <li>● I prefer without reason ;2 10.5 %</li> </ul> <p>19 responses-Future housing–</p> 
R50	Result Q 50	The reason for choosing Courtyard housing is that it Has social benefit (50%)	The reason for choosing Courtyard housing is that it Has social benefit(30% )	The reason for choosing Courtyard housing is because the environmental, social benefit; and traditional value (50% )
Comparing the		People feel about the courtyard due to social benefit more than other benefits		
Q.51	if the answer is no, why do you not prefer to live in a house with Courtyard	<ul style="list-style-type: none"> <li>● Because of the vision of neighbor;2 14%</li> <li>● Due to exposure to rain and dust;7 50%</li> <li>● I do not feel the importance of it :2 14%</li> <li>● I don't prefer without reason ;3 21%</li> </ul> <p>No answer =5</p> <p>14 responses-Future housing –Q</p> 	<ul style="list-style-type: none"> <li>● Because of the vision of neighbor;7 (22.5 %)</li> <li>□ Due to exposure to rain and dust;10 (32.2 %)</li> <li>● I do not feel the importance of it;7(22.5%)</li> <li>□ I don't prefer without reason;7(22.7 %)</li> </ul> <p>31 responses-Future housing –Q</p> 	<ul style="list-style-type: none"> <li>● Because of the vision of neighbor;1 7.6 %</li> <li>□ Due to exposure to rain and dust;7 53.8 %</li> <li>● I do not feel the importance of it;3 23 %</li> <li>□ I don't prefer without reason;2 15.3 %</li> </ul> <p>13 responses-Future housing–Q</p> 

R51	Result Q51	50% of People in TH does not prefer to live in house with Courtyard due to exposure to rain and dust	30% of People in AP does not prefer to live in house with Courtyard due to exposure to rain and dust	50% of People in MH does not prefer to live in house with Courtyard due to exposure to rain and dust
R51	Comparing the results	Most answers were due to exposure to rain and dust.		

## APPENDIX (D)

### FINAL RESULT OF QUESTIONNAIRE

**Table 1; Final result of questionnaire**

Type	The Result of T.H	The Result of AP	The Result of DH
Privacy	<p>High fence ;</p> <ul style="list-style-type: none"> <li>• 54% of MH Housing with high fence</li> </ul> <p>Type of window ;</p> <ul style="list-style-type: none"> <li>• Windows that obscure the vision 58%</li> </ul> <p>83% of users prefer to separation between women spaces and men spaces</p>	<p>High fence ;</p> <ul style="list-style-type: none"> <li>• 58% of MH Housing with high fence</li> </ul> <p>Type of window ;</p> <ul style="list-style-type: none"> <li>• 36% of apartments have windows that obscure the view,</li> </ul> <p>90% of users prefer to separation between women spaces and men spaces</p>	<p>High fence ;</p> <ul style="list-style-type: none"> <li>• 86% of MH Housing with high fence</li> </ul> <p>Type of window ;</p> <ul style="list-style-type: none"> <li>• 16.6% of housing have windows that obscure the view</li> </ul> <p>Also, 90% users in DH users prefer to separation between women spaces and men spaces</p>
Result	<p>The reason for high fence and closing windows ;</p> <p>Approximately 55% of users don't like to be seen by neighbors</p>	<p>The reason for high fence and closing windows ;</p> <p>nearly 50% of users don't like to be seen by neighbors while 40 % of users prefer to close windows without reason</p>	<p>The reason for high fence and closing windows ;</p> <p>30% of users don't like to be seen by neighbors while 60% of users prefer to close windows without reason</p>
Result	From 83% to 90% of users separation between women spaces and men spaces		
What the problem?	<ul style="list-style-type: none"> <li>• Users in all kinds of housing prefer the privacy for all spaces .</li> <li>As result , privacy must take place inside and outside of Libyan housing .</li> <li>• The problem of privacy caused people created many solutions such as a high wall, covered windows, and balconies .</li> </ul>		

Safety	<p>50% of users achieve the safety by the Closed windows</p> <p>The result of safety level about 31% of users said it is very good while 54% Of father said it is good</p>	<p>33% of users achieve the safety by the Closed windows, while nearly 35% users said by all solutions of high fence , closed windows and balcony</p> <p>60% of users said the level of safety- is good</p>	<p>68% of users in DH using all solutions of high fence , closed windows and balcony</p> <p>Nearly 55% of users said the level of safety- is very good, while 40% said it is good.</p>
Result	<p>More protection used in the villa, by using all solutions of high fence , closed windows and balcony, while 50% of users achieve the safety by the Closed windows in TH</p>		
What the problem?	<ul style="list-style-type: none"> <li>• The problem of safety caused people created many solutions such as a high wall, covered windows, and balconies.</li> <li>• Protection is protected by windows and balconies with iron type in low floors , but high fence it used just for privacy</li> </ul>		
Ventilation and cooling	<p>Ventilation ;</p> <ul style="list-style-type: none"> <li>• 100% users use natural ventilation in their spaces</li> <li>• 84% of users answered that the level of natural ventilation is between very good and good</li> </ul> <p>Cooling ;</p> <ul style="list-style-type: none"> <li>• 77% of users used Air conditioning in TH.</li> <li>• most of them are ventilated their spaces by windows are located on the central and few of them on the outside (64%) while the rooms are ventilated them by the courtyard spaces ( 30%)</li> <li>• <u>73%</u> People are satisfied with the cooling level and they said that it is between very good and good</li> </ul>	<p>Ventilation ;</p> <ul style="list-style-type: none"> <li>• 80% % users use natural ventilation in their spaces</li> <li>• <u>85%</u> of users answered that the level of natural ventilation is between very good and good</li> </ul> <p>Cooling ;</p> <ul style="list-style-type: none"> <li>• Approximately 60%of users in AP using Air conditioning.</li> <li>• All users cooling their spaces by opening window on street(90 %)</li> <li>• 68% of People are satisfied with the cooling level</li> </ul>	<p>Ventilation ;</p> <ul style="list-style-type: none"> <li>• 95 %users use natural ventilation in their spaces.</li> <li>• <u>99%</u> of users answered that the level of natural ventilation is between very good and good</li> </ul> <p>Cooling ;</p> <ul style="list-style-type: none"> <li>• 80% of users in DH also using Air conditioning.</li> <li>• All users cooling their spaces by opening window on street(52%) and windows that located on service courtyard (24%)</li> <li>• <u>68%</u> People are satisfied with the cooling level</li> </ul>

Result	<p>Ventilation ;</p> <ul style="list-style-type: none"> <li>• More than 90 % users use natural ventilation in their housing. Also 90% of users in AP and V using the windows to ventilation space, while 88% in TH using the windows to ventilation space.</li> </ul> <p>cooling ;</p> <ul style="list-style-type: none"> <li>• All users use air condition , which means high temperature in the interior spaces.</li> <li>• It is strange that air conditioning is used in traditional homes</li> <li>• However users of 77 % in TH and 60% in AP and 80% in DH, are using <u>Air condition</u> they said the level of cooling is between good and very good . in fact in this</li> <li>• Note; users depending on electrical energy to cooling their spaces by average of 72%</li> </ul>		
What is the problem ?	<p>Solving the problem of depending on electricity in cooling the spaces</p> <ul style="list-style-type: none"> <li>• energy consumption</li> <li>• The house does not provide cool environment</li> <li>• As a result of lack of cooling and heating systems, people depend on electrical energy by an average of of 77 % in TH and 60% in AP and 80% in V, so the lack of electricity made users depended on small generators.</li> </ul>		
Heating	<ul style="list-style-type: none"> <li>• 81% of users use electrical boilers to heating their space .</li> </ul>	<ul style="list-style-type: none"> <li>• 75% of users using electrical boilers to heating their spaces.</li> </ul>	<ul style="list-style-type: none"> <li>• More than 75% using electrical boilers.</li> </ul>
Result	<p>All users how to live in three kinds of housing use electrical boilers ( 81 % in TH, 75% in AP and 75% in V )</p>		
What is the problem ?	<ul style="list-style-type: none"> <li>• Most housing are not warm in winter, therefore people are heating their spaces by electrical boilers with same average of ( 75% in AP, 81% TH and 75% in DH )</li> <li>• users depending on electrical energy to heating their spaces by average of 77%</li> <li>• high energy consumption in housing system</li> </ul>		
Natural lighting	<ul style="list-style-type: none"> <li>• People use natural lighting during the day (62 %)</li> <li>• Just in TH users They depend on the lighting coming from the inner courtyard (17%) or both windows that located on street (46%)</li> <li>• people are satisfied with natural lighting between good and very good by average of 85%</li> </ul>	<ul style="list-style-type: none"> <li>• Approximately 70 % of users using the natural lighting during the day</li> <li>• people are satisfied with natural lighting between good and very good by average of 98%</li> </ul>	<ul style="list-style-type: none"> <li>• 65% of users using the natural lighting .</li> <li>• people are satisfied with natural lighting between good and very good by average of 99%</li> </ul>

Result	<ul style="list-style-type: none"> <li>All People prefer to use nature lighting during the day time . (65% for all)</li> <li>In TH users take advantages of natural lighting that came from courtyards more than AP and DH because the use windows that are located on street ( 70% AP,50% V)</li> <li>All users are satisfied with the level of natural lighting, especially in AP and V more than TH.</li> </ul>		
What is the	<ul style="list-style-type: none"> <li>Find solutions that provide good natural lighting</li> </ul>		
Water provides	85% of users ( of 13 person )buy the water, while 15% of users have tank 24% of users said the level of water is bad, while 44% said good	40% of users (of 27 person ) buy the water, while 60% of users have tank 50% of users said the level of water is very good, while 25% said good	30% of users of (12 person ) buy the water, while nearly 70% % of users have tank 40 %of users said the level of water is very good, while 40% said good
Result	75% of users said the water is mostly available now, while 25% said it not .		
What is the	<ul style="list-style-type: none"> <li>water shortage by average of 25%</li> <li>The lack of water made people buy water .</li> </ul>		
Electricity provides	<ul style="list-style-type: none"> <li>84% of users said that, cost of the electricity bill inexpensive</li> <li>42% of users said the electricity is not available now</li> <li>65% of users is lighting their housing by traditional ways, while 35% of users is lighting their housing by motor home electricity.</li> </ul>	<ul style="list-style-type: none"> <li>70% of users said that, the cost of the electricity bill inexpensive.</li> <li>45% of users said the electricity is not available now</li> <li>97% % of users lighting their housing by motor home electricity.</li> </ul>	<ul style="list-style-type: none"> <li>85%of users said that they don't pay for electricity</li> <li>45% of users said the electricity is not available now</li> <li>80% of users lighting their housing by motor home electricity. 20% of users lighting their housing by traditional ways,</li> </ul>
Result	The cost of electricity bill is not expensive Most users are lighting their housing by motor home electricity. (80 %)		

What is the	45% of users in all kind of housing said the electricity is not available now, so there is problem of Supplying houses with electricity.
What Is A real Problem In These Houses :	<ul style="list-style-type: none"> <li>● Solve the problem of lack of privacy and safety .</li> <li>● Address the environment of problem of lighting, ventilation, cooling and heating</li> <li>● Resolving the issue of energy consumption of cooling and heating problem</li> <li>● Resolving the problem of lack of water and electricity.</li> </ul>



**Table 2; People's needs about future housing**

<i>Result in</i>	<i>Traditional Housing</i>	<i>Apartments</i>	<i>Detached Housing</i>
Where do you prefer to live .....	-64% people prefer to live in modern housing, while 31% prefer to live in traditional housing	80% of people prefer to live in modern housing, while 35% prefer to live in traditional housing.	-70% of people prefer to live in modern housing, while 30% prefer to live in traditional housing.
what is the most important element in the designing a house	-the most important element in the designing a house are safety (40% ) privacy and good ventilation and lighting system (23%).	-users in AP said the most important elements in the designing a house are safety and privacy (25% ) and good ventilation and lighting system (25%).	-users in DH said the most important elements in the designing a house are safety and privacy (25%) and good ventilation and lighting system(32%).
What the big problem for living in contrary housing / traditional housing for you ...	-Nearly 43% of users said that; the big problem for living in TH is that; Function problems and ventilation and lighting.	-the big problem for living in AP is that; Function problems and social problems	-the big problem for living in AP is that; function problems and economic problems.
Do you prefer to live in a house with.?	-More than 54% of people prefer to live in a house with. Artificial conditioning, lighting, ventilation.	-65% of people prefer to live in a house with. Natural conditioning, lighting, ventilation.	-55% of people prefer to live in a house with. Natural conditioning, lighting, ventilation. While 45 % people prefer to live in a house with. Artificial conditioning.
Do you prefer a house with Courtyard?	-67% People in TH prefer a house with Garden with high wall	75% People in AP prefer a house with Garden with high wall -The reason for choosing Courtyard housing is that it has social benefit (30% )	-40% People in AP prefer a house with Garden with high wall, While 40% of them prefer a house with Courtyard The reason for choosing Courtyard housing is because the environmental, social benefit; and traditional value (50% )
<u>If the answer is no</u> , why do you not prefer to live in house with Courtyard ( 21 of 24 person )	50% of People in TH does not prefer to live in house with Courtyard due to exposure to rain and dust	-30% of People in AP does not prefer to live in house with courtyard due to exposure to rain and dust	-50% of People in DH does not prefer to live in a house with Courtyard due to exposure to rain and dust.
People Needs;	<ul style="list-style-type: none"> <li>• First, people need privacy and safety solutions as the most important elements.</li> <li>• Second, they need solutions for lighting and ventilation system.</li> <li>• Third, they prefer housing with gardens more than courtyard.</li> <li>• Forth, they prefer high fences more than low fences.</li> </ul>		

**APPENDIX (E)**  
**TYPE OF QUESTIONS OF CASE STUDY HOUSING**  
**IN DERNA – CITY**

**A. Questions for the Traditional Home**

- 1. Building Year ...**
- 2. Year of demolition**
  - Did not demolish
  - Demolition in ...
- 3. Location of the building**

.....
- 4. The original floors of the building**
  - one floor
  - two floors
- 5. Number of floors that added later ;**
  - one floor
  - two floors
  - More than two
  - There is no new floors
- 6. Type of structure**
  - Loading walls
  - Concrete structure
- 7. What kind of windows do you have.....?**
  - Windows overlooking the street
  - Windows overlooking the inner courtyard
  - Both

**8. What is the size of the window openings (mostly) overlooking the street in your residence.....?**

- Large windows..... (large windows area of approximately 50% of the area of interfaces)
- Midsize windows..... (medium windows about 40-30% of the area of the facades)
- Small windows..... (small windows area of 30 - 10% of the area of interfaces)

**9. What is the size of the window openings (mostly) overlooking the inner courtyard in your residence.....?**

- Large windows..... (large windows area of approximately 50% of the area of interfaces)
- Medium sized windows..... (medium windows about 40-30% of the area of the facades)
- Small windows..... (small windows area of 30 - 10% of the area of interfaces)

**10. Do you use natural lighting during the day**

- Yes, use natural lighting
- No, use industrial lighting
- both

**10.1. If yes, or mostly natural lighting, how do you get natural light.....**

- Lighting through windows overlooking the street
- Lighting through the middle courtyard
- Both

**10.2. If you opened the windows on the street in the day, what kinds of windows do open...?**

- Glass only keeps the outer packing closed
- Outer packing (Persian) only keeps the glass closed
- Glass and (parsian) and curtains

**11. Do you have windows on the street**

- high (people in the street cannot see through the window because they are high)
- low (people in the street can see through the window because it is low)
- Medium height

**12. How the interior spaces are cooled in the summer ...**

- Use windows and other natural methods use electric fans

- Industrial air conditioning (air conditioner)
- Space does not need to cool, because it is cooled
- Another answer.....

**13. If you use natural cooling, this is more useful.**

- Cooling by windows that open on the street....
- Cooling by windows that open on the inner courtyard....
- Another answer..*Closing the windows because the rooms keep cool*.....

**14. How to warm the internal spaces in winter.....**

- By heater.
- By air conditioner
- By traditional ways
- Space does not need heating, because it is warm
- More ways.....

**15. What type of ventilation do you use in your home.....? (Before the power failure problem)**

- Natural ventilation
- Industrial ventilation

**16. If ventilation is normal, how is it.....?**

- Ventilation through windows overlooking the street
- Ventilation through the inner courtyard
- Ventilation by roof or picker
- Another answer.....

**17. If you live in more than a mandatory floor..... Which floors have the best ventilation**

- Ground floor
- First floor
- There is no first floor

**18. If you close the outside windows overlooking the street during the day, answer: Why shut the windows during the day.....**

- Do not prefer your interior spaces to be open to neighbors
- Do not prefer daylight
- due to dust and noise
- Both
- Other answers.....

**19. How to secure your home**

- Protect windows
- Do not use any protection
- Other methods.....

**20. After lodging, have you made adjustments in the interior spaces**

- Yes
- No

**21. How many times have you made adjustments?**

- times
- twice
- more than twice

**22. What kind of modifications**

- Change the size of internal spaces
- Close the inner courtyard
- Building a new floor
- Open windows on the street
- Encapsulation of external facades or only modification
- Another answer .....

**23. Why did you make these changes?**

- For expansion of some internal spaces
- Due to lack of privacy (close some open openings to see neighbors)
- Internal spaces and their partitions do not satisfy the inhabitants
- without reason just to change
- Another answer... ..

**24. . How to get water now**

- Buy water
- Own a well
- Water is readily available with some equipment

**25. Is the inner courtyard closed?**

- Yes
- No

**26. If yes, why was it closed?**

- due to dust and dust
- Due to intense lighting
- Because of rain
- All the above
- There is no reason for this

- because of seeing neighbors
- Another answer. All above

## **B. Contemporary House**

### **1. What kind of windows do you have.....?**

- Glass windows only
- Glass windows with internal curtains blocking the vision
- Glass windows with external packaging
- Glass windows with external packaging and internal curtains

### **2. What is the size of the window openings (mostly) overlooking the street in your residence.....?**

- Large windows..... (large windows area of approximately 50% of the area of interfaces)
- Midsize windows..... (medium windows about 40-30% of the area of the facades)
- Small windows..... (small windows area of 30 - 10% of the area of interfaces)

### **3. Do you use natural lighting during the day ... (before 2011)**

- Yes, use natural lighting
- No, use industrial lighting instead of it
- Both

#### **3.1. If yes, or mostly using natural lighting, how do you get natural lighting.....**

- Lighting through windows that have overlooking on the street
- Lighting through the middle courtyard
- lighting through the windows that have overlooking on the street and the courtyard service .

#### **3.2. If you open the windows on the street in the daytime, any kind of windows will open.**

- Glass only keeps the outer packing closed
- Outer packing (Persian) only keeps glass closed
- Glass and (Persian) and curtains

#### **3.3. If no answer, why not use natural daylight lighting.....**

- lose privacy (be seen by passersby and neighbors)
- I do not need natural lighting because industrial lighting does not cost physically
- Do not open external windows to prevent dust and noise during the day

**4. How the interior spaces are cooled in the summer**

- Use windows and other natural methods
- Use electric fans
- Industrial air conditioning (air conditioner)
- Space does not need to cool, because it is relatively refrigerated
- Other answer

**5. If you use natural cooling, this is more useful.**

- Cooling windows open....
- Cooling in the inner courtyard.
- Ventilation cooling by vacuum stairs ...
- Another answer.....

**6. How to warm the internal spaces in winter.....**

- By heater
- By air conditioner
- By igniting coal or fire
- Space does not require heating, it is relatively warm
- More ways.....

**7. What type of ventilation do you use in your home or apartment.....**

- Natural ventilation
- Industrial ventilation

**8. if ventilation is normal, how is it .....**

- Ventilation through windows
- Ventilation through the inner courtyard
- Ventilation through the roof
- Ventilation through vacuum stairs
- Ventilation by windows and vacuum ladder

**9. If you live in more than a mandatory floor..... Which floors have the best ventilation.....?**

- Ground floor
- First floor
- Second floor
- Floor.....
- There is no difference between them

**10. Any of these patterns you have.....**

- Flat without wall
- dwelling with high wall

- dwelling with walls and plants obscures vision
- There is no wall because the building is directly on the street

**11. Which of these methods are present in your dwelling.....?**

- Windows obscures visibility
- Surges the visibility
- Both
- Wide, glass windows do not obscure vision
- Glass windows and fence blocking vision
- Another answer.....

**12. If you close the outside windows during the day, you must answer: What is the reason for closing the windows during the day?**

- Do not prefer your interior spaces to be open to neighbors
- Do not prefer daylight
- Both
- Other answers.....

**13. What do you prefer about guest space....?**

- Separate space between men and women
- No importance for separation

**14. Have you joined the outer balconies of the interior space or not?**

- Yes
- No

**14.1. If the answer is yes, why was the balcony enclosed to the interior space?**

- Because the inner spaces are narrow
- so as not to be exposed to see people

**14.2. If not, how did you deal with the balcony space**

- Leave it open
- Packed with glass
- Packed with iron protection

**15. How to secure your home or apartment**

- Surround the building with a high wall
- Protect windows
- Protection of balconies
- All that is said
- Do not use any protection
- Other methods.....

**16. After lodging, have you made adjustments in the interior spaces**

- Yes
- No

**17. How many times have you made adjustments?**

- times
- twice
- more than twice
- There is no

**18. What kind of modifications**

- Change the size of internal spaces
- Close the inner courtyard
- Building a new floor
- Open windows on the road
- Encapsulation of external facades or only modification
- More answer.....
- There is no

**19. Why did you make these changes?**

- For expansion of some internal spaces
- Due to lack of privacy (close some open openings to see neighbors)
- Internal spaces and their partitions do not satisfy the inhabitants
- without reason just to change
- More answer.....
- I did not make any changes.....

## APPENDIX (F)

### Comparing between traditional and contemporary housing

Comparison type	Traditional House	Detached House
1. Which is more comfortable in terms of cooling and ventilation?	<i>The traditional house is better than the modern house</i>	
2. What is the level of natural cooling and ventilation?	<input type="checkbox"/> Excellent <input type="checkbox"/> Good <input type="checkbox"/> Acceptable <input type="checkbox"/> Bad <input type="checkbox"/> Very bad	<input type="checkbox"/> Excellent <input type="checkbox"/> Good <input type="checkbox"/> Acceptable <input type="checkbox"/> Bad <input type="checkbox"/> Very bad
3. In your opinion what reason for this cooling?	<i>Openness to internal construction</i>	
4. 4. Which is better in terms of lighting?	<i>The traditional house is better than the modern house</i>	
5. What is the level of natural lighting?	<input type="checkbox"/> Excellent <input type="checkbox"/> Good <input type="checkbox"/> Acceptable <input type="checkbox"/> Bad <input type="checkbox"/> Very bad	
6. In your opinion the reason for this lighting?	The courtyard	
7. Which is better in terms of heating system?	<i>The traditional house is better than the modern house</i>	
8. What is the level of heating in winter	<input type="checkbox"/> Excellent <input type="checkbox"/> Good <input type="checkbox"/> Acceptable <input type="checkbox"/> Bad <input type="checkbox"/> Very bad	Excellent <input type="checkbox"/> Good <input type="checkbox"/> Acceptable <input type="checkbox"/> Bad <input type="checkbox"/> Very bad
9. In your opinion what reason for this heating?	<i>Good insulation of the Materials</i>	
10. Which is more private?		<i>The traditional house is better than the modern house</i>
11. In your opinion why this privacy		<i>Split partitions</i>

12. What is your estimate of the level of privacy in your home?	<input type="checkbox"/> Excellent <input type="checkbox"/> Good <input type="checkbox"/> Acceptable <input type="checkbox"/> Bad <input type="checkbox"/> Very bad	<input type="checkbox"/> Excellent <input type="checkbox"/> Good <input type="checkbox"/> Acceptable <input type="checkbox"/> Bad <input type="checkbox"/> Very bad
13. Which is better in safety system	<i>The traditional house is better than the modern house</i>	
14. Level of safety	<input type="checkbox"/> Excellent <input type="checkbox"/> Good <input type="checkbox"/> Acceptable <input type="checkbox"/> Bad <input type="checkbox"/> Very bad	<input type="checkbox"/> Excellent <input type="checkbox"/> Good <input type="checkbox"/> Acceptable <input type="checkbox"/> Bad <input type="checkbox"/> Very bad
15. What are the advantages of the house?	<input type="checkbox"/> <i>more cool in summer</i> <input type="checkbox"/> <i>Warmer winter</i> <input type="checkbox"/> <i>Good daylight lighting</i> <input type="checkbox"/> <i>has wonderful architectural features (more beautiful)</i> <input type="checkbox"/> <i>Lowest maintenance cost</i> <input type="checkbox"/> <i>More privacy</i> <input type="checkbox"/> <i>Other features</i>	<input type="checkbox"/> <i>more cool in summer</i> <input type="checkbox"/> <i>Warmer winter</i> <input type="checkbox"/> <i>Both</i> <input type="checkbox"/> <i>Good ventilation</i> <input type="checkbox"/> <i>Good daylight lighting</i> <input type="checkbox"/> <i>has a magnificent architectural characteristics (more beautiful)</i> <input type="checkbox"/> <i>Lowest maintenance cost</i> <input type="checkbox"/> <i>More privacy</i> <input type="checkbox"/> <i>Another answer</i>
16. What are the disadvantages of the house.....?	<input type="checkbox"/> <i>The presence of the inner courtyard because it is exposed to air and dust</i> <input type="checkbox"/> <i>There are no windows on the street</i> <input type="checkbox"/> <i>Due to the inability of the walls to adjust</i> <input type="checkbox"/> <i>The model is old and not beautiful</i> <input type="checkbox"/> <i>Maintenance costs higher than the modern house</i> <input type="checkbox"/> <i>Another reason</i>	<input type="checkbox"/> <i>Less ventilation and cooling in summer</i> <input type="checkbox"/> <i>Winter is less warm</i> <input type="checkbox"/> <i>Construction cost is high</i> <input type="checkbox"/> <i>Less private than traditional home</i> <input type="checkbox"/> <i>Other disadvantages.....</i>
17. Which housing is better for you?		<i>Detached housing is better than traditional housing</i> <i>As users said</i>

## CURRICULUM VITAE

### PERSONAL INFORMATION

Surname, Name: Sasi , Eman  
Nationality: Libya  
Date and Place of Birth: 27 march 1974 , Derna  
Marital Status: Married  
Phone: 05312037342  
email: ema.sasi@yahoo.com

### EDUCATION

Degree	Institution	Year of Graduation
MS	Istanbul Cultural University	2007
BS	University of Omar Mukhtar	1997
High School	School of AL Seada Khadija	1992

### WORK EXPERIENCE

Year	Place	Enrollment
2007- 20013	University of Omar Mukhtar/ Derna	I was a teacher in the Department of Urban and Architectural Design
2003-2007	Istanbul Cultural University	Master student
2002-2003	University of Omar Mukhtar/ Derna	Research Assistant
1997-2002	Khawla Institute/ Derna	Teacher in high school

### FOREIGN LANGUAGES

Advanced English

### PUBLICATIONS

Sasi E.(2013). "The stages of the development of the city of Drna" Bengazi , Libya  
( Master Theses )

Sasi E.(2013). "Landscape Arcitecture" Bengazi , Libya

Sasi E & Agfer .N .(2013). "What is urban design" Bengazi , Libya

### HOBBIES

Drawing and reading books