

USE OF LEDS AS FUTURE LIGHT SOURCES

A THESIS SUBMITTED TO  
THE GRADUATE SCHOOL OF NATURAL AND APPLIED SCIENCES  
OF  
ÇANKAYA UNIVERSITY

BY  
K.VOLKAN DEMİREL

IN PARTIAL FULFILLMENT OF THE REQUIREMENTS  
FOR  
THE DEGREE OF MASTER OF SCIENCE  
IN  
ELECTRONIC AND COMMUNICATION ENGINEERING

JUNE 2009

Title of the Thesis: **Use of LEDs as Future Light Sources**

Submitted by **K.Volkan Demirel**

Approval of the Graduate School of Natural and Applied Sciences, Çankaya  
University



Prof.Dr.Yahya Kemal BAYKAL

Acting Director

I certify that this thesis satisfies all the requirements as a thesis for the degree of  
Master of Science.



Prof.Dr.Yahya Kemal BAYKAL

Head of Department

This is to certify that we have read this thesis and that in our opinion it is fully  
adequate, in scope and quality, as a thesis for the degree of Master of Science.



Assoc.Prof.Dr.Halil Tanyer EYYUBOĞLU

Supervisor

**Examination Date** : 17.06.2009

**Examining Committee Members :**

Assistant.Prof. Dr. Şevki DEMİRBAŞ (Gazi Univ)

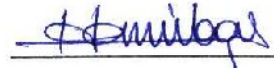

Assoc. Prof. Dr. Halil T. EYYUBOĞLU (Çankaya Univ.)



Assistant.Prof. Dr. Serap A. ARPALI (Çankaya Univ.)



## STATEMENT OF NON-PLAGIARISM PAGE

I hereby declare that all information in this document has been obtained and presented in accordance with academic rules and ethical conduct. I also declare that, as required by these rules and conduct, I have fully cited and referenced all material and results that are not original to this work.

Name, Last Name : K.Volkan DEMİREL  
Signature :   
Date : 17.06.2009

## **ABSTRACT**

### **USE OF LEDS AS FUTURE LIGHT SOURCES**

Demirel, Volkan

M.S.C., Department of Electronics and Communication Engineering

Supervisor : Assoc.Prof.Dr.Halil Tanyer EYYUBOĞLU

JUNE 2009, 60 pages

LEDS are conventionally used as indicators in control panels, and also for light sources in low power optic communication applications. Recently, high power and more efficient LEDs have appeared on the market. This study will investigate the use of LEDs for illumination purposes taking into account historical developments and future trends.

Keywords: Leds, Power Leds, Lighting

## ÖZ

### GELECEKTEKİ IŞIK KAYNAKLARINDA LED KULLANIMI

Demirel, Volkan

Yükseklisans, Elektronik ve Haberleşme Mühendisliği Anabilim Dalı

Tez Yöneticisi : Doç.Dr.Halil Tanyer EYYUBOĞLU

Haziran 2009, 60 sayfa

LEDler günümüze kadar genellikle elektronik panellerde gösterge olarak, ya da düşük güç gerektiren optik haberleşme sistemlerinin bir kısmında ışık kaynağı olarak kullanıldı. Günümüzde piyasada kendine yer bulan *PowerLed* ve benzer güçlü teknolojiler LEDlerin pazardaki uygulama alanlarını değiştirdi. Bu çalışmada LEDlerin aydınlatmadaki tarihçesi ele alınıp, gelecekteki teknoloji eğilimi nasıl olacağı sorusu yanıtlanmaya çalışılmıştır.

Anahtar Kelimeler: Ledler, Güç Ledleri, Aydınlatma

## ACKNOWLEDGEMENTS

I would like to express my sincere appreciation and gratitude to my supervisor Assoc. Prof. Dr. Halil Tanyer EYYUBOĞLU for his guidance, advice, critics, encouragement and insight throughout the research.

I would like to thank my father Ruşen DEMİREL, my mother Belgin DEMİREL and friends for their patent.

GCRI

## TABLE OF CONTENTS

STATEMENT OF NON-PLAGIARISM .....	iii
ABSTRACT .....	iv
ÖZ .....	v
ACKNOWLEDGEMENTS .....	vi
TABLE OF CONTENTS .....	vii
LIST OF TABLES .....	ix
LIST OF FIGURES .....	x
CHAPTERS:	
1. INTRODUCTION .....	1
1.1 History .....	1
2. LED TECHNOLOGY .....	4
2.1 How LED Work .....	4
2.2 Wavelength of LED .....	6
2.3 LED Types.....	8
2.3.1 Low Power LEDs.....	8
2.3.2 High Power LEDs .....	9
3. LED APPLICATIONS .....	10
3.1 Renewable Energy Sources .....	10
3.1.1 Wind Turbines.....	10
3.1.2 Solar Panels.....	12
3.2 Traffic Signs .....	16
3.3 Wall Washers.....	17
3.4 Choosing The LED in Different Applications.....	18
4. HPLED OUTDOOR ILLUMINATION EXPERIMENT.....	21
4.1 Experiment Introduction.....	21
4.2 Experiment Overview.....	21

4.3 Measurement .....	22
4.4 Mathematical Approximations .....	24
4.5 Matlab Simulation .....	30
4.6 Experiment Conclusion .....	34
5. COMPARISON BETWEEN LED AND BULB ILLUMINATION .....	36
5.1 Lifetime Comparison .....	37
5.2 Wavelength Comparison .....	38
5.3 Advantages of LED's .....	39
5.4 Market Forecast .....	40
6. CONCLUSIONS .....	42
REFERENCES .....	R1
APPENDICESY:	
A. Matlab Illumination Simulator Code .....	A1
B. Matlab Code, Approximation to Radius .....	A2

## LIST OF TABLES

Table 1.1: Improvement in LED Technology .....	3
Table 2-1: LED Color Chart .....	7
Table 3.1: Symbols used in Figure 3.8.....	15
Table 4.1: 124W, 30 degree HPLED projector's measured values in experiment in TCDD, Ankara .....	22
Table 4.2: 1000W normal projector values in experiment in TCDD, Ankara.....	23
Table 4.3: Parameters used in equation 4.1 .....	24
Table 4.4: Calculated values via simulator .....	33
Table 5.1: LED vs Bulb Comparison Table.....	36
Table 5-2: Lifetime comparison of different illumination technics.....	37

## LIST OF FIGURES

Figure 1.1: Experiment with Silicon Carbide .....	1
Figure 1.2: A graph of the I–V characteristics of a carborundum detector indicating the onset of light emission, published by Losev .....	2
Figure 2.1: Inside of an LED.....	4
Figure 2.2: Inner workings of an LED.....	5
Figure 2.3: Low Power LED .....	8
Figure 2.4: High Power LED .....	9
Figure 3.1: Wind turbines used for indoor LED lighting, Nairobi, Kenya .....	10
Figure 3.2: Wind turbines in Bahrain World Trade Center, Bahrain.....	11
Figure 3.3: Road illumination with solar panel as energy source.....	12
Figure 3.4: Garden illumination with solar panel as energy source.....	12
Figure 3.5: General schema of LED illumination system using solar panel.....	13
Figure 3.6: LED illumination under DC Current.....	14
Figure 3.7: LED illumination under PWM Current.....	15
Figure 3.8: Some traffic signs using LED.....	16
Figure 3.9: Wall Washer .....	17
Figure 3.10: LEDs with different angles.....	18
Figure 3.11: LED light source for spot on a statue .....	19
Figure 3.12: LED light source used for area illumination.....	19
Figure 3.13: Illumination area of a light source consisted of mixed type LEDs .....	20
Figure 4.1: Schema of HPLED illumination system in TCDD, Ankara.....	21
Figure 4.2: Measuring the light with luxmeter in TCDD, Ankara.....	23
Figure 4.3: Calculating radius .....	26
Figure 4.4: : Radius vs. $\sigma$ approximation .....	27
Figure 4.5: Illumination density graph, z in Lux, x in meters, y in meters.....	30
Figure 4.6: Illumination density graph, z in Lux, x in meters.....	31

Figure 4.7: Illumination density graph, x and y in meters .....	31
Figure 4.8: Illumination density graph, x in meters, y in meters .....	32
Figure 5.1: Output energy as a function of wavelength for an incandescent bulb .....	38
Figure 5.2: Emission spectrum of a white LED .....	39
Figure 5.3: Moore's law of sorts .....	41
Figure 5.4: LED Market Forecast .....	41

GCCRIS

## CHAPTER 1

### INTRODUCTION

A light-emitting-diode (LED) is a special diode that emits light when an electric current is applied in the forward direction of the device. The effect is a form of electroluminescence where incoherent and narrow-spectrum light is emitted from the p-n junction[1].

LEDs are conventionally used as indicators in control panels, and also for light sources in low power optic communication applications. Recently, high power and more efficient LED has appeared on the market. This improvement in LED sector not only changed traditional illumination styles, but also changed both people life and commercial habits.

#### 1.1 History

In history, first report of a LED was made in 1907 by a British experimenter, H. J. Round in Marconi Labs. He noticed electroluminescence produced from a crystal of silicon carbide in an experiment. We can see how silicon carbide emits light in Figure 1.1[2].

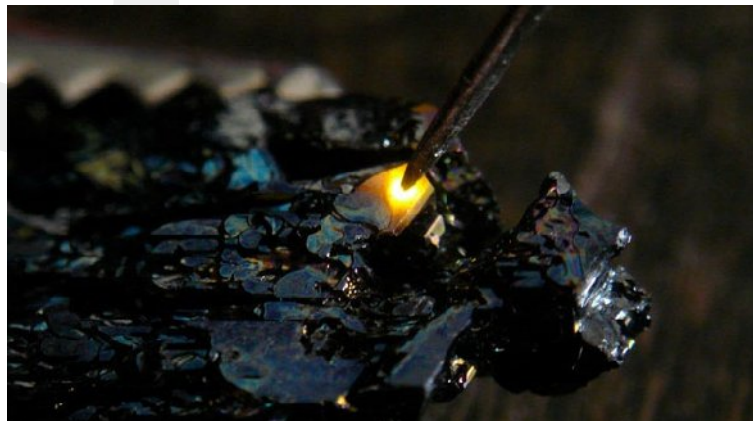

Figure 1.1: Experiment with Silicon Carbide

In 1920s, a Russian experimenter, Oleg Vladimirovich Losev independently created the first LED. Although his research(Figure 1.2)[3] was distributed in Russian, German and British scientific journals, his research was ignored, and there was not any practical improvement in LED sector for following 30-40 years.[3]

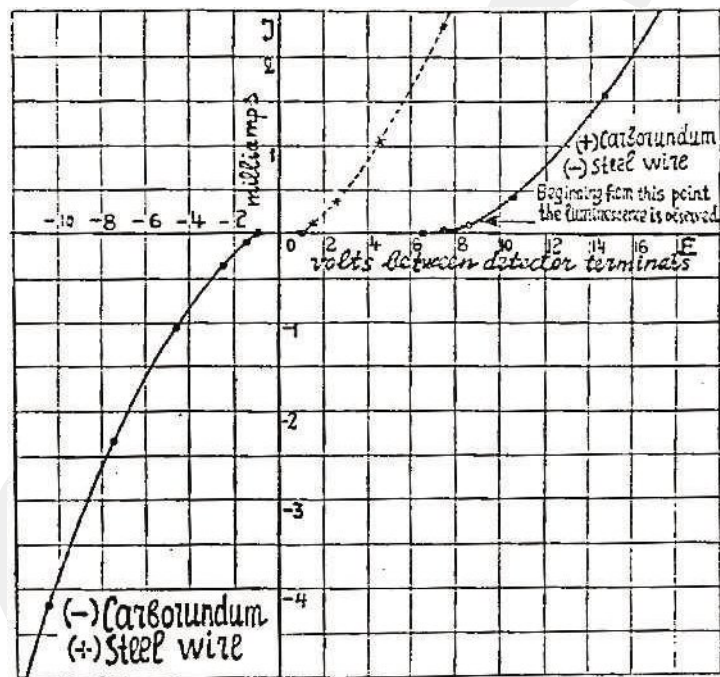

Figure 1.2 A graph of the I–V characteristics of a carborundum detector indicating the onset of light emission, published by Losev

In 1955, Rubin Braunstein working in Radio Corporation of America, reported on infrared emission from gallium arsenide (GaAs) and other semiconductor composites. Braunstein observed infrared emission generated by simple diode at room temperature.

In 1961, experimenters Bob Biard and Gary Pittman from the Texas Instruments(TI) found that gallium arsenide radiated in infrared spectrum when electricity was applied. Biard and Pittman received the patent for the infrared LED (light-emitting diode).

In 1962, The LED in red color was invented by Nick Holonyak. It was the first LED that gives light in visible-spectrum(red). At that time he was working for General Electric Company but he later moved to the University of Illinois at Urbana-Champaign. Holonyak is called as "father of the light-emitting diode"[4]. M. George Craford, a former graduate student of Holonyak's, invented the first yellow LED and ten times brighter red and red-orange LEDs in 1972. White LED is invented in 1995 by Nakamura. In Table 1.1[5], we can see the development of LED through history.

Table 1.1 Improvement in LED Technology

<b>Year</b>	<b>Improvement in LED Technology</b>
<b>1907</b>	Light Emitting Solid
<b>1955</b>	Infrared LED
<b>1962</b>	Red LED
<b>1972</b>	Yellow LED
<b>1972</b>	Amber LED
<b>1993</b>	Blue LED
<b>1995</b>	White LED

## CHAPTER 2

### LED TECHNOLOGY

LED is a still growing technology in both lighting and also in communication. In this chapter we will examine how LED works and LED technology.

#### 2.1 How LED Works

A LED is a special diode that emits light when an electric current is applied in the forward direction of the device. The effect is a form of electroluminescence where incoherent and narrow-spectrum light is emitted from the p-n junction.

Like a normal diode, the LED consists of a chip of semiconducting material impregnated, or doped, with impurities to create a p-n junction. As in other diodes, current flows easily from the p-side, or anode, to the n-side, or cathode, but not in the reverse direction. In Figure 2.1[6], inside of a LED is shown.

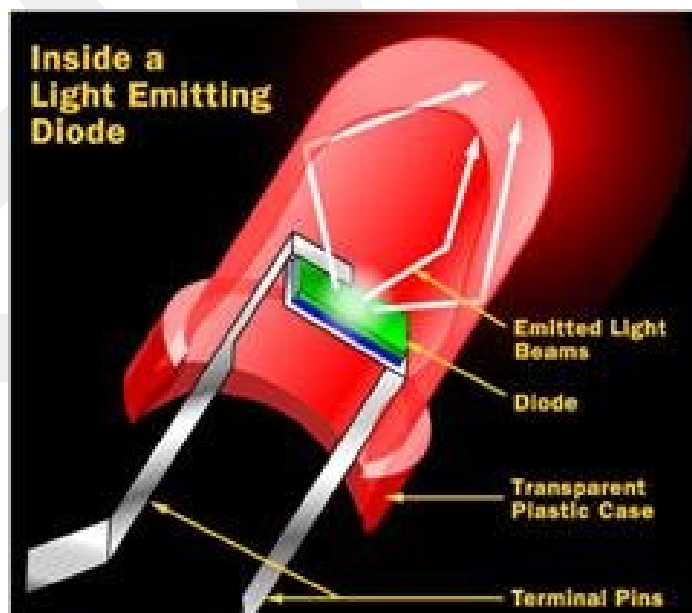

Figure 2.1 Inside of an LED

The reason that effect the color of LED is, when sufficient voltage is applied to the chip across the leads of the LED, electrons can move easily in only one direction across the junction between the p and n regions. In the p region there are many more positive than negative charges. In the n region the electrons are more numerous than the positive electric charges. When a voltage is applied and the current starts to flow, electrons in the n region have sufficient energy to move across the junction into the p region. Once in the p region the electrons are immediately attracted to the positive charges due to the mutual Coulomb forces of attraction between opposite electric charges. When an electron moves sufficiently close to a positive charge in the p region, the two charges "re-combine". (Figure 2.2)[1]

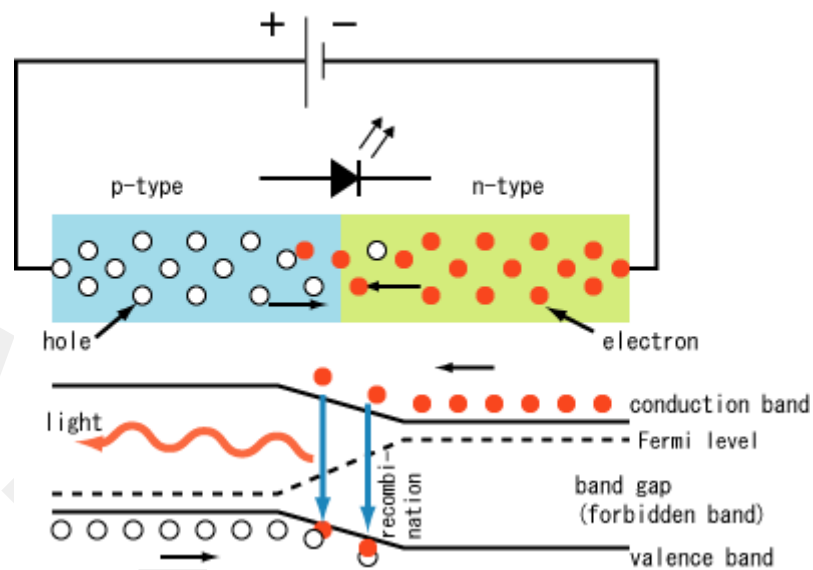

Figure 2.2 Inner workings of an LED

Each time an electron recombines with a positive charge, electric potential energy is converted into electromagnetic energy. For each recombination of a negative and a positive charge, a quantum of electromagnetic energy is emitted in the form of a photon of light with a frequency characteristic of the semi-conductor material (usually a combination of the chemical elements gallium, arsenic and phosphorus).

Only photons in a very narrow frequency range can be emitted by any material. LED's that emit different colors are made of different semi-conductor materials, and require different energies to light them.

Wavelengths, colors, opening voltages and materials can be seen in the Table 2-1[7].

## 2.2 Wavelength of LED

We can calculate wavelength by using the below formula in Equation 2.1.

$$\lambda = hc / E_g \quad (2.1)$$

Where;

- $\lambda$  : wavelength
- $h$  : Planck constant
- $c$  : speed of light
- $E_g$  : energy space

Example:

For instance, let us examine (GaAs) (Equation 2.2)

$$\begin{aligned} E_g &= 1.49eV \\ 1eV &= 1.602 \times 10^{-19} \text{ joule} \\ h &= 6.6262 \times 10^{-34} \text{ Js} \\ c &= 2.99793 \times 10^8 \text{ m/s} \\ \lambda &= hc / E_g \\ \lambda &= 8.322 \times 10^{-7} \text{ m} \\ \lambda &= 832 \text{ nm} \end{aligned} \quad (2.2)$$

However, this wavelength is in infrared part of spectrum.

Table 2-1: LED Color Chart

Wavelength (nm)	Color Name	Fwd Voltage (Vf @ 20ma)	Intensity 5mm LEDs @50mA	Viewing Angle	LED Dye Material
940	Infrared	1.5	16mW @50mA	15°	GaAIAs/GaAs
880	Infrared	1.7	18mW @50mA	15°	GaAIAs/GaAs
850	Infrared	1.7	26mW @50mA	15°	GaAIAs/GaAs
660	Ultra Red	1.8	2000mcd @50mA	15°	GaAIAs/GaAs
635	High Eff. Red	2.0	200mcd @20mA	15°	GaAsP/GaP - Gallium Arsenic Phosphide / Gallium Phosphide
633	Super Red	2.2	3500mcd @20mA	15°	InGaAIP - Indium Gallium Aluminum Phosphide
620	Super Orange	2.2	4500mcd @20mA	15°	InGaAIP - Indium Gallium Aluminum Phosphide
612	Super Orange	2.2	6500mcd @20mA	15°	InGaAIP - Indium Gallium Aluminum Phosphide
605	Orange	2.1	160mcd @20mA	15°	GaAsP/GaP - Gallium Arsenic Phosphide / Gallium Phosphide
595	Super Yellow	2.2	5500mcd @20mA	15°	InGaAIP - Indium Gallium Aluminum Phosphide
592	Super Pure Yellow	2.1	7000mcd @20mA	15°	InGaAIP - Indium Gallium Aluminum Phosphide
585	Yellow	2.1	100mcd @20mA	15°	GaAsP/GaP - Gallium Arsenic Phosphide / Gallium Phosphide
4500K	"Incandescent" White	3.6	2000mcd @20mA	20°	SiC/GaN -- Silicon Carbide/Gallium Nitride
6500K	Pale White	3.6	4000mcd @20mA	20°	SiC/GaN -- Silicon Carbide/Gallium Nitride
8000K	Cool White	3.6	6000mcd @20mA	20°	SiC/GaN - Silicon Carbide / Gallium Nitride
574	Super Lime Yellow	2.4	1000mcd @20mA	15°	InGaAIP - Indium Gallium Aluminum Phosphide
570	Super Lime Green	2.0	1000mcd @20mA	15°	InGaAIP - Indium Gallium Aluminum Phosphide
565	High Efficiency Green	2.1	200mcd @20mA	15°	GaP/GaP - Gallium Phosphide/Gallium Phosphide
560	Super Pure Green	2.1	350mcd @20mA	15°	InGaAIP - Indium Gallium Aluminum Phosphide
555	Pure Green	2.1	80mcd @20mA	15°	GaP/GaP - Gallium Phosphide/Gallium Phosphide
525	Aqua Green	3.5	10,000mcd @20mA	15°	SiC/GaN - Silicon Carbide / Gallium Nitride
505	Blue Green	3.5	2000mcd @20mA	45°	SiC/GaN - Silicon Carbide / Gallium Nitride
470	Super Blue	3.6	3000mcd @20mA	15°	SiC/GaN - Silicon Carbide / Gallium Nitride
430	Ultra Blue	3.8	100mcd @20mA	15°	SiC/GaN - Silicon Carbide / Gallium Nitride

## 2.3 LED Types

LEDs can be categorised generally in two groups. These are “Low Power LEDs” and “High Power LEDs”.

### 2.3.1 Low Power LEDs

These are the conventional LEDs used that are used as indicators. However nowadays they are also used in lighting applications. They can be in various-sizes. Both through-hole and surface mount packages are available in market.

Most common packages available in market are SMD, 2 mm, 3 mm (T1), 5 mm (T1<sup>3/4</sup>), 10 mm LEDs.

We can categorise Low Power LEDs in three groups with respect to current they use. Low current LEDs typically rated for 2 mA at around 2 V. They have approximately 4 mW consumption.

Standard LEDs uses 20 mA LEDs at around 2 V and they consume approximately 40 mW for red, orange, yellow & green, and 20 mA at 4–5 V, that means approximately 100 mW, for blue, violet and white.

Ultra-high output LEDs uses 20 mA at approximately 2 V or 4–5 V. They are designed for viewing in direct sunlight. This kind of “white” LEDs can be also used in lighting. A low power LED is shown in Figure 2.5[1].

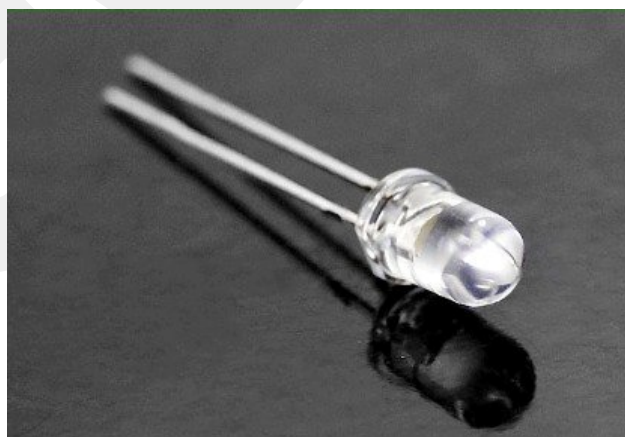

Figure 2.3: Low Power LED

### 2.3.2 High Power LEDs

High power LEDs (HPLED) can be driven at hundreds of mA (vs. tens of mA for other LEDs), some with more than one ampere of current, and give out large amounts of light. Since overheating is destructive, the HPLEDs must be highly efficient to minimize excess heat; furthermore, they are often mounted on a heat sink to allow for heat dissipation. If the heat from a HPLED is not removed, the device will burn out in seconds.

A single HPLED can often replace an incandescent bulb in a flashlight, or be set in an array to form a powerful LED lamp. A high power LED can be seen in Figure 2.6[8].



Figure 2.4: High Power LED

## CHAPTER 3

### LED APPLICATIONS

The only limit of inventing new systems using LED's is human mind. There are lots of systems using LED technology and there will be more in the future. In this chapter we will only examine the most critical inventions using LED that brought ease in our daily life.

#### 3.1 Renewable Energy Sources For LED Illumination Systems

Since LED is a technology that uses so low energy to illuminate, alternative voltage sources can be used to give needed energy to LED system such as **wind turbines** or **solar panels**. These renewable energy sources reduce the management cost. They also help us to protect our nature from hazardous effects of unrenovable energy sources.

##### 3.1.1 Wind Turbines As Energy Source

It is known that wind turbines are used in LED illumination systems as voltage sources in some African countries and other poor countries[9]. A photo is shown in Figure 3.1[9] of Nairobi, Kenya.



Figure 3.1: Wind turbines used for indoor LED lighting, Nairobi, Kenya

Wind turbines are also used in new technological architectures, skyscrapers such as Bahrain World Trade Center. This application can be seen in Figure 3.2[10].



Figure 3.2: Wind turbines in Bahrain World Trade Center, Bahrain

There are three bridges connecting the towers; each holding one large wind turbine with a nameplate capacity of 225kW each, totalling to 675kW of wind energy production[10]. The wind turbines are expected to provide 11% to 15% of the towers' total power consumption, or approximately 1.1 to 1.3 GWh a year. This is equivalent to providing the lighting for about 300 homes annually.[11]

### 3.1.2 Solar Panels As Energy Source

Solar panels are also used as energy sources for LED illumination systems especially outdoor illumination systems. These kind of systems not only easy to setup, but also useful at places where it is hard to bring electricity.

The main advantage of the system is it does not require periodic maintenance. Once system is installed, it will illuminate over 100.000 hours (27 years, 10 hour/day) without any cost of electricity. A solar-powered LED street lamp can be seen at Figure 3.3[12]



Figure 3.3: Road illumination with solar panel as energy source

Since the system is easy to setup, they are generally used in road/street illumination and lighting gardens and parks. (Figure 3.4)[12]



Figure 3.4: Garden illumination with solar panel as energy source

To examine closely this solar panelled LED illumination system, we have to look into the main parts.

The System is consisted of three main parts: (Figure 3.5)[13]

- Power / Electricity Unit
  - Solar Panel
  - Rechargeable Battery
  - DC/DC Converter
- Active Unit
  - Light Sensor
  - Programmable Microcontroller
  - LED Driver Unit
- LED System

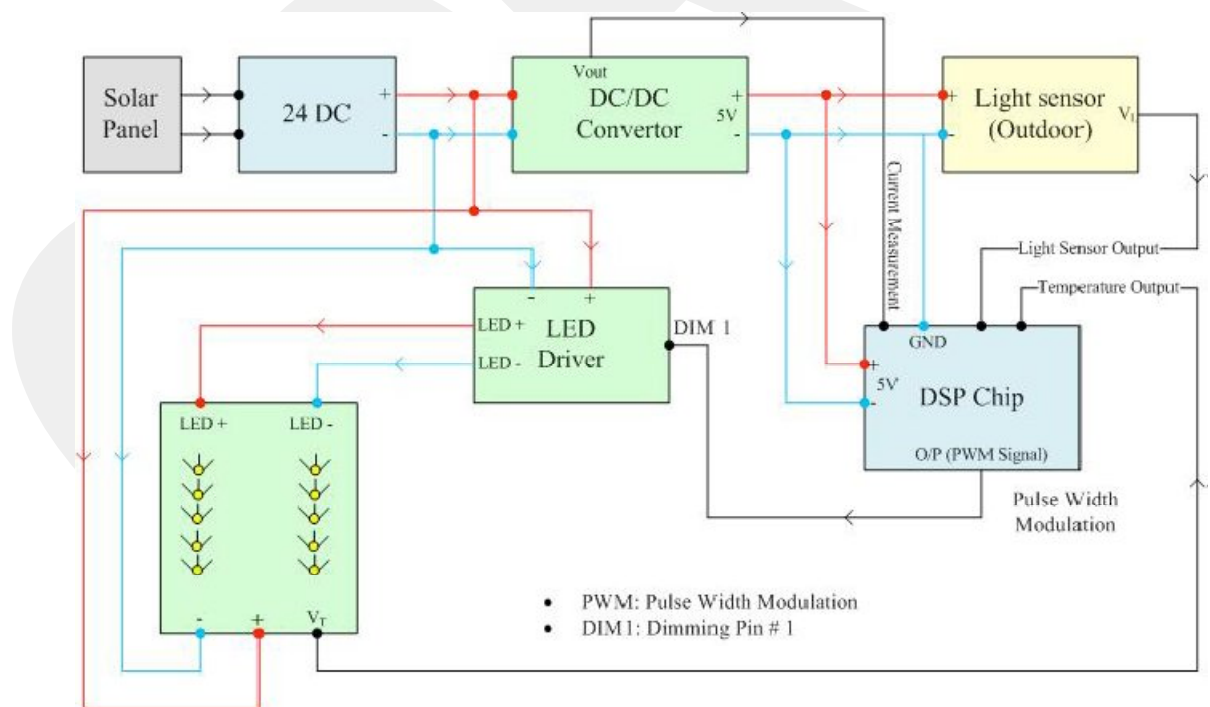

Figure 3.5: General schema of LED illumination system using solar panel

The principle of the above system is;

- Solar panel gets the energy from the sun and this energy is stored in 24V or 12V battery
- Voltage is reduced to 5V to run microcontroller and light sensor
- Microcontroller checks if it is dark or not by using light sensor
- If it is not dark, microcontroller sends OFF STATE SIGNAL to LED driver circuit so that LEDs stay off.
- If it is dark, it sends a PWM signal to LED Driver circuit
- Density of light can be changed by changing frequency and duration of PWM signal
- LEDs are come to ON state by the signal sent by LED driver circuit.

In Figure 3.6 DC signal, that can be applied over LED is shown. In Figure 3.7[14] we can examine PWM signal to control LED. Thus, difference between DC signal and PWM signal is compared after figures.

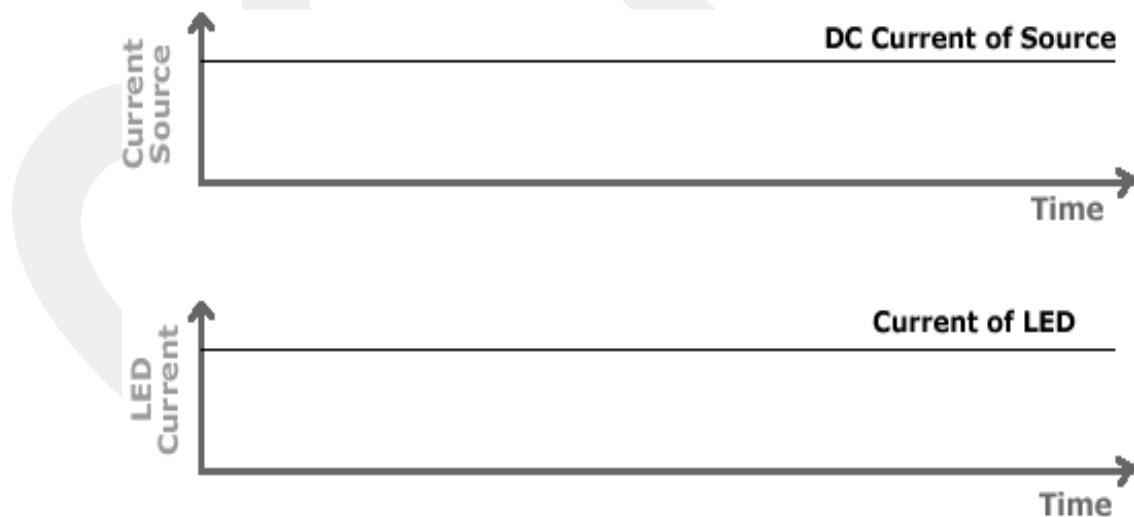

Figure 3.6: LED illumination under DC Current

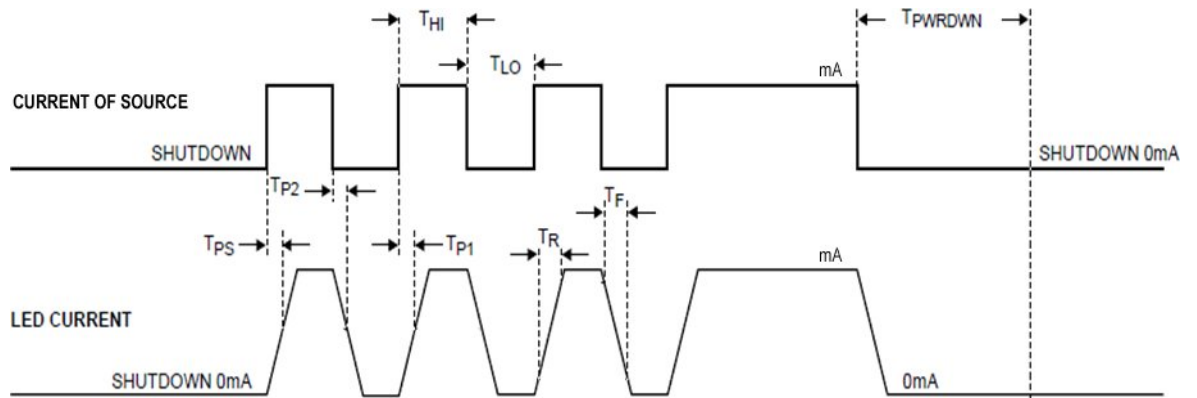

Figure 3.7: LED illumination under PWM Current

Symbols used in Figure 3.7[14] can be seen in Table 3.1.

Table 3.1: Symbols used in Figure 3.8

Symbol	Name
$T_{PS}$	Turn-On time, EN/PWM rising to $I_{LED}$ from Shutdown
$T_{P1}$	Turn-On time, EN/PWM rising to $I_{LED}$
$T_{P2}$	Turn-Off time, EN/PWM falling to $I_{LED}$
$T_R$	LED rise time
$T_F$	LED fall time
$T_{LO}$	EN/PWM low time
$T_{HI}$	EN/PWM high time
$T_{PWDRWN}$	EN/PWM low time to shutdown delay

As shown in Figure 3.7;

Let TLO be the low time of PWM (pulse width modulation) signal and THI be high time of PWM signal. THI plus TLO gives us the period of our pwm signal.

If TLO is equal to period, this means THI is zero, there would be no illumination. If THI is equal to period, there would be a dc current over LED. [134]

Main advantage of using PWM, dimming is easy. Analog dimming control is that changes brightness by changing LED's forward current. The PWM dimming control is that changes brightness by modulating LED's forward current between 0% and 100%. That is LED brightness controlled by adjusting the relative ratios of the on time and the off time. So in PWM, forward current is constant, by the way LED's color does not vary with brightness.[15]

### 3.2 Traffic Signs

Solar traffic signs can undertake a vital function in a modern, advanced traffic management system. These signs are strongly illuminated and therefore easy to read, making them much more suitable for their purpose of ensuring the attention of road users. In addition, of course, they have the considerable benefit of helping to conserve energy because of their environmentally conscious solar technology[16]. In figure 3.8[16] there are some traffic signs using LED.



Figure 3.8: Some traffic signs using LED

Main advantages of using LED in traffic signs are it reduces energy cost up to 90% compared to incandescent lamps and animations can be done to get clarity.

### 3.3 Wall Washers

LED wall washer is mainly used for decoration and highlight in building frame, garden, etc. It can work in independent mode and automatic mode, which can generate various color changing effects, such as flashing, fading, steady ,seven color jumping synchronously etc. [17] (Figure 3.9)



Figure 3.9: Wall Washer

Wallwashing is a popular name for a lighting technique for illumination of large surfaces. By using these devices, a building's color can be changed to any color or change continuously. It is most popular in malls, trade centers and in modern architecture, such as museums or cultural public buildings.

### 3.4 Choosing The LED in Different Applications

In illumination using LED it is important to select the right kind of LED according to needs. The main factor defines the type of illumination is angle of LED. (Figure 3.10[18])

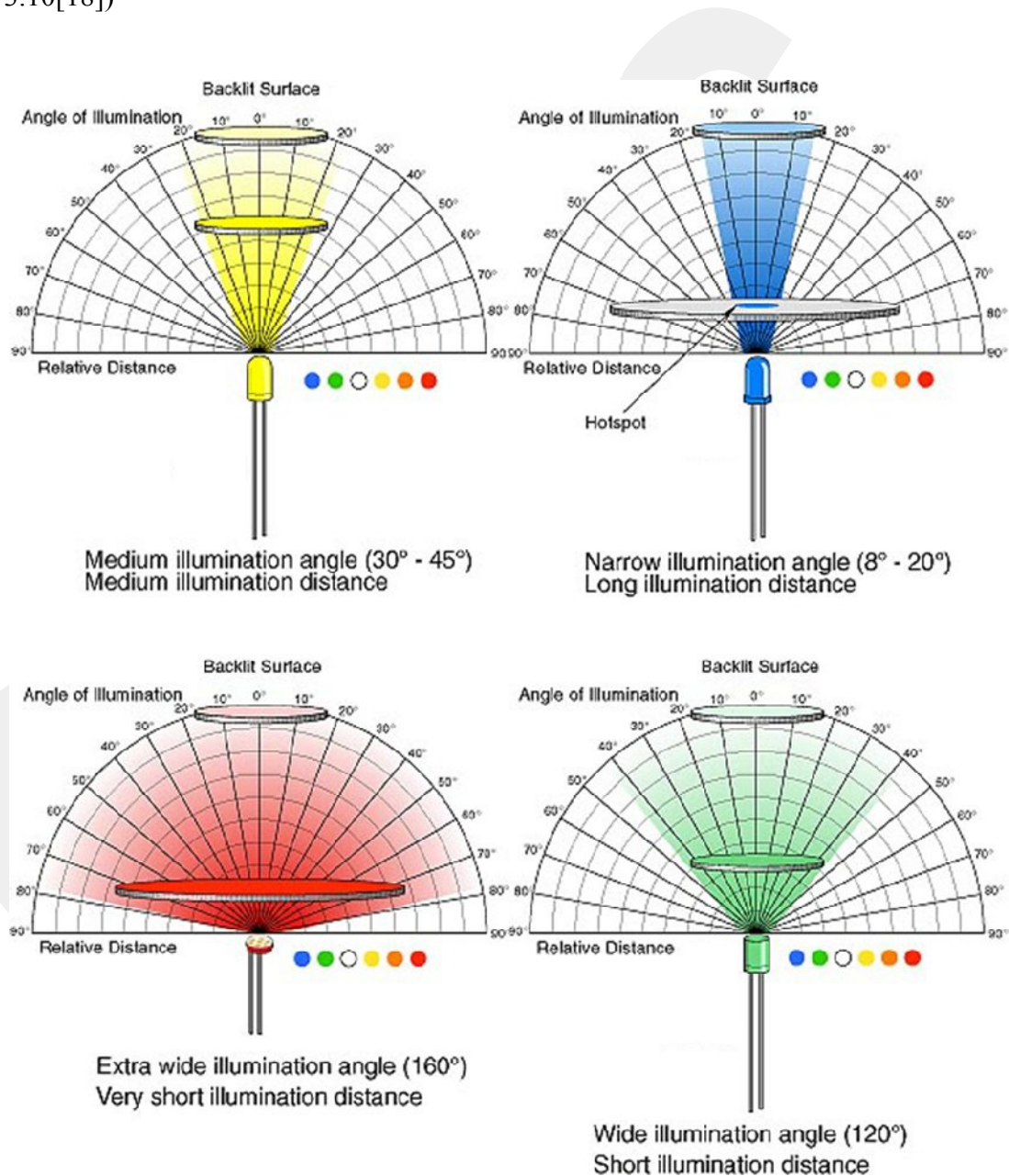

Figure 3.10: LEDs with different angles

Generally to spot on an object such as statue, fountain or a banner, narrow angled LEDs should be selected like in the Figure 3.11.

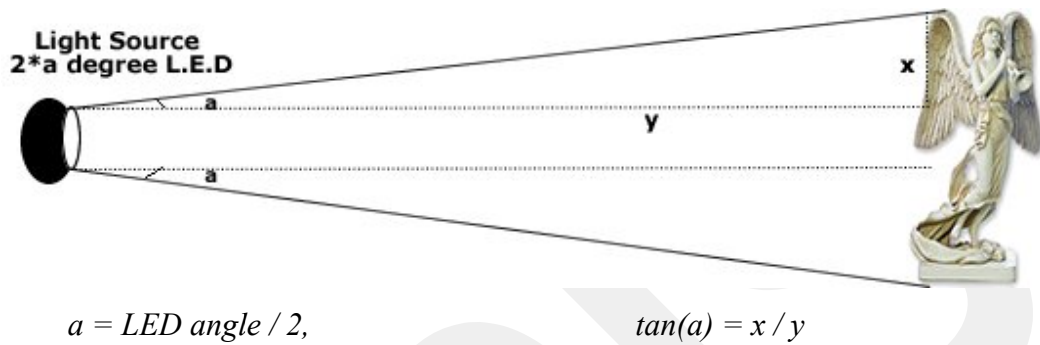

Figure 3.11: LED light source for spot on a statue

In Figure 3.11;

Let  $a$  be the half of the LED angle. Let  $x$  be approximately radius of the area we want to illuminate. Since  $\tan(a) = x / y$ ,  $a$  and  $x$  is known, so that  $y$  can be found by the formula.

To illuminate large areas such as gardens, roads etc. wider angled LEDs should be chosen such as in the example shown in Figure 3.12

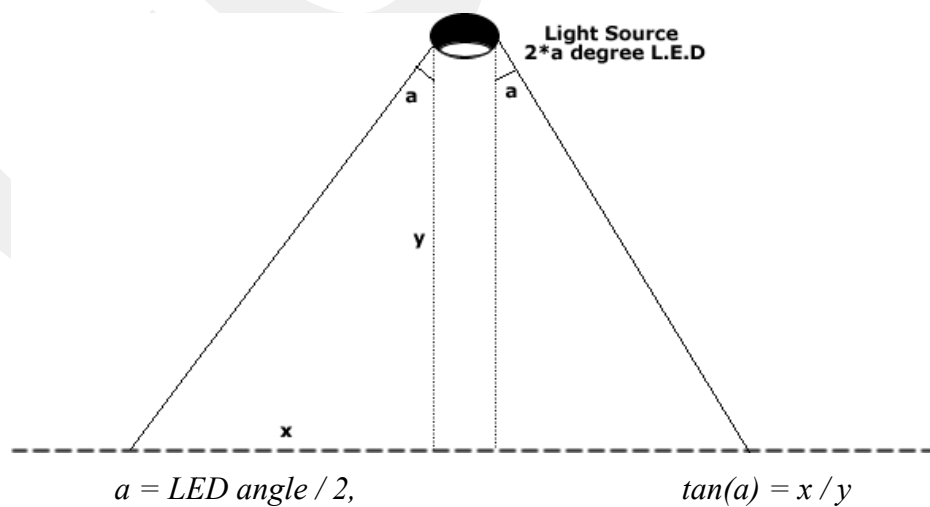

Figure 3.12: LED light source used for area illumination

In Figure 3.12;

Let  $\alpha$  be the half of the LED angle. Let  $y$  be the height of the point that light source is held. Since  $\tan(\alpha) = x / y$ ,  $\alpha$  and  $y$  is known, so that  $x$ , in other words radius of the area that can be illuminated, can be found by the formula.

In some cases both types of LEDs (narrow angle and wide angle LEDs) can be used in the same application. In those cases a weak spot effect can be seen in illumination area. The area is called as weak spot region because spot effect can be seen by looking at illumination area however when it is compared with a narrow angled LED light source, it is seen that illumination of spot area is weaker in mixed kind LED light source. (Figure 3.14)

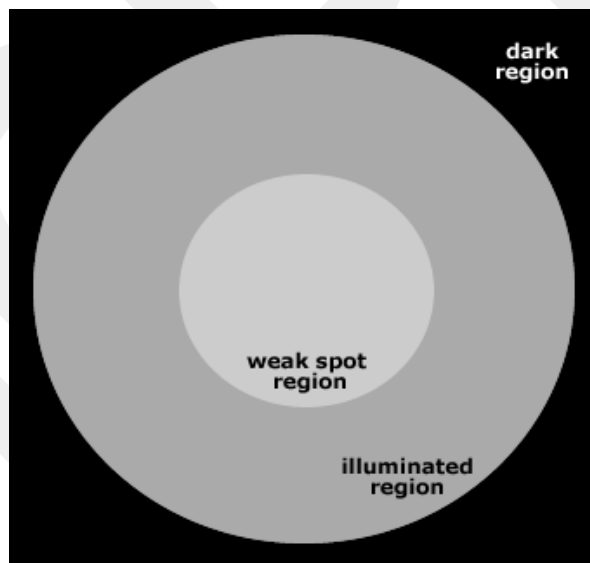

Figure 3.13: Illumination area of a light source consisted of mixed type LEDs

## CHAPTER 4

### HPLED OUTDOOR ILLUMINATION EXPERIMENT

#### 4.1 Experiment Introduction

In this chapter we will examine the experiment about HPLED outdoor illumination systems and compare it with traditional projectors. Since there were both 1000W normal projector and 124W HPLED projector in TCDD garden, measurements were done there, to make easier to compare the results.

#### 4.2 Experiment Overview

In figure 4.1, there is general schema of illumination system with HPLED

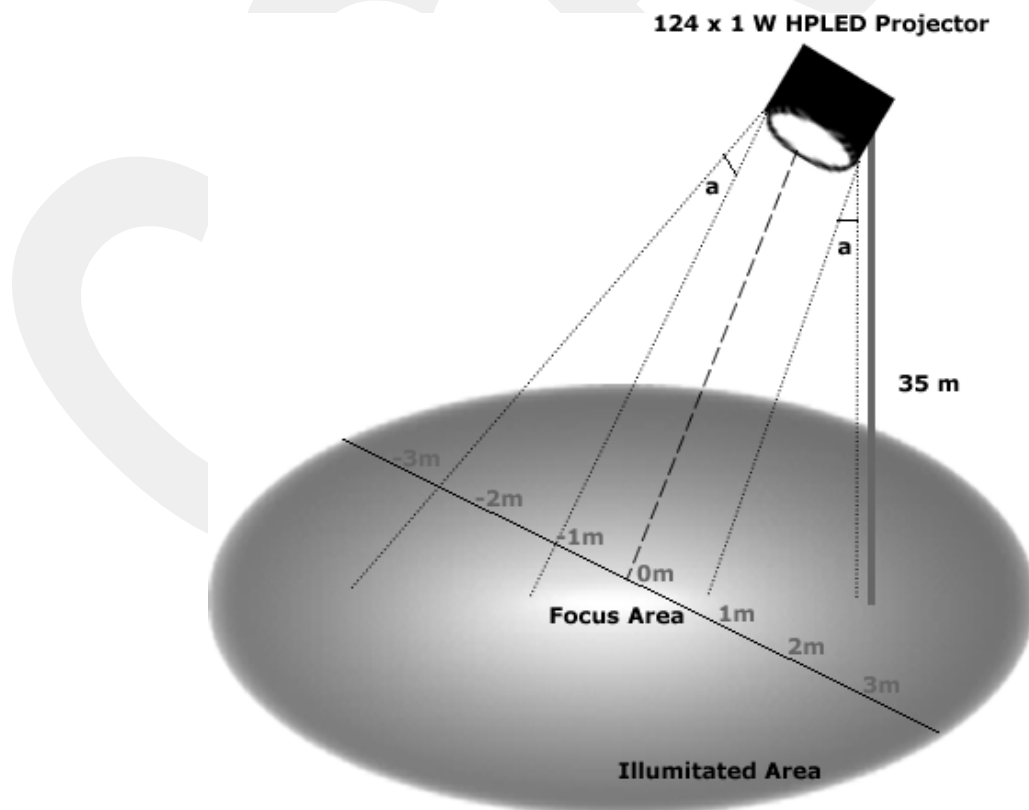

Figure 4.1: Schema of HPLED illumination system in TCDD, Ankara

In experiments, it is seen that, the maximum value is observed in “Focus Area”, and it decreases while going straight through a radius. It is also observed that illumination power in the area has a function of similar to gaussian function.[19]

### 4.3 Measurement

In Table 4.1 we can see the observed values in luxmeter using 124W 30 degree HPLED projector. We accepted focus area as 0 point and moved through positive and negative directions.

Table 4.1: 124W, 30 degree HPLED projector’s measured values in experiment in TCDD, Ankara

<b>Coordinate</b>	<b>Illumination Power(Lux)</b>
<b>-4 meters</b>	39
<b>-3 meters</b>	56
<b>-2 meters</b>	77
<b>-1 meter</b>	94
<b>0</b>	102
<b>1 meter</b>	94
<b>2 meters</b>	78
<b>3 meters</b>	57
<b>4 meters</b>	38



Figure 4.2: Measuring the light with luxmeter in TCDD, Ankara

In Table 4.2 we can see the values of 1000W normal projector, having the same height with previous experiment.

Table 4.2: 1000W normal projector values in experiment in TCDD, Ankara

<b>Coordinate</b>	<b>Illumination Power(Lux)</b>
<b>-4 meters</b>	11.4
<b>-3 meters</b>	12.1
<b>-2 meters</b>	12.5
<b>-1 meter</b>	13.2
<b>0</b>	14.1
<b>1 meter</b>	13.1
<b>2 meters</b>	12.6
<b>3 meters</b>	12
<b>4 meters</b>	11.4

#### 4.4 Mathematical Approximations

Since gaussian function is already observed in illumination area, we can formulate it as a gaussian function. Formula of a gaussian function is shown in equation 4.1. In Table 4.3 we can see explanations of symbols used in equation 4.1[19][20].

$$z=f(x,y)=Ae^{-\frac{(x-x_0)^2}{2\sigma_x^2}-\frac{(y-y_0)^2}{2\sigma_y^2}} \quad (4.1)$$

Table 4.3: Parameters used in equation 4.1

Symbol	Explanation
f(x,y)	Gaussian function related to x and y[19]
A	Amplitude of Gaussian Function
$\sigma^2$	Variance
E	$\sim=2.718281828$ (Euler's number)[21]
$x_0$	Mean in x axis
$y_0$	Mean in y axis

LED projector's dimensions, that is used in this application, are 40 x 40 cm. Since its dimensions are so small with respect to the illumination area, it is acceptable as a point source. Let  $\sigma_x^2$  be the variance in x axis and  $\sigma_y^2$  be the variance in y axis of our gaussian function. Since the variances should be equal, we get the formula shown in equation 4.2.

$$\sigma_x^2 = \sigma_y^2 = \sigma^2 \quad (4.2)$$

A point should be taken as  $x=0$  and  $y=0$  (zero point) to do this experiment. To calculations easier, we accepted the center of the focus area as zero point. We found the zero point by doing measurement with luxmeter. Zero point is the point where the luxmeter shows the maximum value among measured values. This maximum value is accepted as our A (Amplitude of Gaussian Function)(Table 4.3). By help of this, we centered the zero point to gaussian functions maximum point, with no slide. So we can figure out the result in equation 4.3.

$$x_0 = 0, y_0 = 0 \quad (4.3)$$

Let B be a parameter related to  $\sigma^2$  (Equation 4.4).

$$B = \frac{1}{2\sigma^2} \quad (4.4)$$

Thus, the formula is simplified into equation 4.5.

$$z = A e^{-B(x^2+y^2)} \quad (4.5)$$

In equation 4.5;

- A (Amplitude of Gaussian Function) should be in Lux, and it is equal to maximum value, that is read by luxmeter, under illumination area.
- B is a constant
- $x^2$  and  $y^2$  are in meters.

Let r be radius of illumination area in meters, h be distance from light source to ground, a be half of the angle used of LEDs, used in light source. In figure 4.3 we can see the prototype of this system. We can also see the relation among a(angle), r and h in equation 4.6.

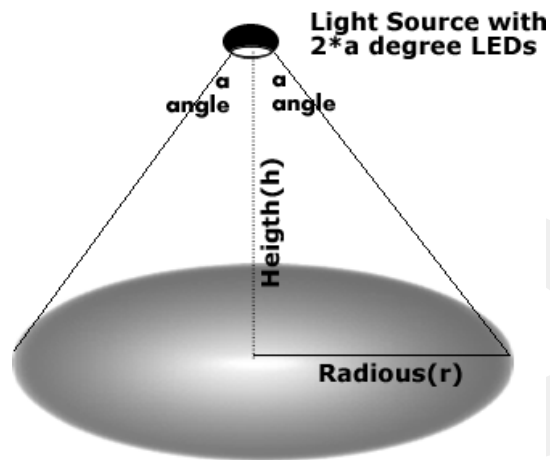

Figure 4.3: Calculating radius

$$\tan(a)=r/h \tag{4.6}$$

To make some mathematical approaches to relation between radius and  $\sigma$ , we examine gaussian function two dimensionally. The formula is given in equation 4.7 for 2D Gaussian Function.[22]

$$y=Ae^{-\frac{1}{2\sigma^2}(x^2)} \tag{4.7}$$

In equation 4.7, A is amplitude constant and  $\sigma$  is variance of gaussian function. In figure 4.4[23] a 2D Gaussian Function is shown.

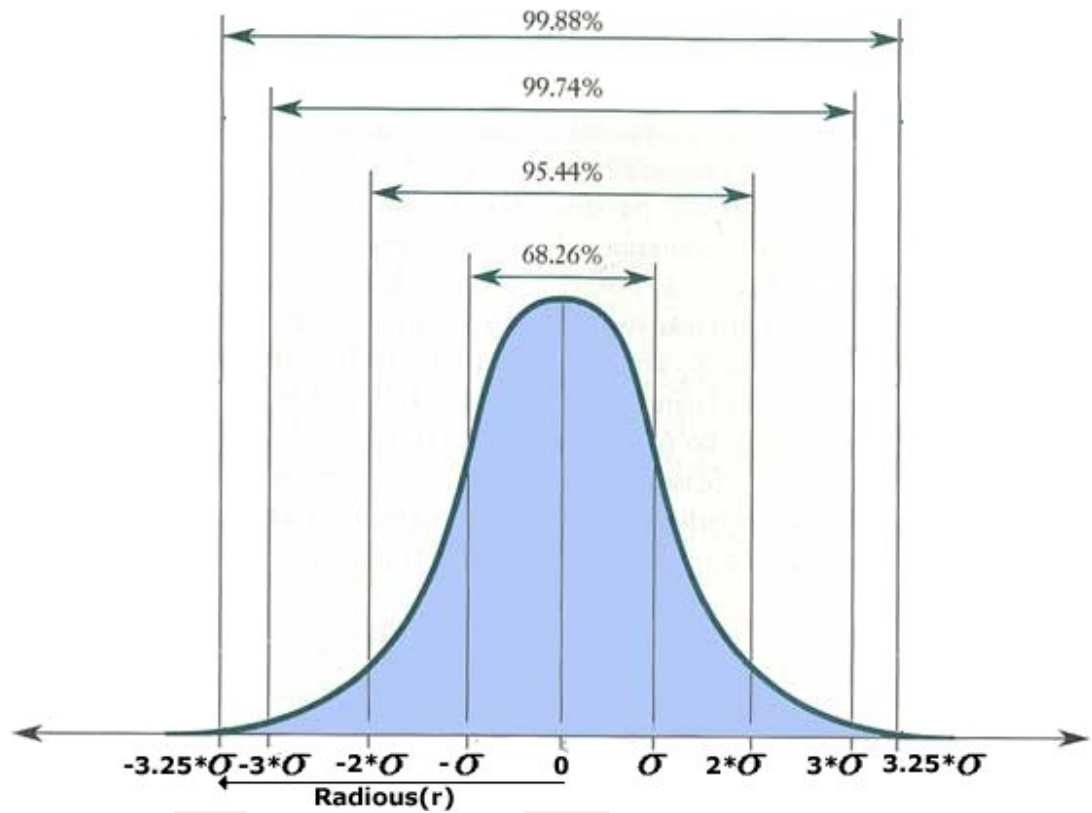

Figure 4.4: Radius vs.  $\sigma$  approximation

Also integral ratios are shown on top of figure. Integral ratios are explained in equation 4.8, equation 4.9, equation 4.10 and equation 4.11. In these figures, we are trying to find integral limits which can be enough to represent the whole space.

$$\frac{\int_{-\sigma}^{\sigma} A e^{-\frac{1}{2\sigma^2}(x^2)} dx}{\int_{-\infty}^{\infty} A e^{-\frac{1}{2\sigma^2}(x^2)} dx} = 0.6826 \quad (4.8)$$

Equation 4.8 means that, the ratio of integral of gaussian function from  $-\sigma$  to  $\sigma$ , to integral of gaussian function in whole x space is 0,6826. So  $\sigma$  cannot represent the whole space in this condition.

$$\frac{\int_{-2\sigma}^{2\sigma} A e^{-\frac{1}{2\sigma^2}(x^2)} dx}{\int_{-\infty}^{\infty} A e^{-\frac{1}{2\sigma^2}(x^2)} dx} = 0.9544 \quad (4.9)$$

Equation 4.9 means that, the ratio of integral of gaussian function from  $-2\sigma$  to  $2\sigma$ , to integral of gaussian function in whole x space is 0,9544. So  $2\sigma$  also cannot represent the whole space in this application.

$$\frac{\int_{-3\sigma}^{3\sigma} A e^{-\frac{1}{2\sigma^2}(x^2)} dx}{\int_{-\infty}^{\infty} A e^{-\frac{1}{2\sigma^2}(x^2)} dx} = 0.9974 \quad (4.10)$$

Equation 4.10 means, the ratio of integral of gaussian function from  $-3\sigma$  to  $3\sigma$ , to integral of gaussian function in whole x space is 0,9974. 0,9974 is close to 1 but our approximation would be better if we get the result more close to 1.

$$\frac{\int_{-3.25\sigma}^{3.25\sigma} A e^{-\frac{1}{2\sigma^2}(x^2)} dx}{\int_{-\infty}^{\infty} A e^{-\frac{1}{2\sigma^2}(x^2)} dx} = 0.9988 \cong 1 \quad (4.11)$$

Equation 4.11 means that, the ratio of integral of gaussian function from  $-3,25\sigma$  to  $3,25\sigma$ , to integral of gaussian function in whole x space is 0,9988. 0,9988 is enough close to 1. So we can accept our radius as  $3,25\sigma$ .

These calculations can be found in Appendix II.

$$r \cong 3.25\sigma \quad (4.12)$$

By using equation 4.6 and equation 4.12, we get the result shown in equation 4.13.

$$\sigma \cong (\tan(a)h)/3.25 \quad (4.13)$$

The gaussian function, that is simplified for this application is shown in equation 4.14

$$z = Ae^{-\frac{1}{2\sigma^2}(x^2+y^2)} \quad (4.14)$$

- A is measured with luxmeter
- a (angle of LED) is known by looking the device's datasheet(equation 4.13)
- h is known by measuring distance between source and ground(equation 4.13)
- $\sigma$  is calculated by using a and h

Thus, we found everything to run a matlab simulation

#### 4.5 Matlab Simulation

We also implemented a simulator code in Matlab designed by using equation 4.14 and got the shown results in figure 4.5, figure 4.6, figure 4.7, figure 4.8.

In this simulation; we got height as 35 meters, a (angle) as 15 degrees, and A (amplitude) as 102 Lux, which is measured by luxmeter.(Equation 4.15)

$$\begin{aligned} h &= 35m \\ a &= \frac{\pi}{12} \\ A &= 102Lux \end{aligned} \quad (4.15)$$

Thus, by using equation 4.13, we calculated  $\sigma$  as the value shown in equation 4.16.

Matlab code for this simulation can be seen at Appendix I.

$$\sigma \cong 2.8856 \quad (4.16)$$

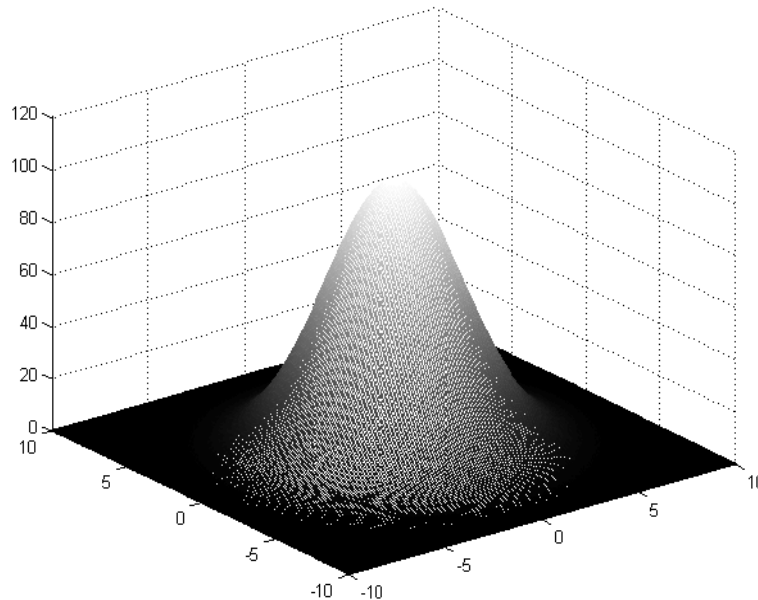

Figure 4.5: Illumination density graph, z in Lux, x in meters, y in meters

In figure 4.5, there is a mesh graph of output of simulation. The 3D output graph shows illumination density along z axis in lux. x and y axes are in meters.

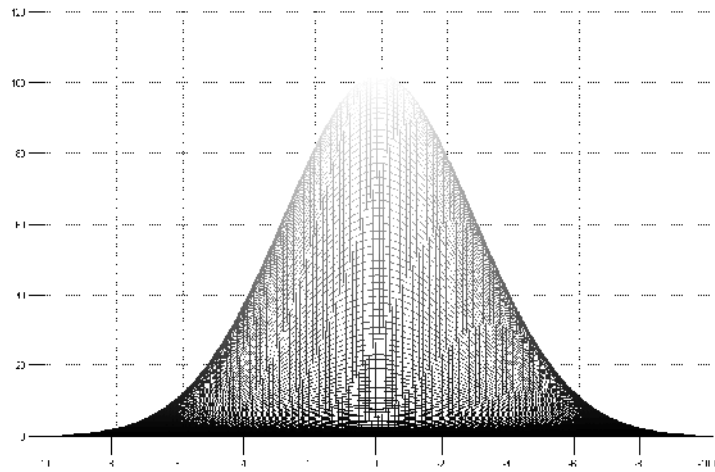

Figure 4.6: Illumination density graph, z in Lux, x in meters

Figure 4.6 is the same graph with figure 4.5. The difference between those graphs is point of view. In this point of view, we can only see x and z axes as a 2D graph.

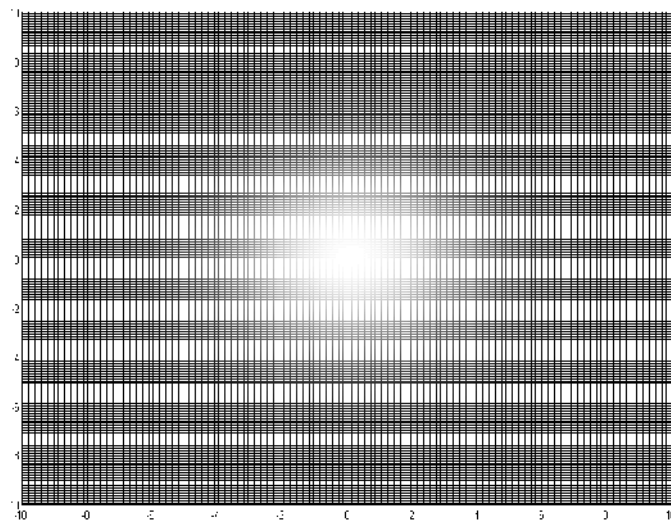

Figure 4.7: Illumination density graph, x and y in meters

Figure 4.7 is the same graph with figure 4.5 and figure 4.6. In this point of view, we are looking the same graph from the top of it. We can only see x and y axes as a 2D graph and z is shown as color. The lighter points show the more illuminated areas.

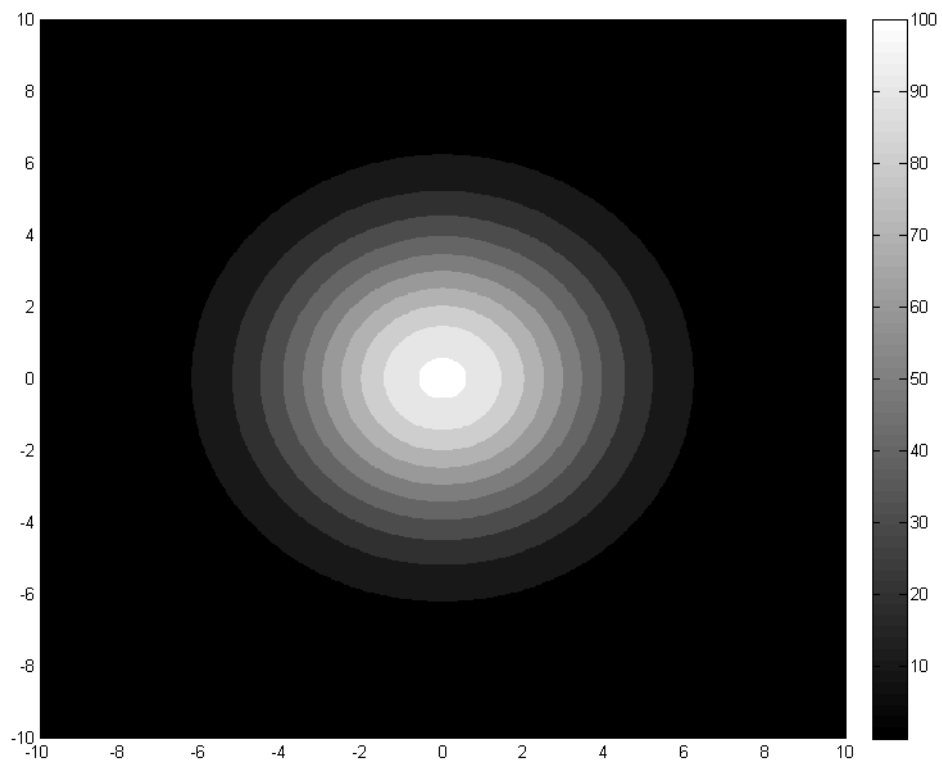

Figure 4.8: Illumination density graph, x in meters, y in meters

In figure 4.8, we see the illumination density graph. This graph is similar to figure 4.7. It is also like a screenshot from top of the gaussian function shown in figure 4.5 and figure 4.6.

Light places show more illuminated areas, darker places mean less illuminated areas. There is also scale at right of the figure 4.7, that shows which tone of gray implies which lux value.

In table 4.4 some results from experiment is shown. We can compare it with table 4.1.

Table 4.4: Calculated values via Simulator

<b>Coordinate</b>	<b>Simulation Output(Lux)</b>
<b>-5 meters</b>	21.7155
<b>-4 meters</b>	37.7116
<b>-3 meters</b>	58.0091
<b>-2 meters</b>	78.5380
<b>-1 meter</b>	94.1235
<b>0</b>	102
<b>1 meter</b>	94.1235
<b>2 meters</b>	78.5380
<b>3 meters</b>	58.0091
<b>4 meters</b>	37.7116
<b>5 meters</b>	21.7155

When table 4.4 compared to table 4.1, we can see that values shown at same points are either equal or too close to each other.

Hence, we can say that our experiment and simulation are successfull.

Matlab simulation code can be found in Appendix I for this experiment.

## 4.6 Experiment Conclusion

In this experiment we measured the illumination density values (in Lux) of a 1000W traditional projector and a 124W,30 degree, HPLED projector.

We also made a mathematical approximation to run a matlab simulation of the illumination caused by any LED projector. We compared the simulations result and the measured values, and we saw that either they are equal or so close.

We should also compare the results between 1000w traditional projector and 124W HPLED projector. Consumed power ratio of the projectors can be seen in equation 4.17.

$$\frac{1000W}{124W} = 8,0645 \quad (4.17)$$

As it is seen in equation 4.17, that 1000W projector uses 8 times more energy then the HPLED projector.

Illumination ratio in focus area of the projectors is shown in equation 4.18.

$$\frac{14.1Lux}{102Lux} = 0.1382 \quad (4.18)$$

However in focus area, as it seen in equation 4.18, traditional projector illuminates as low as 1/7 of HPLED projector. We calculated watt per lux ratio in equation 4.19 and equation 4.20.

The power required by HPLED to illuminate 1 lux in focus area is shown in equation 4.19

$$\frac{124W}{102Lux} = 1.21W / Lux \quad (4.19)$$

Power required by 1000W projector to illuminate 1 lux in focus area can be seen in equation 4.20

$$\frac{1000W}{14.1Lux} = 70.92W / Lux \quad (4.20)$$

If we talk about efficiency, HPLED projector uses 1.21W to illuminate 1 lux as it is seen in equation 4.19, on the other hand, normal projector uses approximately 70.92W to illuminate 1 lux which can be seen in equation 4.20, in focus area.

$$\frac{70.92W / Lux}{1.21W / Lux} = 58.61 \quad (4.21)$$

Only by looking this 124W HPLED projector is 58 times efficient than 1000W traditional projector. (Equation 4.21)

## CHAPTER 5

### COMPARISON BETWEEN LED AND BULB ILLUMINATION

The main topics we can compare LED vs. bulb are;

- What are their average lifetimes?
- Is failure mode predictable?
- Are their lifetimes affected by on/off operation?
- Are they resistant to shock or vibration?
- Are their operation temperatures high or low?
- Are their power consumptions high or low?
- Are their initial investments high or low?
- What are their operating wavelengths?

Answers to these questions are given in Table 5.1.

Table 5.1: LED vs Bulb Comparison Table

	LED	Bulb
Average Life	50,000 hours	2,000 hours
Failure Mode	Predictable	Unpredictable
Lifetime affected by on/off operation	No	Yes
Resistant to shock and vibration	Yes	No
Operating temperature	Low	High
Power consumption	Low	High
Initial Investment	High	Low

## 5.1 Lifetime Comparison

The lifetimes of traditional light sources are rated through established test procedures. For example, CFLs are tested according to LM-65, published by the Illuminating Engineering Society of North America (IESNA). A statistically valid sample of lamps is tested at an ambient temperature of 25° Celsius using an operating cycle of 3 hours ON and 20 minutes OFF. The point at which half the lamps in the sample have failed is the rated average life for that lamp. For 10,000 hour lamps, this process takes about 15 months.

Full life testing for LEDs is impractical due to the long expected lifetimes. Switching is not a determining factor in LED life, so there is no need for the on-off cycling used with other light sources. But even with 24/7 operation, testing an LED for 50,000 hours would take 5.7 years. Because the technology continues to develop and evolve so quickly, products would be obsolete by the time they finished life testing.

The IESNA is currently developing a life testing procedure for LED products, based in part on the ASSIST recommends approach. The proposed method involves operating the LED component or system at rated current and voltage for 1,000 hours as a “seasoning period.” This is necessary because the light output actually increases during the first 1,000 hours of operation, for most LEDs. Then the LED is operated for another 5,000 hours. The radiant output of the device is measured at 1,000 hours of operation; this is normalized to 100%. Measurements taken between 1,000 and 6,000 hours are compared to the initial (1,000 hour) level (Table 5.2)[24]

Table 5.2: Lifetime comparison of different illumination technics

Light Source	Range of Typical Rated Life (hours)*
Incandescent	750-2,000
Halogen incandescent	3,000-4,000
Compact fluorescent (CFL)	8,000-10,000
Metal halide	7,500-20,000
Linear fluorescent	20,000-30,000
High-Power White LED	35,000-50,000

## 5.2 Wavelength Comparison

Another comparison between bulb vs. LED can be made by comparing their wavelength spectrum. It is known that LED has a narrow frequency spectrum with respect to bulbs. In figure 5.1 and figure 5.2, the difference of frequency spectrum between bulb and LED can be observed.

In figure 5.1[25], there is output energy as a function of wavelength for an incandescent bulb.

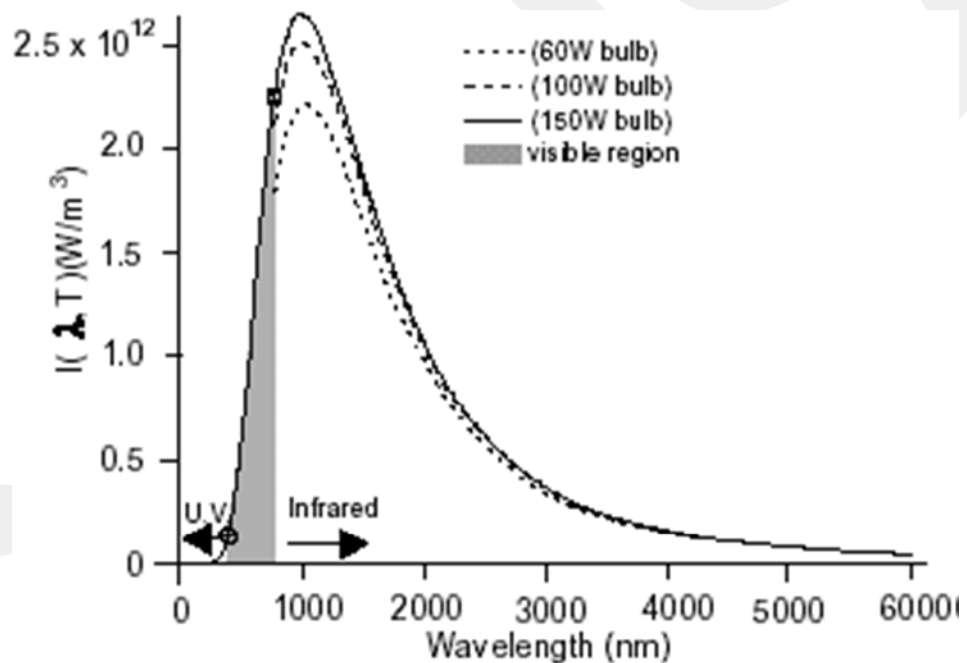

Figure 5.1: Output energy as a function of wavelength for an incandescent bulb

As it is seen in Figure 5.1; while using bulb for illumination, bandwidth is so large, even covering invisible regions more than visible regions. That means, much of its energy is used for giving light in invisible spectrum and, in other words, most of energy is lost.

In Figure 5.2, there is emission spectrum of phosphor-based white LED.

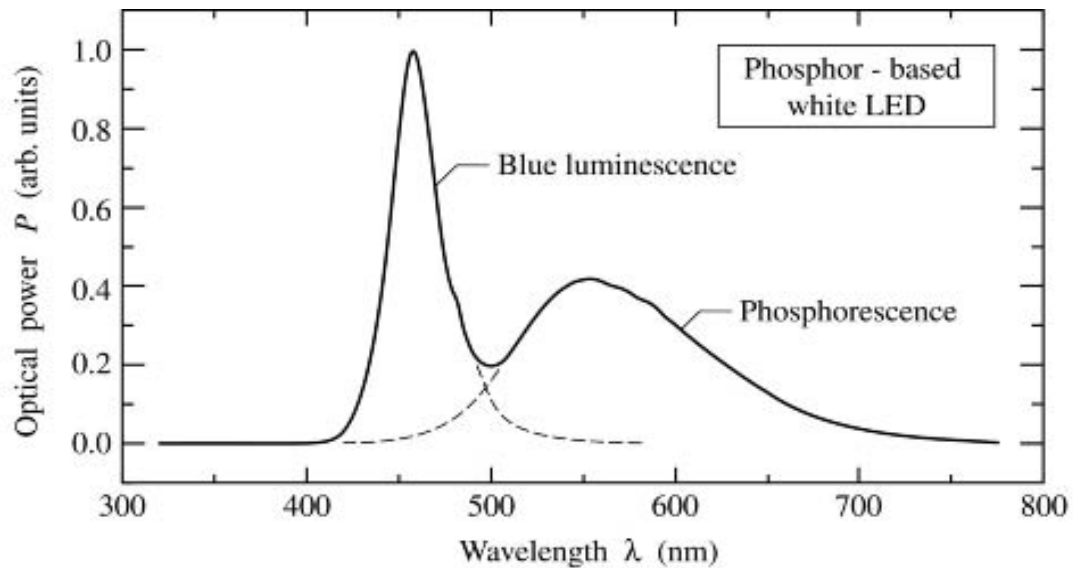

Figure 5.2: Emission spectrum of a white LED

As it seen in figure 5.2[26]; using white LED in illumination, has a narrow bandwidth and wavelengths are in visible spectrum. That means the energy given to LED only used to emit light in visible spectrum, hence no energy loss for the invisible spectrum.

### 5.3 Advantages of using LEDs

- Efficiency: LEDs produce more light per watt than incandescent bulbs; this is useful in battery powered or energy-saving devices. (chapter 4.4)
- Color: LEDs can emit light of an intended color without the use of color filters that traditional lighting methods require. This is more efficient and can lower initial costs.
- Size: LEDs can be very small ( $>2 \text{ mm}^2$ ) and are easily populated onto printed circuit boards.
- On/Off time: LEDs light up very quickly. A typical red indicator LED will achieve full brightness in microseconds. LEDs used in communications devices can have even faster response times.

- **Cycling:** LEDs are ideal for use in applications that are subject to frequent on-off cycling, unlike fluorescent lamps that burn out more quickly when cycled frequently, or HID lamps that require a long time before restarting.
- **Dimming:** LEDs can very easily be dimmed either by Pulse-width modulation or lowering the forward current.
- **Slow failure:** LEDs mostly fail by dimming over time, rather than the abrupt burn-out of incandescent bulbs.
- **Lifetime:** LEDs can have a relatively long useful life. The report [24] estimates 35,000 to 50,000 hours of useful life, though time to complete failure may be longer. Fluorescent tubes typically are rated at about 30,000 hours, and incandescent light bulbs at 1,000–2,000 hours.
- **Shock resistance:** LEDs, being solid state components, are difficult to damage with external shock, unlike fluorescent and incandescent bulbs which are fragile.
- **Focus:** The solid package of the LED can be designed to focus its light. Incandescent and fluorescent sources often require an external reflector to collect light and direct it in a usable manner.
- **Toxicity:** LEDs do not contain mercury unlike fluorescent lamps.

#### **5.4 Market Forecast**

LED market is ready for accelerated growth in lighting, display backlights and automotive applications.

LED technology seems to be following a Moore's law of sorts; a plot of efficiency over the past four decades (shown in Figure 5.3[27]) reveals that efficiency seems to be improving by a factor of 30x per decade whereas cost per lumen seems to be reducing by a factor of 1/10x per decade.

Extrapolation of this data demonstrates what industry experts have been predicting; by ~2010 LEDs will be efficient and cost effective enough to replace fluorescents for general lighting.

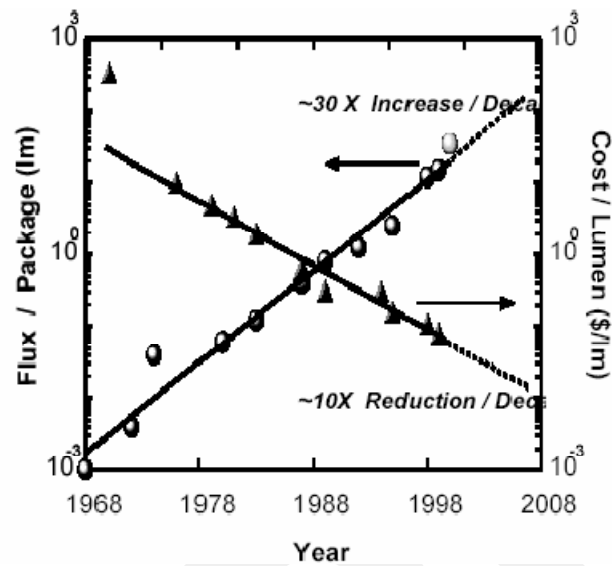

Figure 5.3: Moore's law of sorts

Another new study is out, this one from Strategies Unlimited projecting LED lighting will become a \$1.5 billion category by 2012. They note that in 2007, the LED lighting sector was \$325 million, mainly “architectural lighting” which takes to mean decorative types of effects since they state “the ability of LEDs to provide colors and color-changing effects was a major market driver.”[28].(Figure 5.4[27])

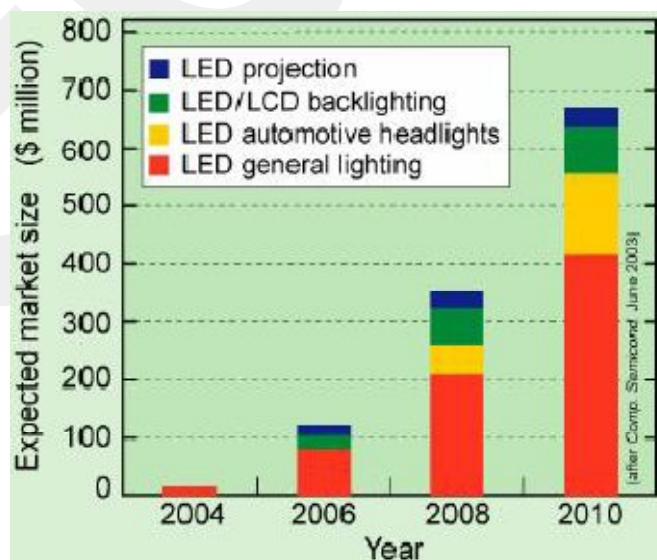

Figure 5.4: LED Market Forecast

## CHAPTER 6

### CONCLUSIONS

Demand for electricity grows with an exponential rate in today's global world; the need for electricity increases rapidly as a result of industrial developments, technological advancements and improvements in life-style conditions. Electrical energy is widely used in every aspect of our lives, and accounts for the 25% of the energy used for our lighting needs. Although the requirement for electricity is crucial, yet electrical energy is far away from being a cost-effective energy source. Growing need for efficient and cost-effective energy sources has led researchers to seek renewable energy sources. The importance of renewable energy sources and their role in impeding a potential energy crisis have been emphasized in various research projects. Renewable energy sources are expected to make positive contributions to environmental issues and to prevent a possible disruption of energy supplies.

In this study, we have examined the characteristics of Light Emitting Diodes and compared this technology with Traditional Projectors in order to verify the efficiency, cost-effectiveness and environmentality of this relatively new Lighting (Illumination) technology. After reviewing the history of LED and the current trends in this technology, an experiment is designed to gather illumination power data for both HPLED and regular projectors. The obtained data are used to calculate illumination density in the next step. In order to find density, a new mathematical approximation is formulated, which is based on Gaussian function, and embedded in a simulation code to plot an illumination density graph and to provide a better understanding of the current comparison.

Previous research in this field of study have already shown us the inefficiency of incandescent bulbs. The amount of energy loss from these kinds bulbs is incredibly high compared to LED due to the high levels of bandwidth usage. On the other side, LED illumination is a relatively new technology and has plenty of room for development. Lifetime expectancy tests of LED indicated that LED has almost a 6 times higher lifetime value than incandescent bulbs. Our own experiment results also showed that, LED is able to provide up to eight times better efficiency than the traditional 1000W projectors. Again based on our findings, It is recommended to use solar panels in compliance with LED technology to replace the traditional electric supplies.

The increasing numbers of LED usage led us to conclude that LED technology will continue to spread and eventually become a widely accepted lighting (illumination) source. Rapid evolution of this technology in the last 15 years, can be a good indicator to show its yet unleashed potential.

Some of the future research in this field can be concentrated on the lux intensity. The current lux intensity may not be enough to fulfill the illumination in larger and wider areas. We know that, as the distance from the light source grows, intensity weakens in a considerable amount. Therefore, It is quite reasonable to focus the future research efforts on improving the lux intensity and the other factors related to this subject. It is also recommended to do further research on reflecting elements. Their support on lux intensity should be examined carefully.

The main contribution of this current study is to analyze a newly-introduced illumination source and make empirical comparisons with a widely used energy source to determine its effectiveness. The results we obtained and the other on-going research efforts have clearly showed that LED technology will take the place of traditional light sources in the near future.

## REFERENCES

- [1] [http://en.wikipedia.org/wiki/Light-emitting\\_diode](http://en.wikipedia.org/wiki/Light-emitting_diode) (2009)
- [2] [http://blog.makezine.com/archive/2008/11/make\\_presents\\_the\\_led\\_a\\_m.html](http://blog.makezine.com/archive/2008/11/make_presents_the_led_a_m.html) (2009)
- [3] ZHELUDEV N., (2007), *The life and times of the LED — a 100-year history*, University of Southampton, UK.
- [4] [http://en.wikipedia.org/wiki/Nick\\_Holonyak\\_Jr.](http://en.wikipedia.org/wiki/Nick_Holonyak_Jr.) (2009)
- [5] [http://www.refraction.net/Question/LED/LED\\_history.php](http://www.refraction.net/Question/LED/LED_history.php) (2009)
- [6] [http://www.remuen.ch/ledstuff/led02\\_ledbasics.htm](http://www.remuen.ch/ledstuff/led02_ledbasics.htm) (2009)
- [7] <http://www.hudnut.com/ledcolors.htm> (2009)

- [8] [http://www.lakewoodconferences.com/direct/dbimage/50215051/High\\_Power\\_LED\\_Lamp.jpg](http://www.lakewoodconferences.com/direct/dbimage/50215051/High_Power_LED_Lamp.jpg) (2009)
- [9] THOMAS B.,(2007) *A Wind Powered, White LED Lighting System for the Kibera Slum of Nairobi*, Baylor University, Texas
- [10] [http://en.wikipedia.org/wiki/Bahrain\\_world\\_trade\\_center](http://en.wikipedia.org/wiki/Bahrain_world_trade_center) (2009)
- [11] <http://www.reuters.com/article/gc07/idUSL1928644820070319> (2007)
- [12] <http://www.agfelectronics.com/EN/Products/Lighting.asp> (2009)
- [13] Al-Sulaiti S, et. al., (2008) *Solar Led Lights*
- [14] Catalyst Semiconductor, Inc. ,(2008) *CAT4101 (datasheet)*, Santa Clara, CA
- [15] [http://www.starchips.com.tw/pdf/led\\_driver\\_an/](http://www.starchips.com.tw/pdf/led_driver_an/) (2009)
- [16] [http://www.solar-street-lighting.com/Solar\\_Traffic\\_Signs.html](http://www.solar-street-lighting.com/Solar_Traffic_Signs.html) (2009)
- [17] <http://www.karnar.com> (2009)

- [18] [http://www.oksolar.com/led/led\\_color\\_chart.htm](http://www.oksolar.com/led/led_color_chart.htm) (2009)
- [19] [http://en.wikipedia.org/wiki/Gaussian\\_function](http://en.wikipedia.org/wiki/Gaussian_function) (2009)
- [20] <http://retina.anatomy.upenn.edu/~lance/modelmath/gaussian.html> (1995)
- [21] [http://en.wikipedia.org/wiki/E\\_\(mathematical\\_constant\)](http://en.wikipedia.org/wiki/E_(mathematical_constant)) (2009)
- [22] <http://hyperphysics.phy-astr.gsu.edu/Hbase/math/gaufcn.html> (2009)
- [23] <http://curvebank.calstatela.edu/gaussdist/gaussdist.htm> (2009)
- [24] Gordon K., (2006), *Lifetime of White LEDs*, US Department of Energy, US
- [25] SEBITOSI A.B., PILLAY P. (2003), *White LEDs for Rural Lighting*,  
University of Cape Town
- [26] <http://www.ecse.rpi.edu/~schubert/Light-Emitting-Diodes-dot-org/chap21/chap21.htm> (2009)

[27] Al-Jadda, O., (2004), *LED Lighting in the ΔDelta SmartHouse*, Duke University Pratt School of Engineering

[28] *High-Brightness LED: Market Review and Forecast 2008 (Ninth Edition)*, Strategies Unlimited, California

GCPRIS

## APPENDIX A

### MATLAB ILLUMINATION SIMULATOR CODE

```
clear;
A = 102; %maksimum ölçülen lüks miktarı
alfa = pi/12; % üzerindeki ledin açısı / 2
height = 35; %aydınlatma direğinin uzunluğu
% tan(alfa) = Aydınlanacak alan yarıçapı / height
radius = tan(alfa) * height;
%radius yaklaşık 3.25 * sigma kadardır (yaklaşım)
sigma = radius / 3.25
B = 1/(2*sigma^2)
x = linspace(-10,10,200);
y = linspace(-10,10,200);

for n=1:200
    for m=1:200
        z(n,m) = A*exp(-B.*((x(n)).^2+(y(m)).^2));
    end
end

meshc(x,y,z);
pause;
colormap gray;
pause;
contourf(x,y,z,'EdgeColor','none')
colorbar
```

## APPENDIX B

### MATLAB CODE, APPROXIMATION TO RADIUS

```
sigma=1
```

```
A=1
```

```
B = 1/(2*sigma^2)
```

```
F = @(x)A*exp(-B.*(x).^2)
```

```
r_full = quadl(F,-10*sigma,10 * sigma);
```

```
r1 = quadl(F,-1 * sigma,1 * sigma);
```

```
r2 = quadl(F,-2 * sigma,2 * sigma);
```

```
r3 = quadl(F,-3 * sigma,3 * sigma);
```

```
r3_25 = quadl(F,-3.25 * sigma,3.25 * sigma);
```

```
r1 / r_full
```

```
r2 / r_full
```

```
r3 / r_full
```

```
r3_25 / r_full
```