



**EFFICIENT PHASE ROTATION TECHNIQUES IN PAPR REDUCTION OF  
OFDM SYMBOLS**

**WISAM HASAN ALI**

**APRIL 2017**

EFFICIENT PHASE ROTATION TECHNIQUES IN PAPR REDUCTION OF  
OFDM SYMBOLS

A THESIS SUBMITTED TO  
THE GRADUATE SCHOOL OF NATURAL AND APPLIED SCIENCES OF  
CANKAYA UNIVERSITY

BY  
WISAM HASAN ALI

IN PARTIAL FULLFILLMENT OF THE REQUIREMENTS  
FOR  
THE DEGREE OF MASTER OF SCIENCE  
IN  
THE DEPARTMENT OF  
ELECTRONICS AND COMMUNICATION ENGINEERING

APRIL 2017

Title of the Thesis : **Efficient Phase Rotation Techniques in PAPR Reduction of OFDM Symbols**

Submitted by **Wisam Hasan ALI**

Approval of the Graduate School of Natural and Applied Sciences, Çankaya University

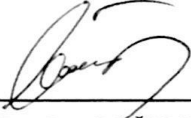
  
\_\_\_\_\_  
Prof. Dr. Can ÇOĞUN

Director

I certify that this thesis satisfies all the requirements as a thesis for the degree of Master of Science.

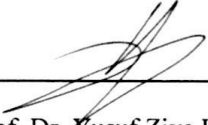
  
\_\_\_\_\_  
Prof. Dr. Yusuf Ziya UMUL  
Head of Department

This is to certify that we have read this thesis and that in our opinion it is fully adequate, in scope and quality, as a thesis for the degree of Master of Science.

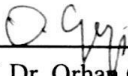
  
\_\_\_\_\_  
Assoc. Prof. Dr. Orhan GAZİ

Supervisor



**Examination Date: 27.04.2017**

**Examination Committee Members:**

Prof. Dr. Halil T. EYYUBOĞLU (Çankaya Univ.)

Assoc. Prof. Dr. Orhan GAZİ (Çankaya Univ.)

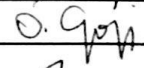
Assist. Prof. Dr. Javad RAHABI (T.Aeronautical Assoc. Univ.)

  
\_\_\_\_\_  
  
\_\_\_\_\_  
  
\_\_\_\_\_

### STATEMENT OF NON-PLAGIARISM PAGE

I hereby declare that all information in this document has been obtained and presented in accordance with academic rules and ethical conduct. I also declare that, as required by these rules and conduct, I have fully cited and referenced all material and results that are not original to this work.

Name, Last Name : Wisam ALI

Signature : 

Date : 27.04.2014

## ABSTRACT

### EFFICIENT PHASE ROTATION TECHNIQUES IN PAPR REDUCTION OF OFDM SYMBOLS

ALI, Wisam Hasan

M.Sc., Department of Electronics and Communication Engineering

Supervisor: Assoc. Prof. Dr. Orhan GAZI

April 2017, 57 Pages

Orthogonal frequency division multiplexing (OFDM) is an efficient digital multi-carrier wireless communication method that offers high-speed data rate, high spectral capability, and robustness to multipath fading. In spite of their enormous features, OFDM systems have high peak to average power ratios (PAPRs) which create serious problems for their use in practical communication systems. In this thesis we inspect multiple signaling PAPR reduction methods for OFDM communication systems. Multiple signaling PAPR reduction techniques include the partial transmit sequence (PTS), the tone injection (TI) and the tone reservation (TR) which has two implementation algorithms; the clipping based (TR-C) and the Kernel-based (TR-K) methods. We also tried a new PAPR reduction approach. The new method is based on the rotation of the information symbols before inverse fast Fourier transform (IFFT) processing. Via computer simulations, we compared the performances of classical multiple signaling and new optimum phase rotation tone PAPR reduction methods to each other.

**Keywords:** Orthogonal frequency division multiplexing, PAPR, CCDF, partial transmit sequence, tone injection, tone reservation, optimum phase rotation, clipping and kernel based tone reservation.

## ÖZ

### OFDM SEMBOLLERİNİN PAPR DEĞERLERİNİN DÜŞÜRÜLMESİNDE KULLANILAN VERİMLİ FAZ DÖNDERİM TEKNİKLERİ

ALI, Wisam Hasan

Yüksek Lisans, Elektronik ve Haberleşme Mühendisliği Anabilim Dalı

Tez Yöneticisi: Doç. Dr. Orhan Gazi

Nisan 2017, 57 Sayfa

Dikgen frekans bölmeli çoğullama yöntemi (DFBÇ) kablosuz haberleşmede kullanılan etkili haberleşme yöntemlerinden biridir. Bu haberleşme yöntemi yüksek iletişim hızlarına ulaşmada bant aralığını verimli kullanmada ve çoklu yol iletişimlerinde bizlere avantajlar sağlamaktadır. Diğer yandan DFBÇ yönteminin dezavantajları da mevcuttur. Doruk enerjisinin ortalama enerjiye bölümü (DOEB) sonucu DFBÇ sinyalleri için yüksek değerler almaktadır. Bu da iletişim sistemlerinde sorunlara sebep olmaktadır. Bu tez çalışmamızda yüksek DOEB değerlerinin düşürülmesi için literatürde önerilen çoklu sinyalleme tekniklerinin performanslarını bilgisayar benzetim yöntemleri ile elde edeceğiz. Çoklu sinyalleme tekniklerine örnek olarak kısmi gönderim dizinleri (KGD), ton enjekte etme (TE), ton rezervasyon (TR) verilebilir. Ton rezervasyon yöntemi iki değişik yöntemle yapılabilir. Bu yöntemler kırpma ve çekirdek tabanlı ton rezervasyon yöntemleri olarak verilebilir. Belirtilen tekniklere ek olarak yeni bir DOEB azaltma tekniği de denenecektir. Yeni teknik optimum faz dönüşümü tekniği olarak isimlendirilmekte ve zaman alanında kırım FFT algoritmasını göz önüne alarak veri sembollerinin döndürülmesini içermektedir. Bilgisayar benzetimleri ile önerilen ve var olan tekniklerin performansları birbirleri ile karşılaştırılmıştır.

**Anahtar Kelimeler:** Dikgen frekans bölmeli çoğullama, PAPR, CCDF, kısmi gönderim dizinleri, ton enjeksiyonu, ton rezervasyonu, en iyi faz döndürme, kesme ve çekirdek tabanlı tone rezervasyon.

## **ACKNOWLEDGEMENTS**

I would like to express my deepest gratitude to my supervisor Assoc. Prof. Dr. Orhan GAZI for his guidance and encouragement during my thesis study. I am very grateful for his leading role, advices and insight throughout the research.

I also wish to thank to all my family for their support and encouragement during my studies.

## TABLE OF CONTENTS

STATEMENT OF NON-PLAGIARISM PAGE .....	<b>Error! Bookmark not defined.</b>
ABSTRACT .....	iii
ÖZ .....	v
ACKNOWLEDGEMENTS .....	vi
TABLE OF CONTENTS .....	vii
LIST OF FIGURES .....	x
LIST OF ABBREVIATIONS .....	xii
1. INTRODUCTION .....	1
1.1 Orthogonal Frequency Division Multiplexing (OFDM) Systems.....	1
1.2 Advantages of OFDM System.....	2
1.3 Disadvantages of OFDM System .....	3
1.4 Applications of OFDM System .....	3
1.4.1 Wireline Applications of OFDM .....	3
1.4.2 The Wireless Applications of OFDM .....	3
1.5 Complementary Cumulative Distribution Function (CCDF).....	4
1.6 Effects of PAPRs on OFDM Systems .....	5
1.6.1 Bit Error Rate increase at the Receiver Part .....	5
1.6.2 Loss in Data Rate .....	5
1.6.3 Increasing Signal Power at the Transmitter Part .....	5
1.6.4 Computational Complexity .....	6
1.7 Aim of the Thesis .....	6
1.8 Structure of Thesis.....	6
2. BACKGROUND .....	8

2.1 Literature Review .....	8
2.2 Peak to Average Power Ratio in OFDM Communication Systems .....	8
2.3 Taxonomy of the PAPR Reduction Techniques.....	9
2.4.1 Signal Distortion Techniques.....	11
2.4.1.1 Clipping and Filtering Techniques.....	11
2.4.1.2 Companding Technique .....	12
2.4.1.3 Peak Cancellation Technique.....	13
2.4.2 Multiple Signaling and Probabilistic Techniques.....	14
2.4.2.1 Partial Transmit Sequence (PTS) Technique.....	15
2.4.2.2 Selective Mapping (SLM) Technique.....	15
2.4.2.3 Tone Reservation Technique.....	16
2.4.3 Coding Technique.....	17
2.4.3.1 Precoding Technique.....	17
3. PEAK TO AVERAGE POWER RATIO REDUCTION TECHNIQUES .....	19
3.1 Partial Transmit Sequence Technique.....	19
3.1.1 Mathematical Analysis of the PTS Technique .....	20
3.1.2 Partitioning Methods.....	22
3.2 Tone Injection Technique.....	24
3.2.1 Mathematical Analysis of the TI Technique.....	25
3.2.2 Details .....	26
3.3 Tone Reservation Technique.....	30
3.3.1 Clipping-based TR (TR-C).....	31
3.3.2 Kernel-based TR technique .....	33
3.4 Optimal Phase Rotation (OPR) Method.....	36
4. SIMULATION RESULTS .....	38
4.1 Apportionment of PAPR Using CCDF .....	38
4.2 PTS Approach for PAPR Reduction .....	40
4.3 The Simulation Result of Tone Injection Technique .....	43

4.4 The Simulation Result of the TR-C and the TR-K Method .....	45
4.5 Comparison of the PAPR Reduction Techniques .....	49
5. CONCLUSION .....	52
REFERENCES.....	53
CURRICULUM VITAE .....	57

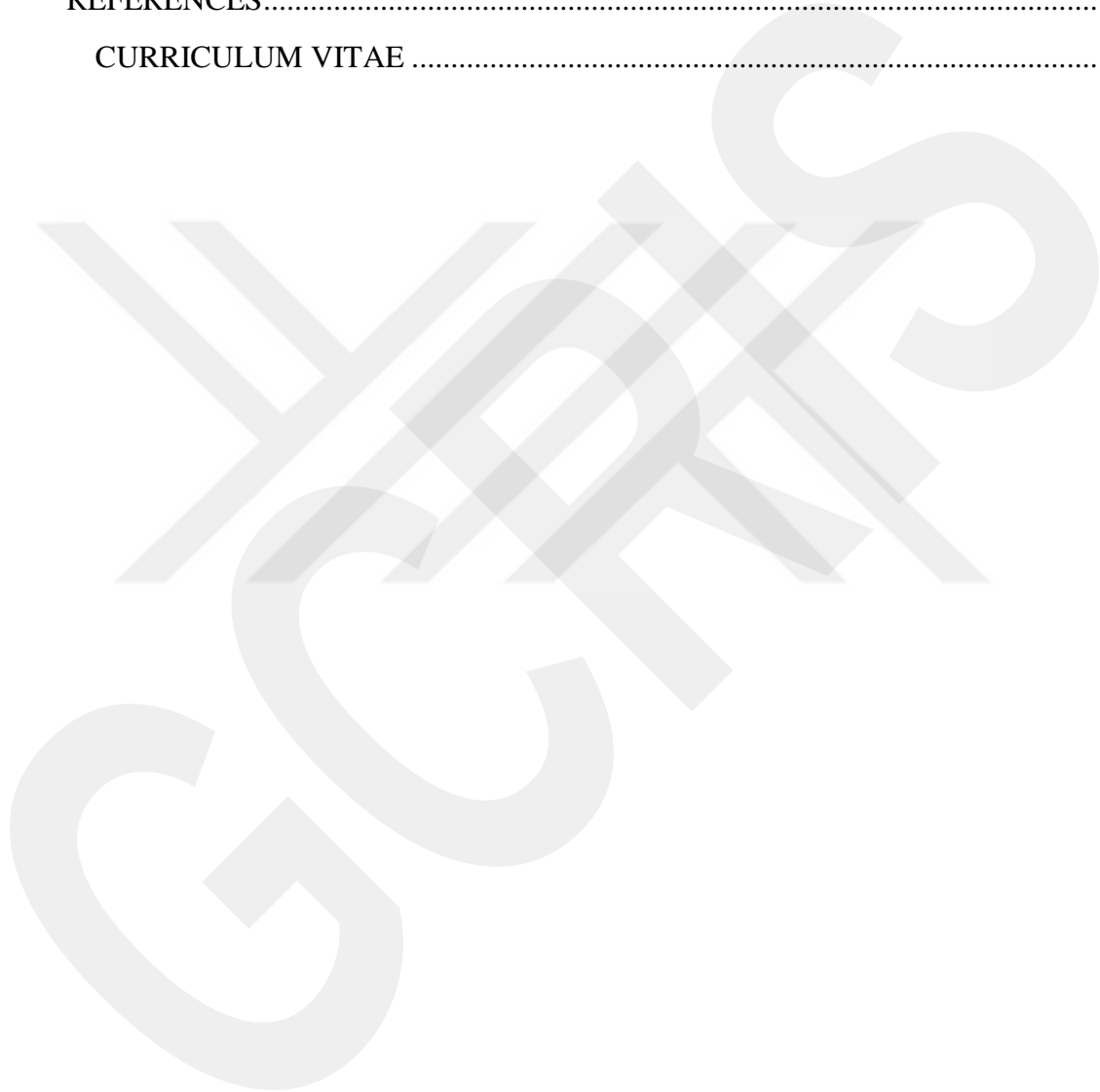

## LIST OF FIGURES

### FIGURES

<b>Figure 1</b> PAPR reduction techniques [17].....	10
<b>Figure 2</b> Amplitude clipping and filtering block diagram .....	11
<b>Figure 3</b> Stages of the peak cancellation technique [17].....	13
<b>Figure 4</b> Selective mapping technique .....	15
<b>Figure 5</b> Transmitter side of the pre-coded OFDM scheme .....	17
<b>Figure 6</b> Partial transmit sequence PAPR reduction technique.....	20
<b>Figure 7</b> Adjacent sub-block partitioning technique .....	22
<b>Figure 8</b> Interleaved sub-block partitioning technique. ....	23
<b>Figure 9</b> Pseudo-random sub-block partitioning scheme.....	24
<b>Figure 10</b> Block diagram of the TI technique. ....	25
<b>Figure 11</b> Performance mapping constellation points.....	27
<b>Figure 12</b> Tone injection technique with 4QAM constellation.....	29
<b>Figure 13</b> Tone reservation scheme at transmitter part. ....	30
<b>Figure 14</b> Classical amplitude clipping function [26].....	31
<b>Figure 15</b> Block diagram of the clipping based TR .....	33
<b>Figure 16</b> Block diagram of the TR kernel method .....	35
<b>Figure 17</b> Flowchart of the optimal phase rotation method .....	37
<b>Figure 18</b> CCDF curves of PAPRs for different number of subcarriers with BPSK modulation. ....	39
<b>Figure 19</b> CCDF curves of PAPRs for different number of subcarriers with 4-QAM modulation. ....	40
<b>Figure 20</b> Performance of PTS technique with different modulation schemes.....	41
<b>Figure 21</b> Performances of PTS and OPR with BPSK .....	42
<b>Figure 22</b> CCDF Performance Curves for PTS and OPR with 4-QAM .....	43

<b>Figure 23</b> Performances of TI and the PTS techniques.....	44
<b>Figure 24</b> PAPR Reduction Performances of TI, PTS and the OPR methods.....	45
<b>Figure 25</b> Performances of TR-C and the TR-K method with BPSK modulation....	46
<b>Figure 26</b> Performances of the TR-C, TR-K, and OPR methods.....	47
<b>Figure 27</b> Simulation results for the TR-C and TR-K methods with 4-QAM modulation scheme.....	48
<b>Figure 28</b> CCDF performances of TR-C, TR-K, and OPR methods. ....	49
<b>Figure 29</b> Simulation of the PAPR techniques, .....	50
<b>Figure 30</b> Simulation results of the PAPR techniques employing 4-QAM. ....	51

## LIST OF ABBREVIATIONS

OFDM	Orthogonal Frequency Division Multiplexing
BPSK	Binary Phase Shift Key
M-PSK	M-ary Phase Shift key
M-QAM	M-ary Quadrature Amplitude Modulation
DFT	Discrete Fourier Transform
IDFT	Inverse Discrete Fourier Transform
IFFT	Inverse Fast Fourier Transform
FDM	Frequency Division Multiplexing
ISI	Inter Symbol Interference
RF	Radio Frequency
PAPR	Peak to Average Power Ratio
BER	Bit Error Rate
CCDF	Complementary Cumulative Distribution Function
Q-PSK	Quadrature Phase Shift Keying
DPSK	Differential Phase Shift Keying
SLM	Selective Mapping
PA	Power Amplifier
TR	Tone Reservation
ADSL	Asymmetric Digital Subscriber Line
MOCA	Multimedia Over Coax Alliance

3GPP	3rd Generation Partnership Project
UMTS	Universal Mobile Telecommunications System
LTE	Long-Term Evolution
4G	4th Generations.
DAB	Digital Audio Broadcasting
DQPSK	Differential Quadrature Phase-Shift Keying
DVB	Digital Video Broadcasting
HPA	High Power Amplifier
PTS	Partial Transmit Sequence
TI	Tone Injection
TR-C	Tone Reservation Clipping Based
TR-K	Tone Reservation Kernel Based
CL	Clipping Level
CR	Clipping Ratio
OPR	Optimal Phase Rotation
IEEF	Institute of Electrical and Electronics Engineering
ADC	Analog to Digital Converter
DAC	Digital to Analog Converter
SQNR	Signal-to-Quantization-Noise
QAM	Quadrature Amplitude Modulation
OQAM	Offset Quadrature Amplitude Modulation
PRCs	Peak Reduction Carriers
OLSM	Open Loop Spatial Multiplexing

RS Reed-Solomon Code

RM Reed-Muller Code



## CHAPTER 1

### 1. INTRODUCTION

#### 1.1 Orthogonal Frequency Division Multiplexing (OFDM) Systems

The digital multi-carrier wireless communication systems offer high-speed data rate, high accuracy at minimum cost for many subscribers, robustness to multipath fading, immunity to impulse interferences and high spectral capability [16]. Moreover, the multi-carrier systems are able to be split the bandwidth into many sub-carriers. In multi-carrier wireless communication systems, every sub-carrier has a smaller part of the bandwidth compared to the single carrier transmission which uses the whole bandwidth. OFDM is a special case of the multi-carrier communication system. In OFDM communication systems the input bit stream is divided into sub-blocks and these sub-blocks are modulated via digital modulation techniques such as M-ary phase shift key (M-PSK), M-ary Quadrature Amplitude Modulation (M-QAM), Binary Phase Shift Key (BPSK) etc., and these sub-blocks are converted from serial to parallel and inverse Discrete Fourier Transform (IDFT) of each sub-block is calculated. In practical applications, inverse Fast Fourier Transform (IFFT) is generally employed instead of IDFT, because it is more cost effective to perform IFFT rather than IDFT [15]. The time domain OFDM symbols can be expressed as:

$$x_n = IFFT\{X_k\}$$

$$x_n = \frac{1}{\sqrt{N}} \sum_{k=0}^{N-1} X_k e^{j2\pi nk/N}, 0 \leq n \leq N - 1 \quad (1.1)$$

where,  $X_k$  is the transmitted symbol on the  $K^{th}$  subcarriers and  $N$  is the number of subcarriers. Although OFDM system has some features and benefits, it also has major disadvantages.

## 1.2 Advantages of OFDM System

- The OFDM system is most efficient when the sub-carriers overlap orthogonally, when compared to the Frequency Division Multiplexing (FDM) technique which has non-overlapping carriers, i.e., they are isolated and separated.
- The OFDM system is computationally efficient to utilize IFFT and Fast Fourier Transform (FFT) within the modulation and demodulation scheme.
- In order to decrease the equalization complexity of the OFDM system at the receiver, the wideband channel is split into flat fading sub channels.
- The OFDM system has the capability of parallel transmissions; it has a high resistance to frequency selective fading channels compared to the single carrier transmission systems, it achieves this by modifying a frequency selective fading channel into numerous flat fading channels.
- The OFDM system gives excellent protection against co-channel interference, where multipath propagation generates Inter-Symbol Interference (ISI). The utilization cyclic prefix between sequential OFDM symbols increases the immune of OFDM symbols to the ISI. Furthermore, OFDM signals are robust to the multipath propagation environment.

### **1.3 Disadvantages of OFDM System**

- The OFDM communication systems need Radio Frequency (RF) power amplifiers (PA) and they suffer from high peak to average power ratios (PAPR).
- The subcarriers participating through different transmitters lead the OFDM to be hard to coincide.

### **1.4 Applications of OFDM System**

There are two types OFDM applications; wireline application and wireless application.

#### **1.4.1 Wireline Applications of OFDM**

- Asymmetric Digital Subscriber Line (ADSL) offers internet access service over telephone network wires [29], and also has a data rate of it range from 256kbit/s to over 100 Mbit/s.
- Multimedia over Coax Alliance (MOCA) offers internet access service for data and HD video for home networking, it is utilized in practical systems, such as, digital video recorders, gaming and multi-room. The MOCA is divided into MOCA 1.1 and MOCA 2.0, it offers a data rate of 175 Mbit/s, 400Mbit/s-1Gbit/s, and its frequency range is 500 to 1650 MHz [30].

#### **1.4.2 The Wireless Applications of OFDM**

The OFDM is implemented in lots of applications like 3rd Generation Partnership Project (3GPP), Universal Mobile Telecommunications System (UMTS), Long-Term Evolution (LTE) and 4th Generation (4G). Moreover, referring to [17] we see that “the OFDM has been standardized as part of the IEEE 802.11a and IEEE 802.11g for high bit rate data transmission over wireless a local-area network (LAN)”.

- Digital Audio Broadcasting (DAB) was one of the first communication systems that employed the OFDM technique along with Differential Quadrature Phase-Shift Keying (DQPSK) modulation scheme. DAB has a multi-service transmitting, such as sound, image and text over a 1.5 MHz, the system also has 192 – 1596 carriers' frequency utilizing DQPSK [3].
- Digital Video Broadcasting (DVB) utilized the OFDM technique and QPSK, 16QAM, 64QAM modulation techniques and the DVB found applications in 2001 in Australia [4].

### 1.5 Complementary Cumulative Distribution Function (CCDF)

For measuring the efficiency of PAPR reduction techniques, the cumulative distribution function (CDF) is utilized. Usually, the complementary CDF (CCDF) is commonly utilized instead of the CDF. CCDF is used to measure the performance of PAPR reduction techniques [18] and [17]. Referring to [18] we can say that, using the central limit theorem, the real and imaginary parts of the time domain signal samples follow Gaussian distributions, each with a mean of zero and a variance of 0.5 for a multicarrier signal with a large number of subcarriers. The CDF for the amplitude of a signal can expressed as:

$$F(Z) = (1 - e^{-z}) \quad (1.2)$$

where,  $Z$  is the amplitude of complex samples, the complementary CDF of the PAPR is derived as:

$$\begin{aligned} P(\text{PAPR} > z) &= 1 - (F(Z))^N \\ &= 1 - (1 - e^{-z})^N \end{aligned} \quad (1.3)$$

in which,  $N$  is the number of sub-carriers.

## **1.6 Effects of PAPRs on OFDM Systems**

During the choice of PAPR technique for PAPR reduction some factors should be taken into account. These factors include, increment in Bit error rate (BER) at the receiver part, the loss in data rate, increment in signal power at transmitter part, and Computational Complexity [17]-[18]. We will explain briefly each item.

### **1.6.1 Bit Error Rate increase at the Receiver Part**

In some techniques, an increase in BER at the receiver may occur if the transmit signal power is fixed or equivalently may require larger transmit signal power to maintain the BER after the application of PAPR reduction technique.

### **1.6.2 Loss in Data Rate**

There are two types of PAPR reduction techniques, some of them need more bandwidth to send side information, and the other PAPR techniques do not need it. For instance, Partial Transmit Sequence (PTS), Selective Mapping (SLM) and interleaving methods utilize sending side information to the receiver side which results in reduction in data rate.

### **1.6.3 Increasing Signal Power at the Transmitter Part**

Some techniques such as PTS and SLM do not increase the average power signal at the transmit part, while the other techniques such as Tone Reservation (TR) and Tone Injection (TI) increases it. For instance, tones (peak reduction carriers) in Tone Reservation method employ more power to reduce PAPR and this is achieved by expanding the diagram.

#### **1.6.4 Computational Complexity**

One of the important factors is the computational complexity of the PAPR reduction technique. A PAPR technique which has too much complexity to reduce PAPR may be useless for practical applications.

#### **1.7 Aim of the Thesis**

We have been proposed a phase rotation method considering the rotation of the information symbols to reduce the PAPR of the OFDM system. And we compared the performance of the proposed method to those of the well-known techniques, the PTS technique, the TI technique and the TR technique. In TR method two different approaches are used are the clipping based (TR-C) method, and the kernel-based (TR-K) method.

#### **1.8 Structure of Thesis**

This thesis includes the study of PAPR reduction problem of OFDM system with several techniques, followed by the optimal phase rotation method for PAPR problem. The thesis is structured as follows:

- Chapter-2: It contains the background for PAPR reduction techniques and PAPR reduction methods are explained. Taxonomy of PAPR reduction techniques is provided. Some PAPR methods such as the clipping and filtering, the companding, the peak cancellation and the selective mapping techniques are explained briefly.

- Chapter-3: Some PAPR reduction techniques, including the PTS, the TI and the TR which it has two algorithms, the TR-C, and the TR-K, are explained in details.
- Chapter-4: This chapter presents the simulation results through utilizing of MATLAB platform. In this chapter our new hybrid phase rotation technique along with the classical PTS, TI, and the TR techniques are simulated and compared to each other.
- Conclusions are drawn in Chapter-5.

## CHAPTER 2

### 2. BACKGROUND

#### 2.1 Literature Review

To get the knowledge in a particular research field, the literature review is the main channel for researchers. Literature review offers the thorough study of the available article for a clear understanding of that particular field. Subsequently, this chapter offers a deep background and literature review on the PAPR of the OFDM system. The high PAPR of OFDM systems is the major matter of the OFDM signals which degrades the performance of OFDM communication systems. Besides, in this chapter we explain the different methods of PAPR reduction.

#### 2.2 Peak to Average Power Ratio in OFDM Communication Systems

The high PAPR is a drawback in OFDM communication systems. The PAPR found by dividing the maximum amplitude of the OFDM signal by the average value of the OFDM signal. The PAPR is defined as

$$PAPR = \frac{\text{max. power of the signal}}{\text{mean power of the signal}} \quad (2.1)$$

which can be mathematically written as:

$$PAPR = \frac{\max|x(n)|^2}{E[|x(n)|^2]} \quad (2.2)$$

where  $E\{\cdot\}$  is the expected value operator. The PAPR of the OFDM systems in dB is expressed as:

$$PAPR_{dB} = 10 \log_{10} PAPR. \quad (2.3)$$

The PAPR is also called the peak to average power ratio. CCDF is used to measure the performance of PAPR reduction techniques [5], [19] [21], [24], [27] and [28]. High PAPR can be reduced using various PAPR reduction techniques.

### **2.3 Taxonomy of the PAPR Reduction Techniques**

PAPR reduction techniques can be mainly divided into three categories: Signal distortion techniques, multiple signaling and probabilistic techniques and Coding techniques. Different types of PAPR techniques are illustrated in Figure 1.

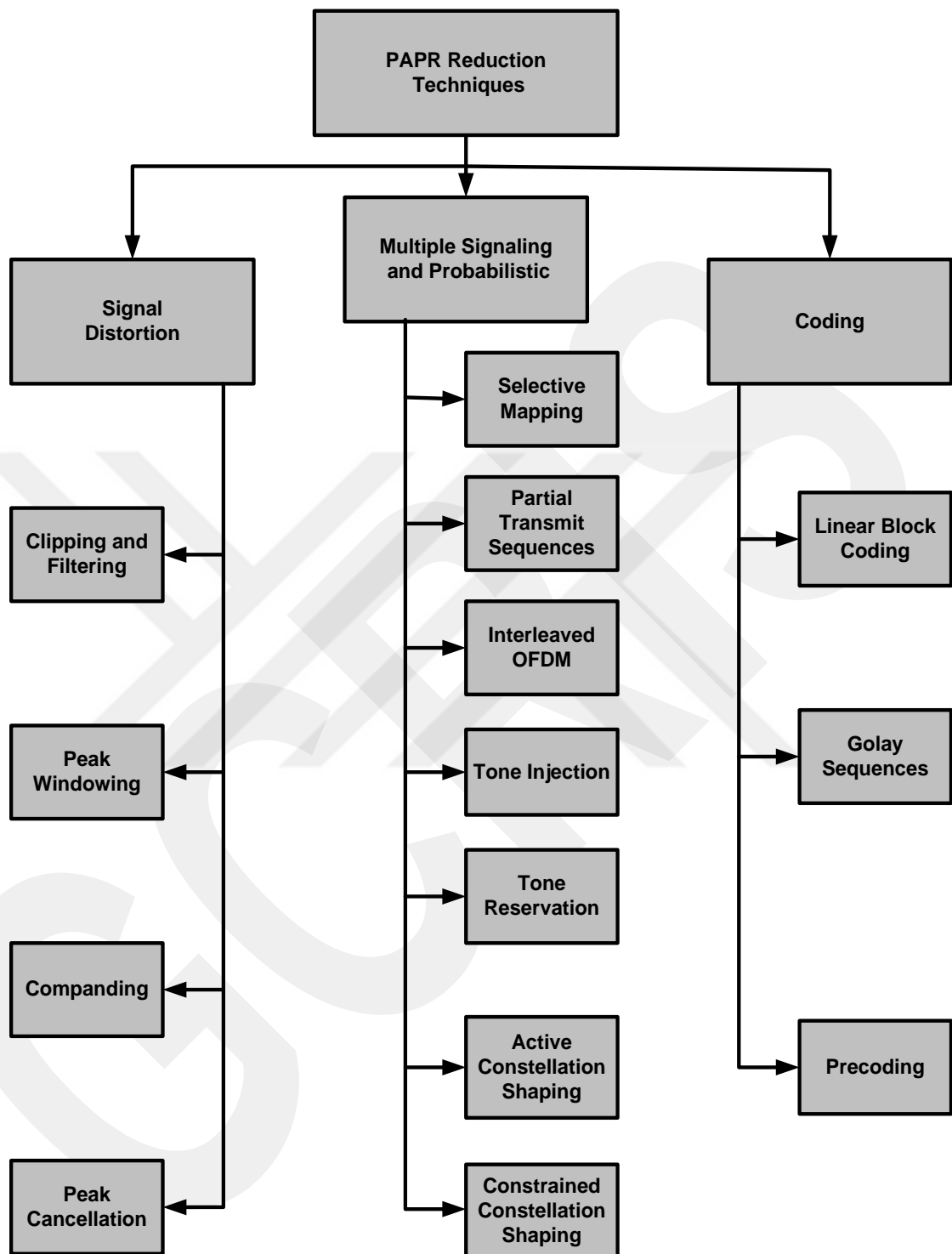

**Figure 1** PAPR reduction techniques [17]

## 2.4.1 Signal Distortion Techniques

In this class of PAPR reduction techniques, PAPR is reduced by distorting the OFDM signal non-linearly. Clipping and filtering, peak windowing, companding and peak cancellation are some examples of this class. These techniques are employed after the generation of OFDM signals.

### 2.4.1.1 Clipping and Filtering Techniques

Clipping and filtering are the simplistic techniques to reduce PAPR. Clipping method is performed before passing the signal through the power amplifier. The signal magnitudes exceeding the clipping level (CL) are set to equal to clipping level. The block diagram of amplitude clipping and filtering is illustrated in Figure 2.

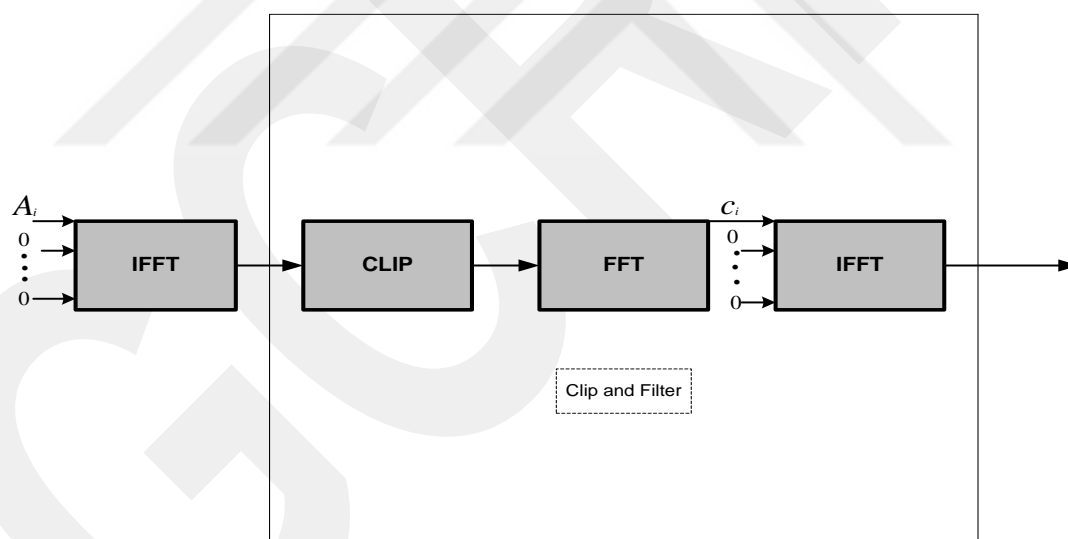

**Figure 2** Amplitude clipping and filtering block diagram

In [1], two types of amplitude clipping and filtering based upon PAPR reduction techniques are compared to each other. They have implemented the amplitude clipping

and filtering techniques over QPSK and QAM. It is observed that with the same number of the subscriber, there is no difference in the performance of QAM and QPSK, but in the case of increasing value of the Clipping Ratio (CR), QAM provides less PAPR than QPSK, i.e., for high CR, QAM is better than QPSK. As the CR increases BER decreases for QPSK.

W. Aziz, Ahmed, G. Abbas, S. Saleem and Q. Islam in [2] also employed clipping and filtering technique to reduce the amount of PAPR by clipping peak of the maximum power signal. They clip the peak signal to a maximum value after passing through pass band filter. Although passing through the filter increases the PAPR a bit, interference is a minimized at the receiver side.

#### **2.4.1.2 Companding Technique**

It is one of the best techniques to decrease audio signal data rate using unequal quantization level. It is a compressing technique and converts the analog signal to a digital one.

OFDM is one of the most efficient techniques of wireless communication which offers power efficiency, high spectral efficiency, and multipath delay tolerance. It is very sensitive to signal amplitudes. The OFDM is a multicarrier scheme in which we can add a number of their carrier, therefore, the average power of amplitude signal increases. There can be chances of distortion in operation of the system. There are a number of techniques for PAPR reduction, companding is one of the simple, effective and attractive technique for signal transformation. In [10], A.N. Jadhav, M. V. Kutwal, used companding to reduce the PAPR of OFDM signals. For companding operation they used the exponential function and airy function. They compared the performance of companding functions in terms of bit error rate and peak to average power ratio.

I.KoilPandi, N.Vignesh Ram in [11] explained companding technique which is non-linear in nature. The main aim of this technique is to compress the larger amplitude signals and simultaneously maintain average power constant. The proposed scheme is implemented for the different modulation schemes (BPSK, DPSK, QAM etc.). The BER performance is evaluated and compared by implementing the Nonlinear companding technique in the basic OFDM system. It helps to improve the performance of the system with low out-of-band distortion. In [11] it is shown that the nonlinear companding scheme could offer better system performance in terms of the PAPR reduction, and the BER performance.

### 2.4.1.3 Peak Cancellation Technique

It is a category of the PAPR reduction techniques for the OFDM communication systems. It can control out-of-band radiation and PAPR simultaneously in addition to interferences. A block diagram for the stages of the peak cancellation technique is illustrated in Figure 3.

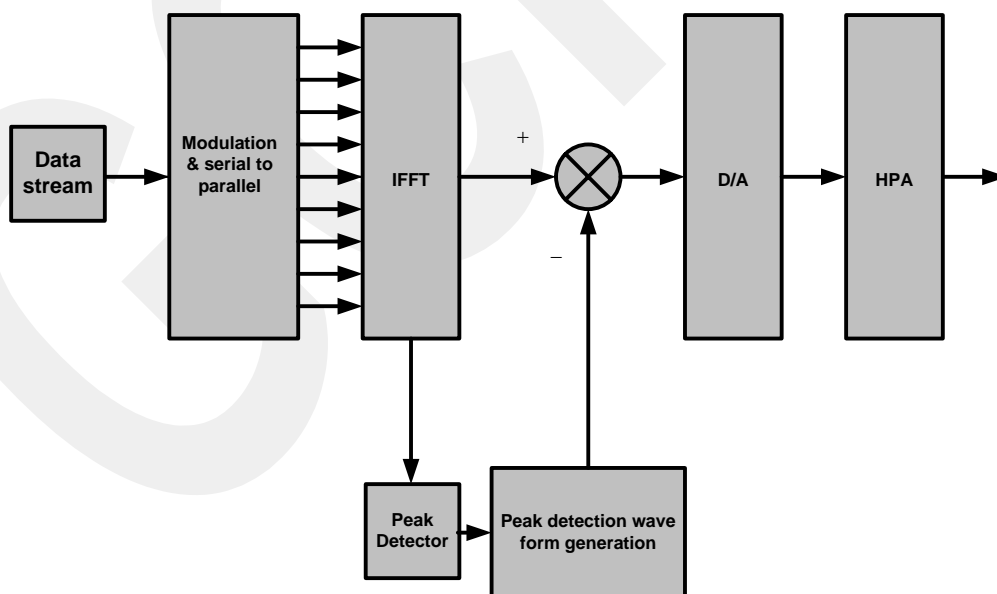

**Figure 3** Stages of the peak cancellation technique [17]

In [12], XIAO Yue, BAI WenLing, DAN LiLin, WU Gang & LI ShaoQian modeled the peak cancellation method and analyzed it to evaluate the performance of the OFDM communication systems. In addition, through theoretical analysis, a closed form of the BER performance is derived for OFDM for well-known modulation schemes such as QPSK and 16QAM.

In [13] Prabal Gupta et.al, proposed modified PTS scheme to eliminate the issue of the higher PAPR in OFDM communication systems. The standard array of the BCH code along with PTS algorithm is considered to get the better outcome of the proposed scheme. Experimental results show that with the help of proposed scheme PAPR is reduced more compared to classical PTS technique.

Chidurala Anjaiah and Hari Krishna Prasad P proposed a scheme by combining PTS and  $\mu$ -law companding techniques. It is found that the proposed method offers better PAPR reduction and better BER performance for SNR < 40 dBs. In their study, the proposed scheme provides better PAPR reduction when compared to PTS with four blocks and BER performance is the same with two blocks having least complexity with four blocks. The performance of their proposed scheme is better than mu-law companding, conventional PTS, SLM and combined versions of SLM, PTS.

#### **2.4.2 Multiple Signaling and Probabilistic Techniques**

Multiple signaling and probabilistic techniques are also called Signal scrambling techniques. In these methods the sequence that shows the smallest PAPR is chosen for transmission. We explain some studying methods belonging to Signal scrambling techniques such as the PTS, SLM, TI, and TR techniques.

### 2.4.2.1 Partial Transmit Sequence (PTS) Technique

In PTS technique, the data block  $X$  of length  $N$  is divided into  $V$  sub-blocks. The inverse discrete Fourier Transform  $IFFT$  of each one of these sub-blocks is calculated. And the calculated  $IFFT$  frames are weighted by phase factors  $b_v$  and then combined. The PTS technique is explained in details in Chapter three.

### 2.4.2.2 Selective Mapping (SLM) Technique

In selective mapping random phase rotation is performed for information symbols, and the set of phases that gives minimum PAPR are used for transmission. A block diagram of the Selective Mapping (SLM) technique is depicted in Figure 4.

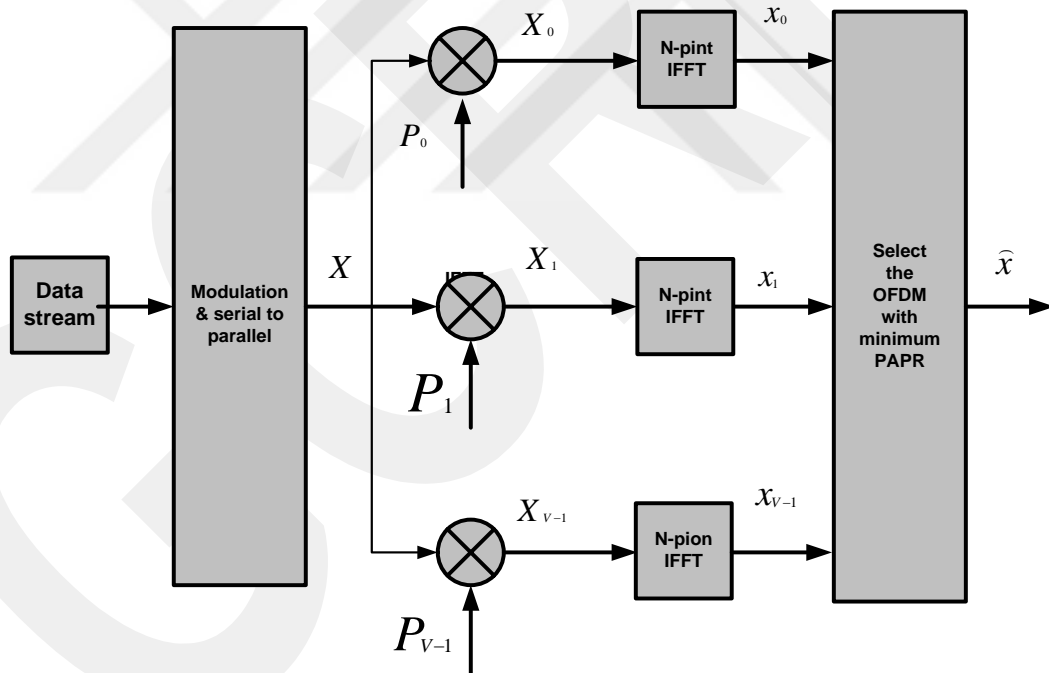

**Figure 4** Selective mapping technique

In [6], a comparison of signal scrambling PAPR reduction techniques with signal distortion techniques in OFDM signals is presented. It is mentioned in [6] that OFDM is a technique with high spectral efficiency, immunity to impulse and comes under the category of multi-carrier modulation technique. Frequency offset and PAPR are the main drawbacks of the OFDM technology. High PAPR causes saturation in subcarrier and distributes out of band energy. Therefore, there are many techniques like scrambling; clipping, SLM and much more have been discussed to reduce the PAPR in the network. These techniques are further broadly classified into various categories. In their study, they concluded that no technique is the optimal solution to reduce high PAPR. So, PAPR reduction technique should be chosen according to the requirement. Effects of the converter, amplifier, and noise must be considered to get good results.

Guobing Cheng, Huilei Li, Binhong Dong, Shaoqian Li, [7], defined that the OFDM is a promising technology in the wireless communication field. In their study, the selective mapping technique has been discussed for OFDM systems employing OQAM to reduce the PAPR. The main concern of this system is to find the best suitable method for OFDM signal to get the desired result by applying the basic principle of the OFDM using the SLM method. Open Loop Spatial Multiplexing (OLSM) technique is proposed in their study to reduce the complexity of the system having lower computational complexity.

#### **2.4.2.3 Tone Reservation Technique**

To reduce PAPR a subset of tones can be used for the transmission of pilot symbols. This is a convex problem and can be determined exactly. Data block and time domain signal are used together in the TR method. PAPR of data blocks are reduced with the help of reserved tones. We will inspect Tone reservation by two methods algorithm which TR-C method and TR-K method in details in Chapter three.

### 2.4.3 Coding Technique

Coding techniques are applied prior the production of the OFDM signal (before IFFT). The primary notion of coding schemes to decrease of PAPR by decreasing possibility of the equivalent phases signals. Appropriate code-words are chosen to reduce the PAPR. In coding method, a number of well-known codes can be used, such as block codes, cyclic codes, convolution codes, Reed-Solomon (RS) codes and Reed-Muller (RM) codes.

#### 2.4.3.1 Precoding Technique

Precoding technique's main goal is to obtain a lower PAPR signals and to minimize the obstruction created by multiple users. In precoding, the modulated data is multiplied by shaping matrix before the formation of OFDM symbols. The signals are modulated in baseband using digital modulation methods such as M-QAM, M-PSK etc. After that baseband modulated signal is transformed by a precoding matrix. Pulse coding, DCT methods can be used for pre-coding. Pre-coded OFDM system is depicted in Fig. 5.

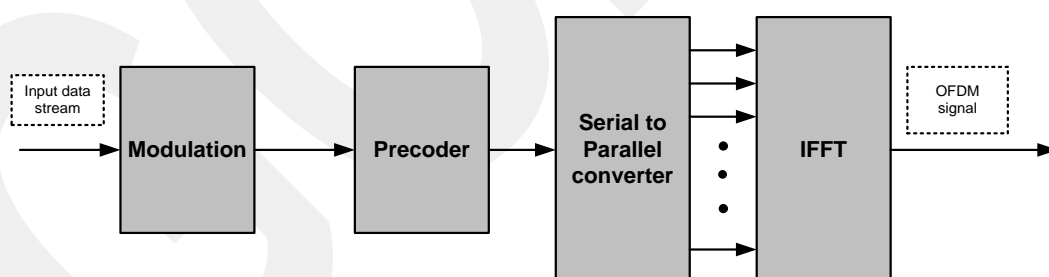

**Figure 5** Transmitter side of the pre-coded OFDM scheme

In [8], some superior techniques have been discussed to get better OFDM communication systems. Bit error rate with channel estimation errors and carrier frequency offset of the OFDM-MIMO system are examined in details. Residual

frequency intermarries interference and inner antenna interference are analyzed and SINR is derived. In addition, BER expressions employing equal gain combining and maximal ratio combining with precoding for OFDM-MIMO systems are derived.

Namitha.A.S and Sudheesh.P, [9], there are various technique and approaches which are available for the PAPR reduction. Precoding is the latest method which has low complexity as compared to the other power reduction techniques. It overcomes reduction and having no distortion in it. In [9], error coding technique combined with precoding is used for PAPR reduction. Clipping and filtering with bounded distortion is a simple method and provides a high PAPR reduction at the cost of signal distortion. In addition, in [9], the PAPR reduction is obtained by combining the precoding method and clipping technique with BD, i.e., this method takes the advantages of two PAPR reduction techniques.

## CHAPTER 3

### 3. PEAK TO AVERAGE POWER RATIO REDUCTION TECHNIQUES

The high PAPR of multicarrier OFDM signals is the main drawback of it. In this chapter, we describe and explain in details the proposed method (Optimal phase rotation) and the some of the important PAPR reduction techniques including, the PTS, TI and the TR techniques with two algorithms methods.

#### 3.1 Partial Transmit Sequence Technique

In PTS technique the information data block  $X$  of length  $N$  is divided into  $V$  non-overlapping sub-blocks.  $IFFT$  of each one of these sub-blocks is calculated and then via phase factors  $b_v, v = 1, \dots, V$  they are weighted. To get time domain OFDM signal with minimal PAPR all of the sub-blocks are optimally combined using the phase factors [17]. A block diagram of the PTS technique is showed in Figure 6. Referring to the PTS technique in [18], it can be said that the PAPR reduction relies on the number of sub-blocks  $V$  and the number of phase factors  $b_v$ . Sub-block partitioning aims to split the subcarriers into multiple sub-block. In Section 3.1.2, we explain the different types of sub-block partitioning. Since in PTS technique  $IFFT$  is performed each of the data blocks, complexity increases exponentially with the number of sub-blocks  $V$ .

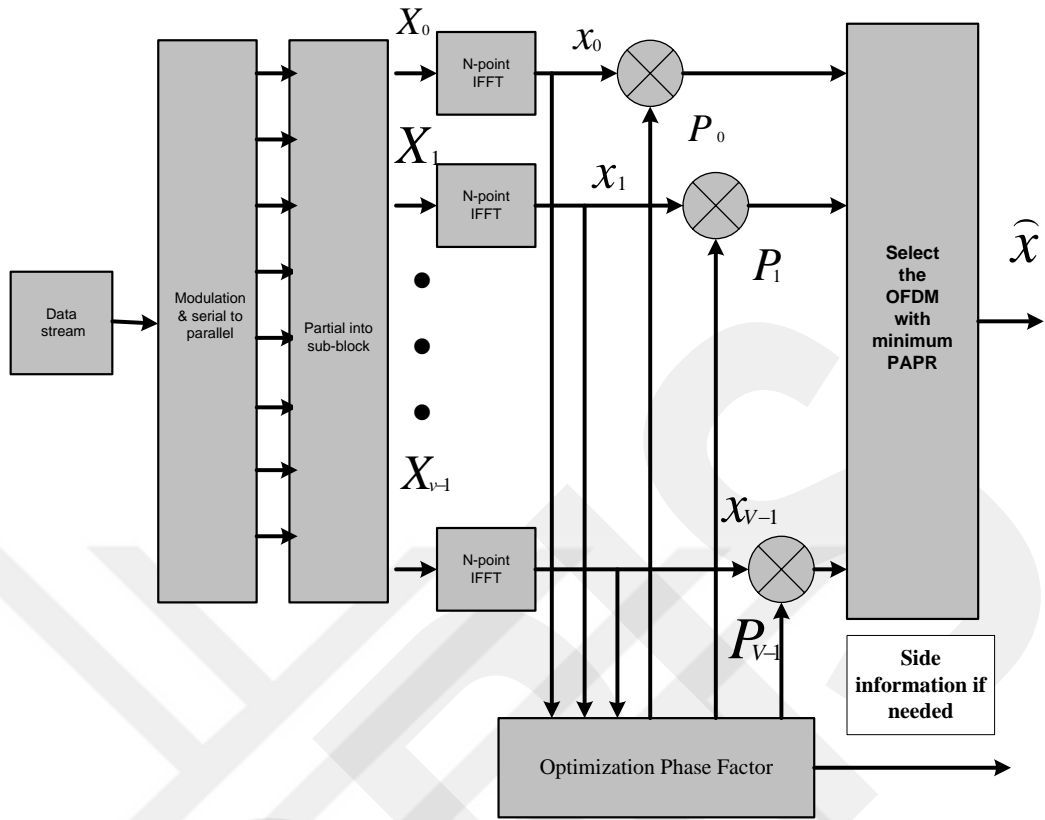

**Figure 6** Partial transmit sequence PAPR reduction technique

### 3.1.1 Mathematical Analysis of the PTS Technique

The data block  $X$  of length  $N$  after modulation is divided into sub-blocks then each *IFFT* of each sub-block is calculated. Then the phase factor  $b_v = e^{j\phi_v}$  where,  $v = 1, 2, \dots, V$  is multiplied by each partition sub-block.

Let's denote the data block by  $X$  and after its division into  $V$  pairwise disjoint sub-block let's show the sub-blocks by  $X_v, v = 0, 1, \dots, v - 1$ . The data block  $X$  can be written as:

$$X = \sum_{v=0}^{V-1} X_v \quad (3.1)$$

where,  $X_v = [X_v^0, X_v^1, X_v^2, \dots \dots \dots, X_v^{n-1}]^T$ , i.e., each sub-block has the same size. The phase factor defined as:

$$b_v = e^{j\phi_v}, \phi \in \{0, 2\pi\} \quad (3.2)$$

By taking the *IFFT* of (3.1) we obtain

$$x = IFFT \left\{ \sum_{v=1}^V X_v b_v \right\} \quad (3.3)$$

$$x = \sum_{v=1}^V b_v \cdot IFFT\{X_v\} \quad (3.4)$$

$$x = \sum_{v=1}^V b_v x_v. \quad (3.5)$$

In (3.1)  $X_v$  is the PTS. The phase factor should be selected in such that the PAPR can be minimized, this procedure is illustrated in:

$$\{\tilde{b}_1, \dots, \tilde{b}_v\} = \arg \min \left( \max_{n=0,1,\dots,N-1} \left| \sum_{v=1}^V b_v x_v[n] \right| \right) \quad (3.6)$$

where,  $n = 0, 1, 2, \dots, N - 1$ . After determining the optimum phase values using (3.6) the corresponding time domain signal with the lowest PAPR is generated using

$$\tilde{x} = \sum_{v=1}^V \tilde{b}_v x_v. \quad (3.7)$$

### 3.1.2 Partitioning Methods

There are three types of partitioned schemes, adjacent partition, pseudo-random partition and interleaved partition. The following example illustrated the partitioning into four sub-blocks, i.e.,  $V = 4$  of the OFDM partial transmit sequence technique with eight sub-carriers, i.e.,  $N = 8$ . The adjacent sub-block partitioning of the partition method is illustrated in Fig. 7.

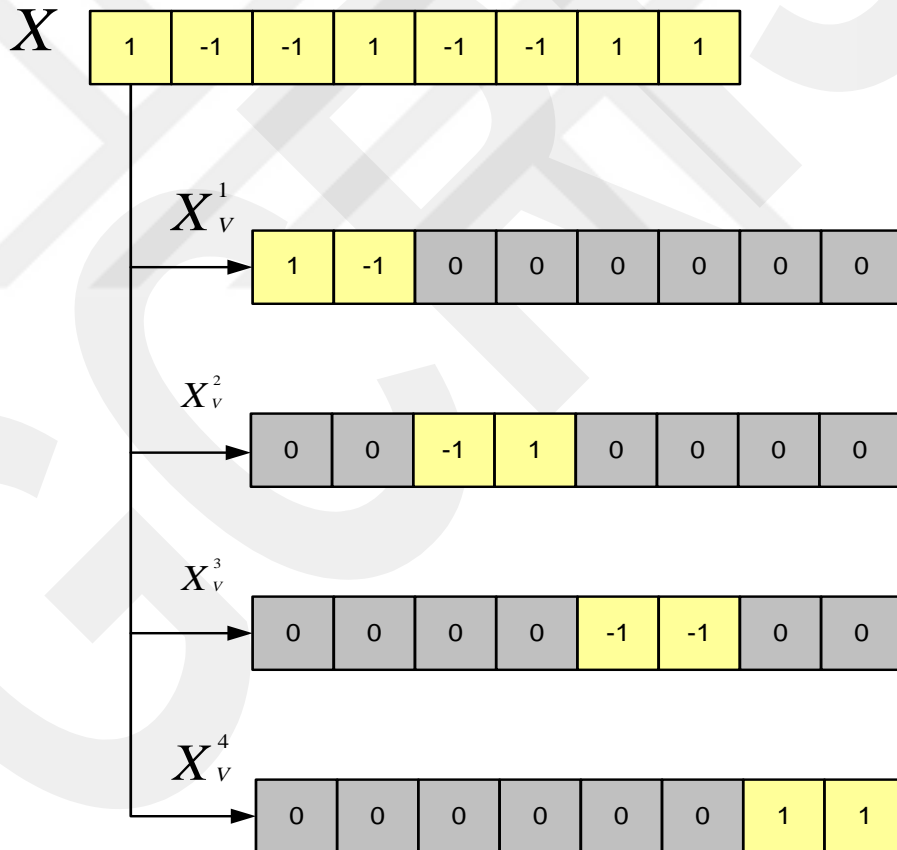

**Figure 7** Adjacent sub-block partitioning technique

The interleaved sub-block partitioning method is depicted in Fig. 8.

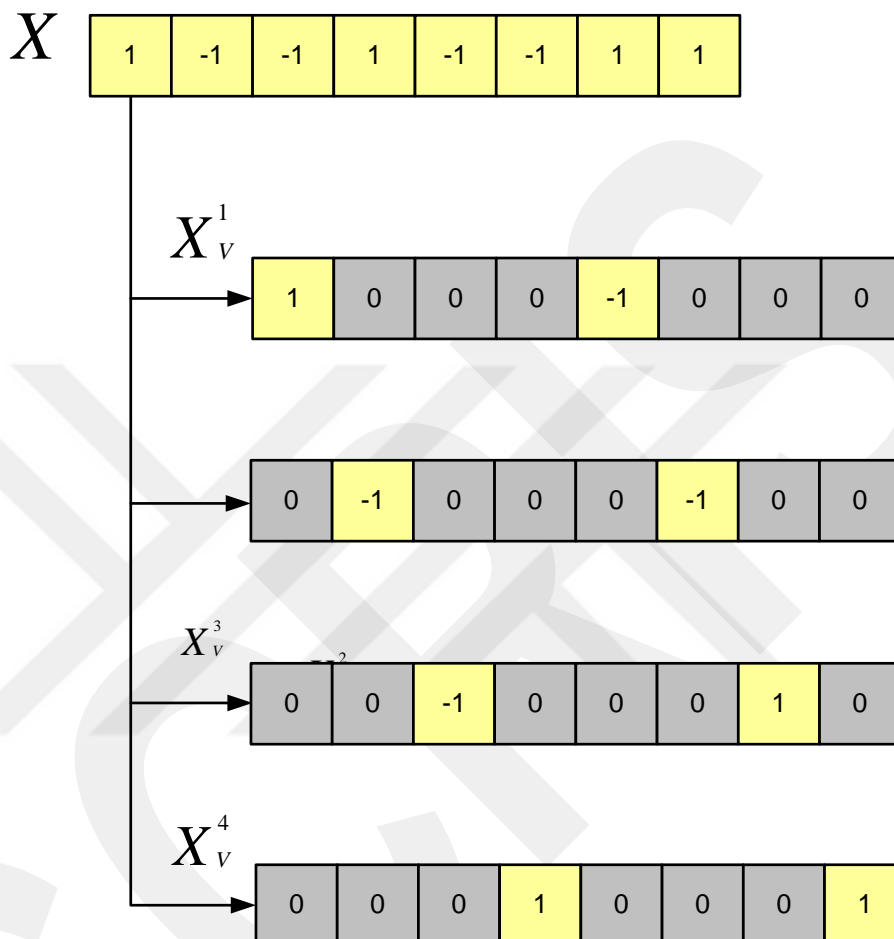

**Figure 8** Interleaved sub-block partitioning technique.

The Pseudo-random sub-block partitioning method is showed in Fig. 9.

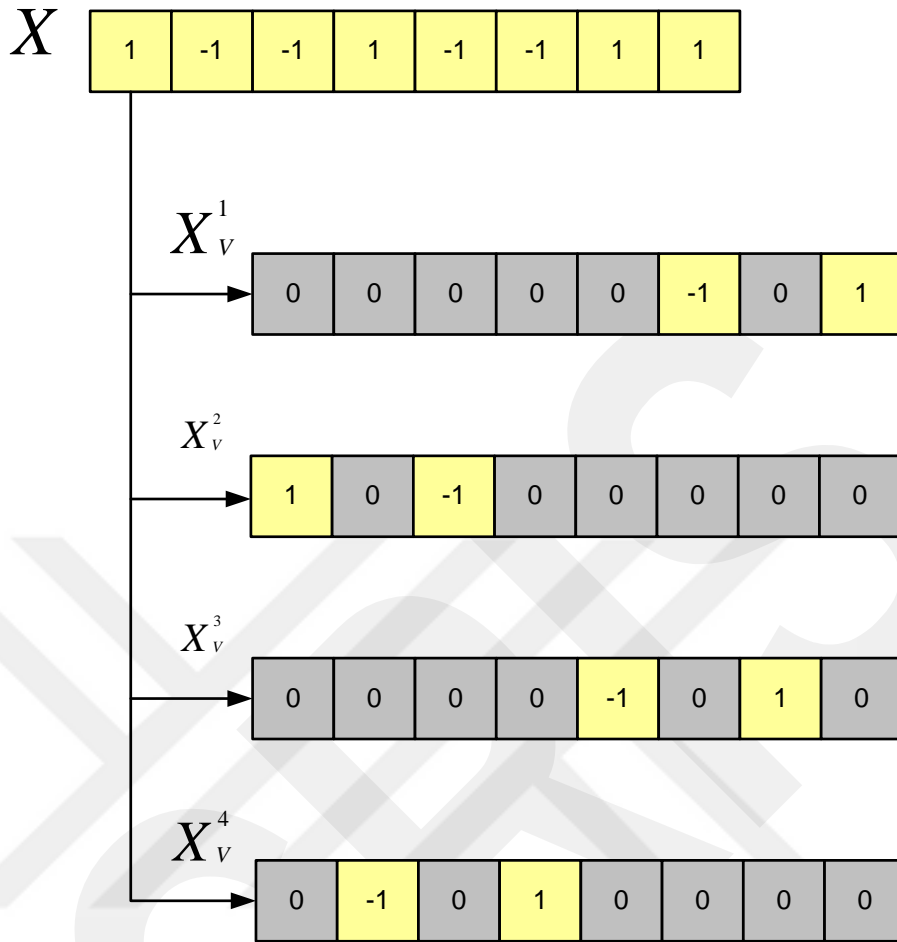

**Figure 9** Pseudo-random sub-block partitioning scheme.

### 3.2 Tone Injection Technique

The concept tone injection is based on adding constants  $C$  to some locations of the OFDM symbols. The constants  $C$  should be chosen such that PAPR is decreased and BER is not increased [23]. The constellation magnitude increases via the constants  $C$  so that the whole points in the original complex plane constellation can be mapped into the other various points within the expanded constellation. A block diagram of the TI technique at transmitter part is showed in Fig. 10.

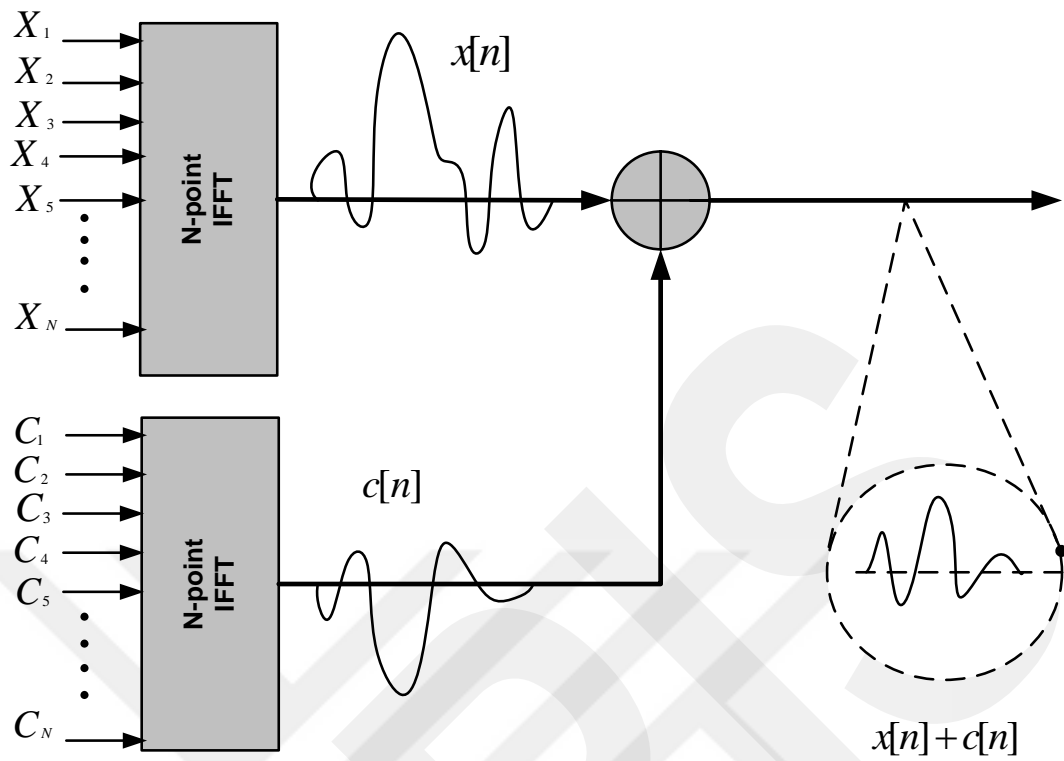

**Figure 10** Block diagram of the TI technique.

### 3.2.1 Mathematical Analysis of the TI Technique

Let  $\tilde{x}[n]$  be the time domain OFDM signal consisting of data signal and constant signal [20] as in

$$\tilde{x}[n] = x[n] + c[n] \quad (3.8)$$

which can be written in terms of *IFFT* coefficients as

$$\tilde{x}[n] = \frac{1}{\sqrt{N}} \sum_{k=0}^{N-1} (X[k] + C[k]) e^{j\frac{2\pi}{N}kn} \quad (4.9)$$

In (3.8) and (3.9),  $\{c[n]\}_{n=0}^{N-1}$  &  $\{C[K]\}_{K=0}^{N-1}$  indicate the time domain and the frequency domain representation of the constant signal.  $C[k]$  in (3.9) can be written as

$$C[k] = p[k].D + j q[k].D \quad (3.10)$$

where  $p[k]$  and  $q[k]$  are the integer values which can be chosen from the set  $[-1 0 1]$ . The integer values are selected to minimize the PAPR, while  $D$  is a constant number. Using the *modulo - D* operation  $C[k]$  can be removed at receiver [20]. The equation (3.9) after adding the  $C[k]$  becomes as

$$\tilde{x}[n] = \frac{1}{\sqrt{N}} \sum_{k=0}^{N-1} (X[k] + p[k].D + j q[k].D) e^{j\frac{2\pi}{N}kn}. \quad (3.11)$$

### 3.2.2 Details

The constants  $C$  are added to the tones bearing data, so these constants  $C$  modifies signal points of these tones to the new signal points with signal constellation magnitude larger than original signal constellation magnitude. On the other hand, in TR, the constant terms  $C$  representing the peak reduction carriers (PRCs) are added to the unused [23].

In the TI method we used the 4QAM modulation. The 4QAM constellation points are mapped to a expanded  $9 \times 4$ QAM constellation. One of them is used by the transmitter to bear the information data. These extra degrees of freedom can be utilized to reduce PAPR. The performance of constellation mapping after adding

$p[K].D + j q[K] D$  to original constellation is illustrated in Fig. 11 where the red and the blue triangle symbols are bearing the same information data symbols and the tone injection technique chooses appropriate constellation that reduces the PAPR.

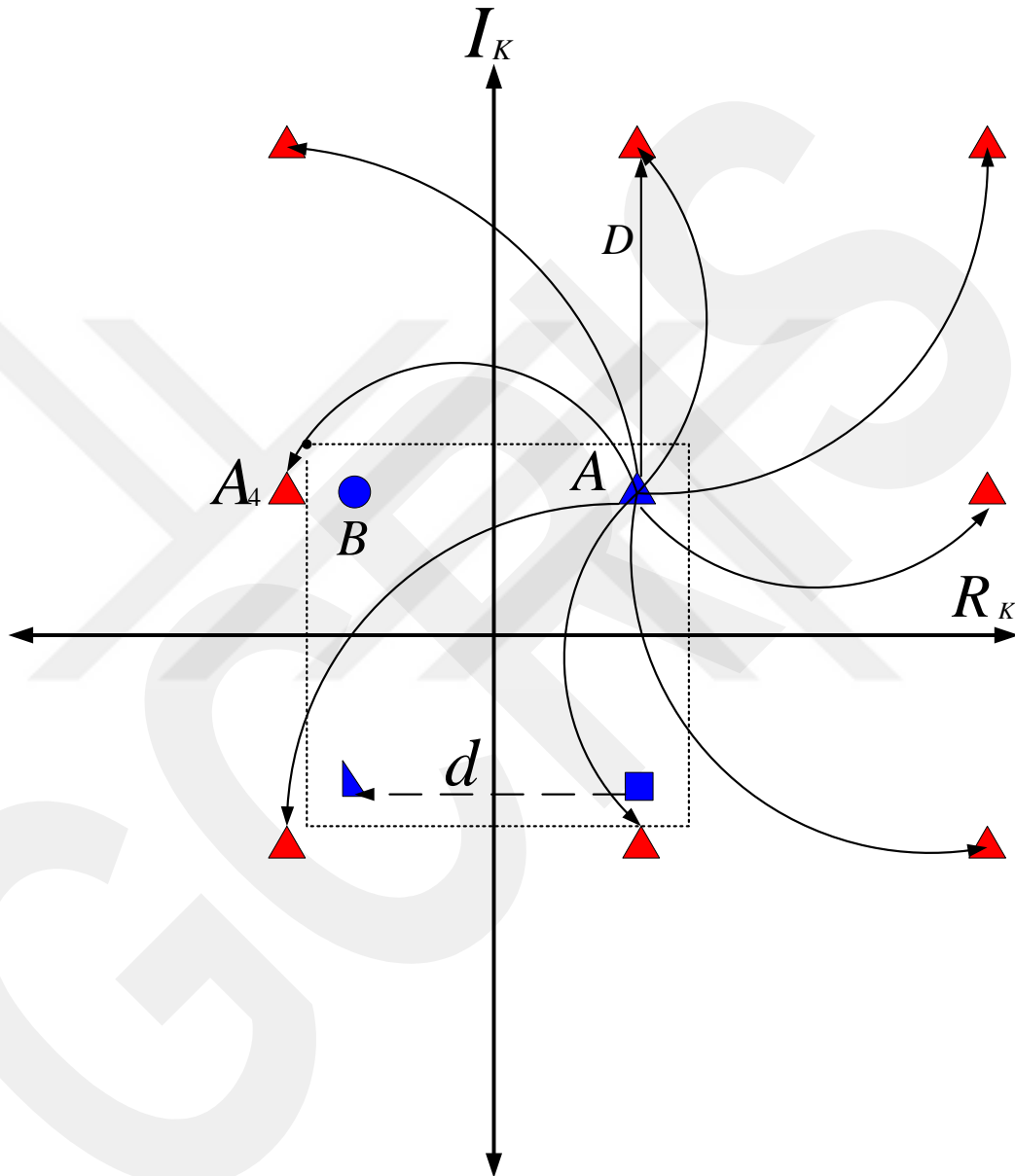

**Figure 11** Performance mapping constellation points

According to [20], using a *modulo* –  $D$  operation  $C[k]$  can be easily eliminated at the receiver using the real and imaginary parts of the output of the frequency equalizer (FEQ). If we do not want to raise the complexity at the receiver, we must choose the value of  $D$  carefully. We should note that  $D$  is a positive real number known at the transmitter and the receiver part [22],

- If we choose  $D = d M/2$ ,

where  $M$  indicates the number of levels per dimension and  $d$  is the minimum distance between constellation points,  $A_4$  will be nested with  $B$  and the receiver will decode  $A$  wrongly.

- If we choose  $D = (d M) / 2 + d/2$ ,

$A_4$  will not be a nested point in transmitter constellation, but the minimum distance between possible transmit point will be only  $d/2$  instead of the original  $d$ .

- If we choose  $D \geq d M$ ,

the probability of decoding  $\tilde{A}$  wrongly for an encoded system is almost the same as the probability of decoding  $A$  wrongly.

- If we choose  $D = d M$ ,

the constellation turns into a grid, and the original  $4QAM$  constellation is mapped to a larger constellation, where we can use one of all values that carry the similar information data.

In this technique, we used 4QAM as a modulation. The real part of  $X[k]$ ,  $R_k$  and the imaginary part,  $I_k$  can take these values from the set  $\{\pm d/2, \pm 3d/2, \dots, \pm (\sqrt{M} - 1)d/2\}$ .

Let's assume that  $X[k] = A$  and  $A = d/2 + j3d/2$ , modifying the real and/or imaginary part of  $A$  could reduce the peak to average power ratio of the OFDM signal [22]. The original symbol shown in Fig. 12 on constellation  $A$  is mapped to one of  $A_i$ 's,  $\{i = 1, 2 \dots, 8\}$  from which appropriate values of  $p[k]$  and  $q[k]$  can be obtained. The TI scheme for 4QAM constellation is illustrated in Figure 12. One of these points  $A_1$  to  $A_8$  is taken for transmission to reduce the PAPR of the OFDM signal.

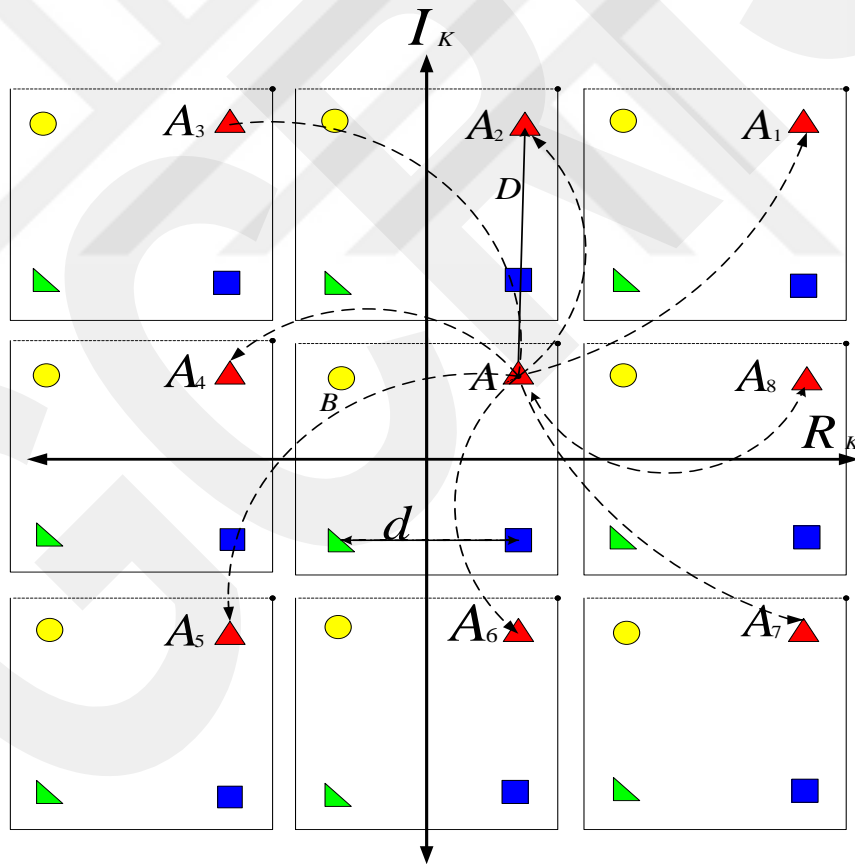

**Figure 12** Tone injection technique with 4QAM constellation

### 3.3 Tone Reservation Technique

The TR method is an efficient technique utilized to reduce the PAPR value of multicarrier OFDM signals. This technique is based on a principle idea; a small data set of tones (subcarriers) is kept in the original OFDM signal which helps to reduce its peak. These tones do not carry data, and they are only used to reduce the peaks in the original time domain signal [26]. The block diagram of the TR method is shown in Fig. 13. We will explain in details two methods of TR technique, the TR-C method and TR-K method.

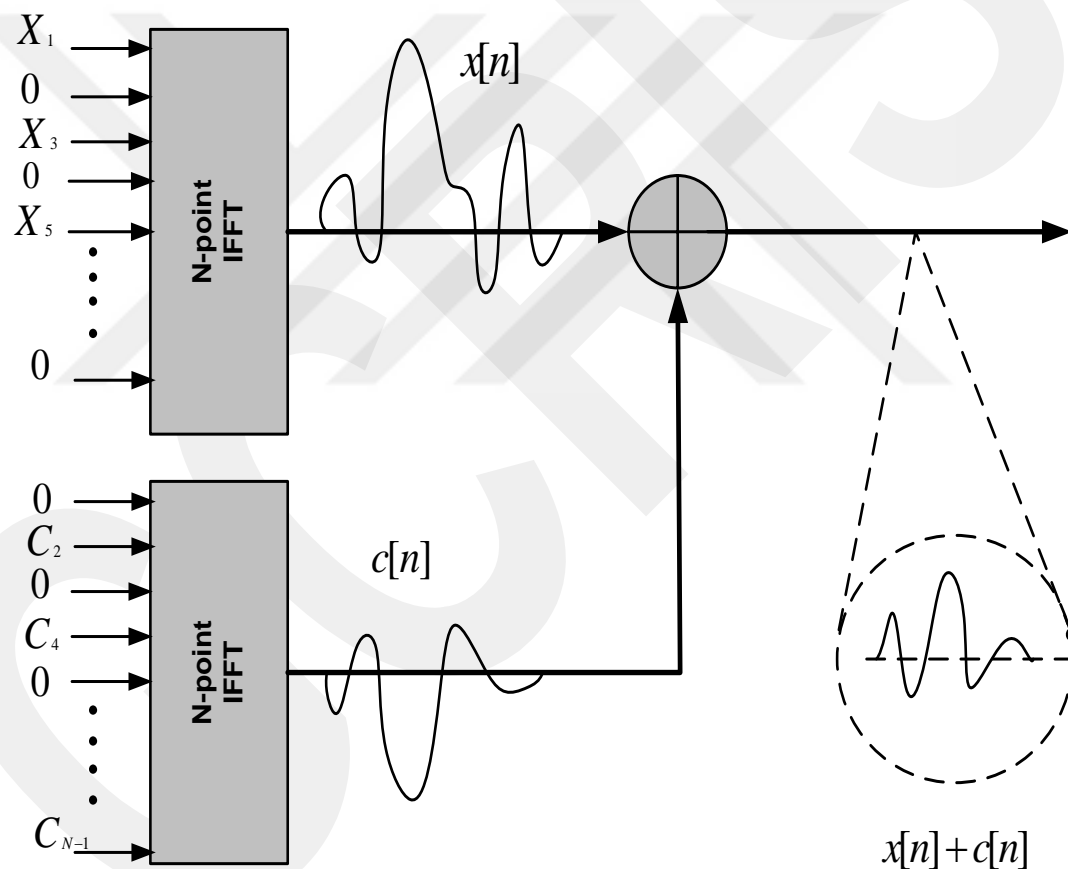

**Figure 13** Tone reservation scheme at transmitter part.

### 3.3.1 Clipping-based TR (TR-C)

In this scheme, we first implement a clipping on the  $x_n$  signal to calculate clipped signal  $y_n$ .  $x_n$  represents the OFDM signal vector and utilizing a classical amplitude clipping  $y_n$  is obtained [25]. The calculation of clipped signal  $y_n$  is illustrated in Fig. 14.

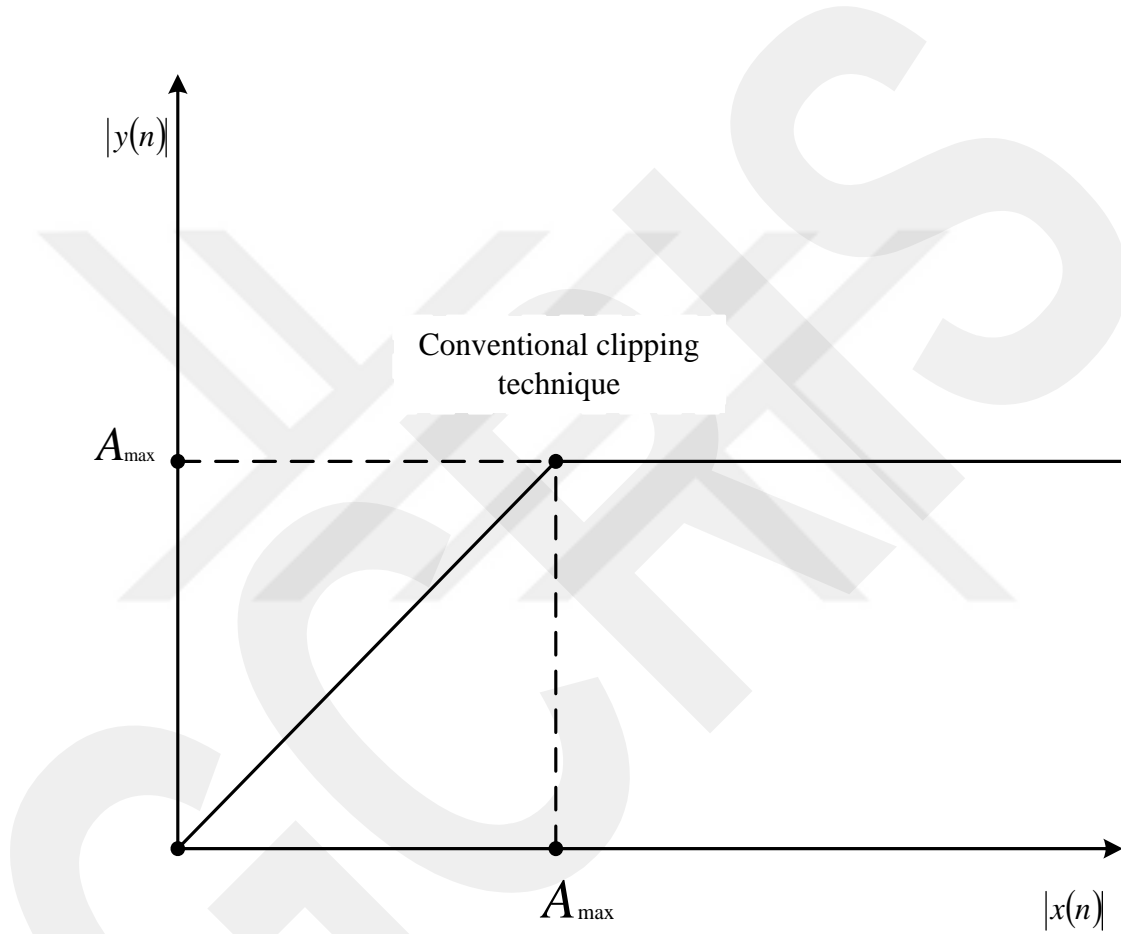

**Figure 14** Classical amplitude clipping function [26]

After clipping operation, the clipped signal  $y_n$  is subtracted from the original OFDM signal vector  $x_n$  to obtain the correction signal  $c_n$ . These operations are explained in (3.12) and (3.13) as

$$y_n = \begin{cases} x_n, & |x_n| \leq A_{max} \\ A_{max} e^{j\phi(x_n)}, & |x_n| \geq A_{max} \end{cases}, \quad (3.12)$$

$$c_n^i = x_n^i - y_n^i, \quad (3.13)$$

where  $x_n$  is the original OFDM signal,  $y_n$  is the clipped signal,  $A_{max}$  is the clipping magnitude level and  $c_n^i$  is so-called the correction signal. When correction signal is obtained we take its FFT, i.e.,

$$C_k = FFT(c_n^i). \quad (3.14)$$

For the sequence obtained in (3.14) we null some of the positions, i.e., we save just the values on the pre-determined positions, while other values could be set to zero [25]

$$\tilde{C}_k = \begin{cases} C_k & k \in PRC \\ 0, & k \notin PRC. \end{cases} \quad (3.15)$$

Applying  $IFFT$   $\tilde{C}_k$  we obtain the time-domain signal  $\tilde{c}_n$  which is added to the original OFDM signal  $x_n$ , to create the new transmitted signal  $x_n^i$  as:

$$x_n^i = x_n + \mu \tilde{c}_n \quad (3.16)$$

where  $\mu$  indicates the value of the weight factor. A block diagram of the TR-C scheme is shown in Fig. 15.

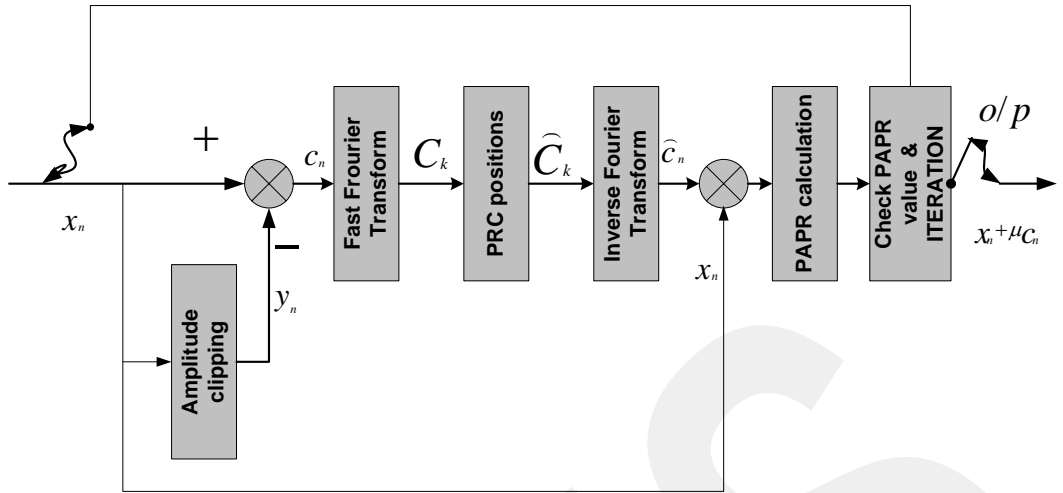

**Figure 15** Block diagram of the clipping based TR

### 3.3.2 Kernel-based TR technique

The concept TR-K method technique is based on the idea that the high PAPR values can be decreased if the peaks values in the OFDM signal vector are decreased. There are three main steps of the TR-K method [25].

*First step:* A kernel vector denoted by  $p_n$  is generated. The kernel vector should be a discrete impulse-like function. The kernel vector is generated using

$$p_n = \frac{\sqrt{N_{FFT}}}{N_{PRC}} IFFT(p_k), \quad (3.17)$$

where  $N_{FFT}$  and  $N_{PRC}$  denote the  $FFT$  size and the number of the peak reduction carriers sequentially. The  $p_k$  is a vector with size of  $N_{FFT}$ . The values of  $p_k$  are equal to one at the PRCs positions i.e.,  $p_k = 1, k \in k_{PRCS}$  and the other values equal zero, i.e.,  $p_k = 0, k \notin k_{PRCS}$ .

*Second step:* The OFDM signal vector  $x_n$  is passed through the peak-cancellation block to calculate the maximum amplitude  $A^i$  and its index  $m^i$  for every iteration. This operation is mathematically expressed in equations (3.18) and (3.19) as

$$A^i = \max_n |x_n| \quad (3.18)$$

$$m^i = \arg \max_n |x_n|. \quad (3.19)$$

*Third step:* The reference kernel vector  $p_n$  is circularly shifted to the  $m^i$  position, where the maximum peak of the reference kernel vector  $p_n$  could be in similar position  $m^i$  [25]. The following example explains these procedures. Let's assume that the OFDM vector  $x_n$  is given as

$$x_n = [2 \ 4 \ 6 \ 8 \ 10 \ 1 \ 3 \ 5 \ 7 \ 9]$$

The maximum value '10' in OFDM signal vector has the position '5'. Let's choose the reference kernel vector  $p_n$  as

$$p_n = [2 \ 4 \ 3 \ 1 \ 1 \ 3 \ 4 \ 5 \ 4 \ 2]$$

The maximum value of the reference kernel vector  $p_n$  vector is '5' and it appears at position '8', and the two vectors have the same length. We modify the kernel vector  $p_n$  depending on the OFDM signal vector  $x_n$  and we do circular shift the kernel vector  $p_n$  and put the maximum value of it to the same position where  $x_n$  has its maximum value. Then we obtain,

$$p_n = [1 \ 1 \ 3 \ 4 \ 5 \ 4 \ 2 \ 2 \ 4 \ 3].$$

In the next step, we aim to reduce the peak value. For this purpose, the scaling factor is calculated as in (3.20) and then rotated kernel vector is scaled by the scaling factor and subtracted from the original signal. This operation is mathematically expressed in (3.21).

$$\alpha^i = \frac{x_n^i(m^i)}{A_{max}^i} (A_{max}^i - A_{clip}), \quad (3.20)$$

$$x_n^i = x_n - \alpha^i p_n(m^i). \quad (3.21)$$

In (3.20),  $A_{clip} p_n(m^i)$  indicates the clipping amplitude and the circularly shifted kernel vector sequentially. The iteration is stopped if the determined PAPR value falls below a specific level to [25]. The TR-K iteration should terminate, if a repetition number is surpassed. The two parameters, the repetition number and the PAPR threshold value must be determined beforehand before the starting of the algorithm. A block diagram of the TR-K scheme is shown in Fig. 16.

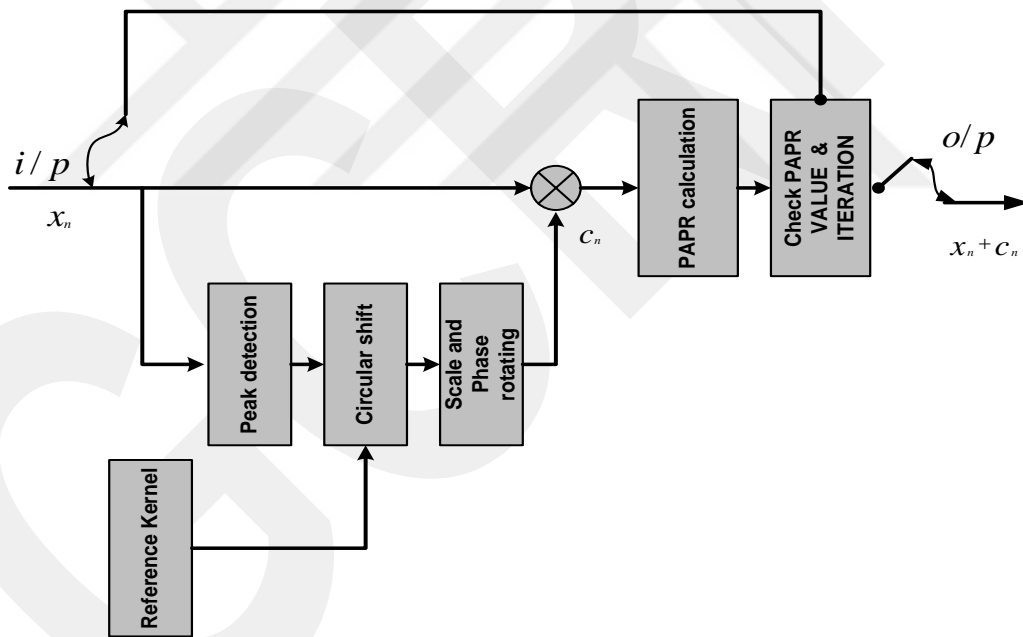

**Figure 16** Block diagram of the TR kernel method

### 3.4 Optimal Phase Rotation (OPR) Method

When the decimation in time FFT algorithm is inspected in details, it is seen that the information symbols according to their odd and even index values are paired, summed, subtracted and results are phase rotated and finally all rotated results are summed. This procedure is repeated for odd indexed information symbols. Motivating from these results, we consider choosing subgroups of both even and odd indexed elements and do some extra phase rotation on these pairs so that lower PAPR is achieved. Additional phase rotation values for the information symbols pairs appearing in the selected subgroups are selected as  $0, \pi$ .

The first element of the phase vector is used for the rotation of the even indexed data pairs, while the second element is used for the rotation of odd indexed data pairs. After each rotation, *IFFT* and PAPR are calculated and phase value that results in lower PAPR is recorded. This method can be considered for more than two phase candidates. In this case a number of phase candidates are tried for even and odd indexed chosen pairs and in a similar manner those phase values giving the minimum PAPR are determined to be employed for phase rotation operation during the transmission.

The example is illustrated eight sub-carriers  $N = 8$  with the phase factor has values  $\phi_1 = 0$ , and  $\phi_2 = \pi$

Let's  $S = [S_0 S_1 S_2 S_3 S_4 S_5 S_6 S_7]$ ,

*odd indexed* =  $[(S_0 S_2), (S_4 S_6)]$ , and *even indexed* =  $[(S_1 S_3), (S_5 S_7)]$ .

Then we selected subgroups from odd and even indexed as:

*odd subgroup indexed* =  $[S_0 S_2]$ , and *even subgroup indexed* =  $[S_5 S_7]$ .

The modify the information signal after adding phase vectors is become:

$$S_1 = [S_0 e^{j\phi_1} \ S_1 \ S_2 e^{j\phi_1} \ S_3 \ S_4 \ S_5 e^{j\phi_2} \ S_6 \ S_7 e^{j\phi_2}],$$

And then we take *IFFT* for the signal  $s = IFFT(S)$ , the phase vector is reached to minimum *PAPR*. flowchart of the optimal phase rotation method is shown in Fig. 17.

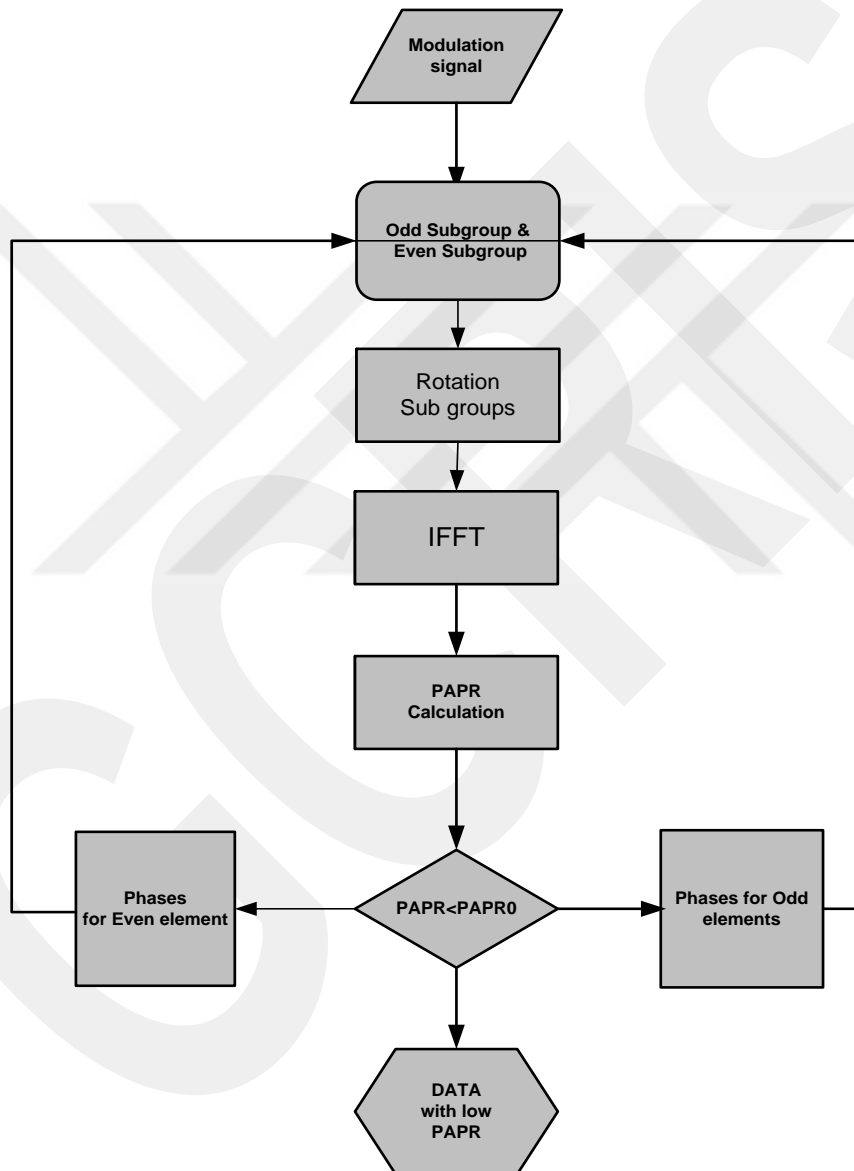

**Figure 17** Flowchart of the optimal phase rotation method

## CHAPTER 4

### 4. SIMULATION RESULTS

In this chapter, we measure the performance of PAPR schemes mentioned in sections (3.1), (3.2), (3.3) and (3.4). We used the BPSK and 4QAM for the modulation of information symbols. We used MATLAB as simulation environment.

#### 4.1 Apportionment of PAPR Using CCDF

Simulation results of the PAPR reduction utilizing version different subcarriers are given. The figures below illustrate that PAPR increases when number of subcarriers are increased. The CCDF is employed for measuring the efficiency of PAPR reduction techniques. For theoretical calculation we used  $N = 64$  subcarriers, and for simulation  $N = 256, 512$  and  $1024$  are used with BPSK modulation scheme. We observed that CCDF is  $10^{-3}$  at PAPR  $10.3 \text{ dB}$  when  $N = 64$ ,  $10.9 \text{ dB}$  when  $N = 256$ ,  $11.2 \text{ dB}$  when  $512$ ,  $11.7 \text{ dB}$  when  $N = 1024$ . In Fig. 18, CCDF performance curves for different  $N$  with BPSK modulation are depicted.

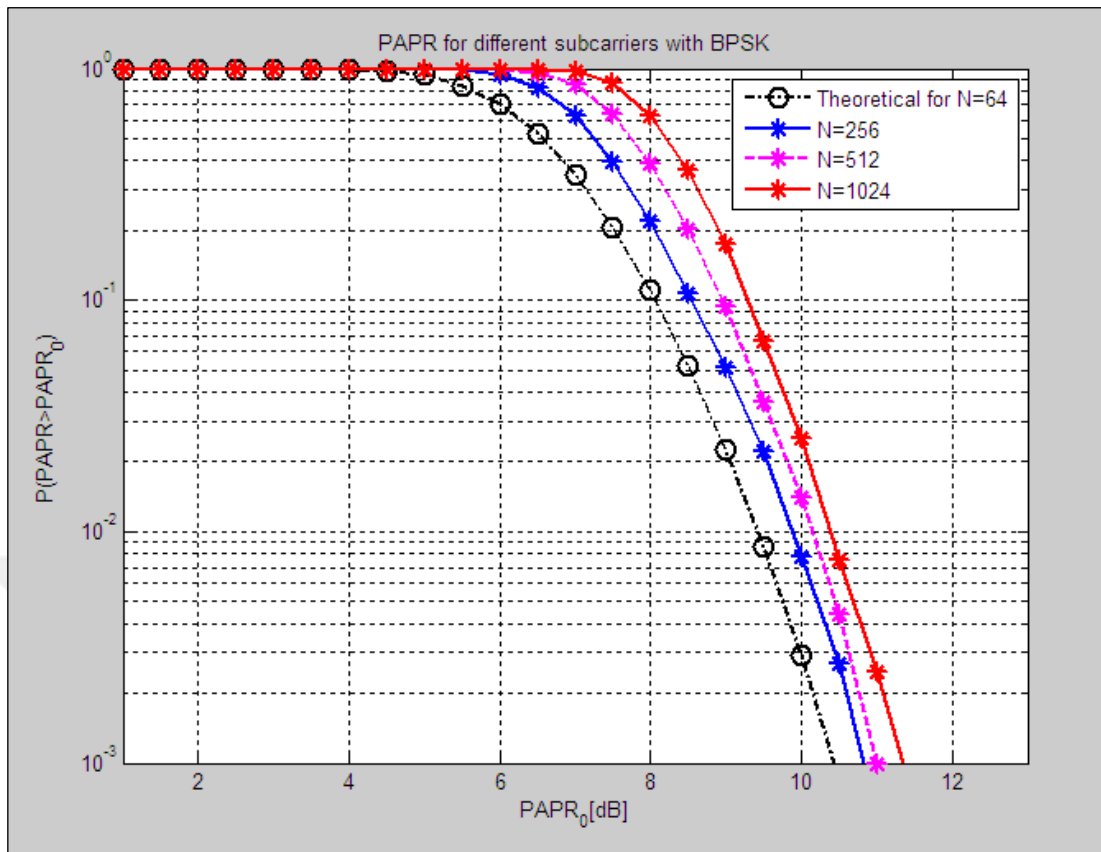

**Figure 18** CCDF curves of PAPRs for different number of subcarriers with BPSK modulation.

In another modulation scheme we used 4-QAM for modulation with different number of sub-carriers and for theoretical calculation we used  $N = 64$  and for simulations  $N = 256$ ,  $N = 512$  and  $1024$  are tried. We noticed that CCDF is  $10^{-3}$  at PAPR  $10.3 \text{ dB}$  when  $N = 64$ ,  $10.7 \text{ dB}$  when  $N = 256$ ,  $11 \text{ dB}$  when  $512$ ,  $11.6 \text{ dB}$  when  $N = 1024$ . In Fig. 19, CCDF performance curves for different  $N$  with 4-QAM modulation are depicted.

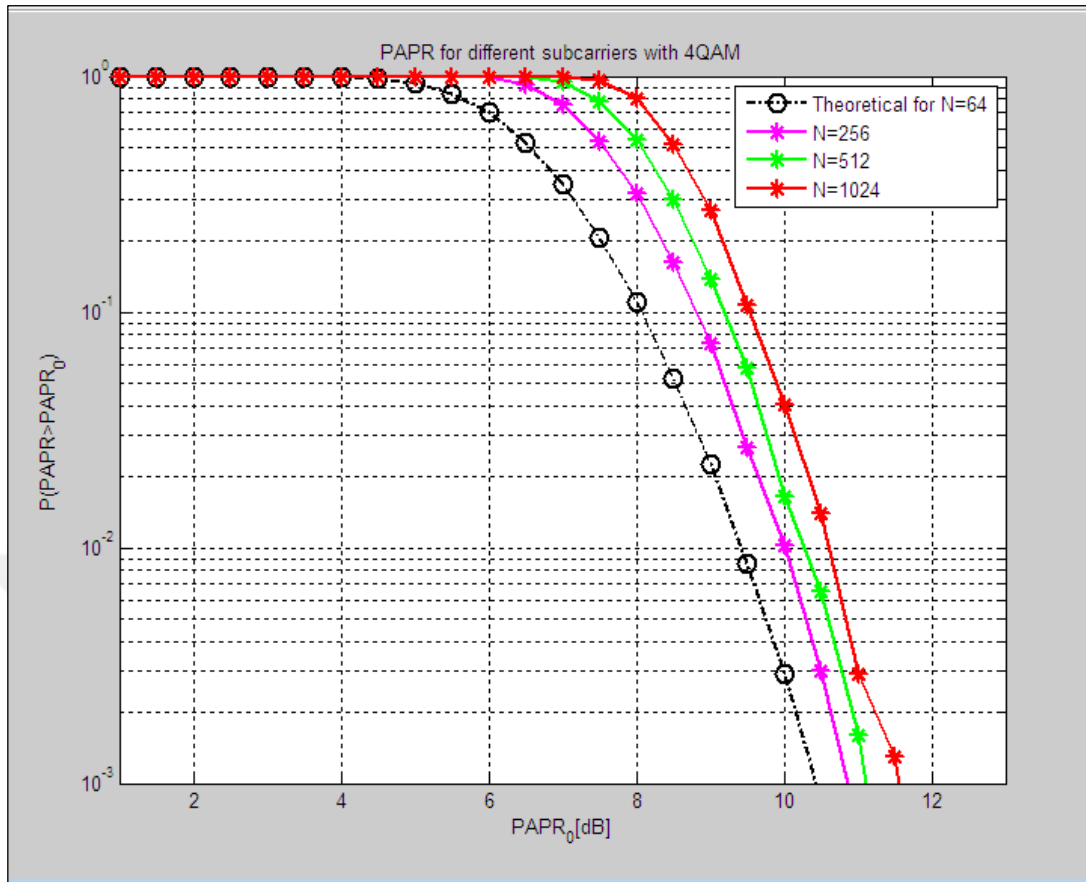

**Figure 19** CCDF curves of PAPRs for different number of subcarriers with 4-QAM modulation.

It can be concluded that PAPR increases when the number of subcarriers increase and 4-QAM gives a better result compared to the BPSK.

#### 4.2 PTS Approach for PAPR Reduction

We used PTS with two modulation scheme BPSK and 4QAM. Also, we utilized the interleaved sub-block partitioning. The PTS method requires  $V$  sub-block, and  $V * IFFT$  calculations are performed. We utilized  $V = 4$ . In Fig. 20 performance of PTS method with BPSK and 4-QAM modulation schemes are depicted in blue and

the red lines, and it is seen that CCDF is  $10^{-3}$  at 9 dB, 8.4 dB for BPSK and 4-QAM sequentially with subcarrier number  $N = 64$ . It can be concluded that the calculation PAPR with the PTS technique by utilizing the 4-QAM has given a better result compared to PTS technique that utilizes the BPSK with the same number of subcarriers.

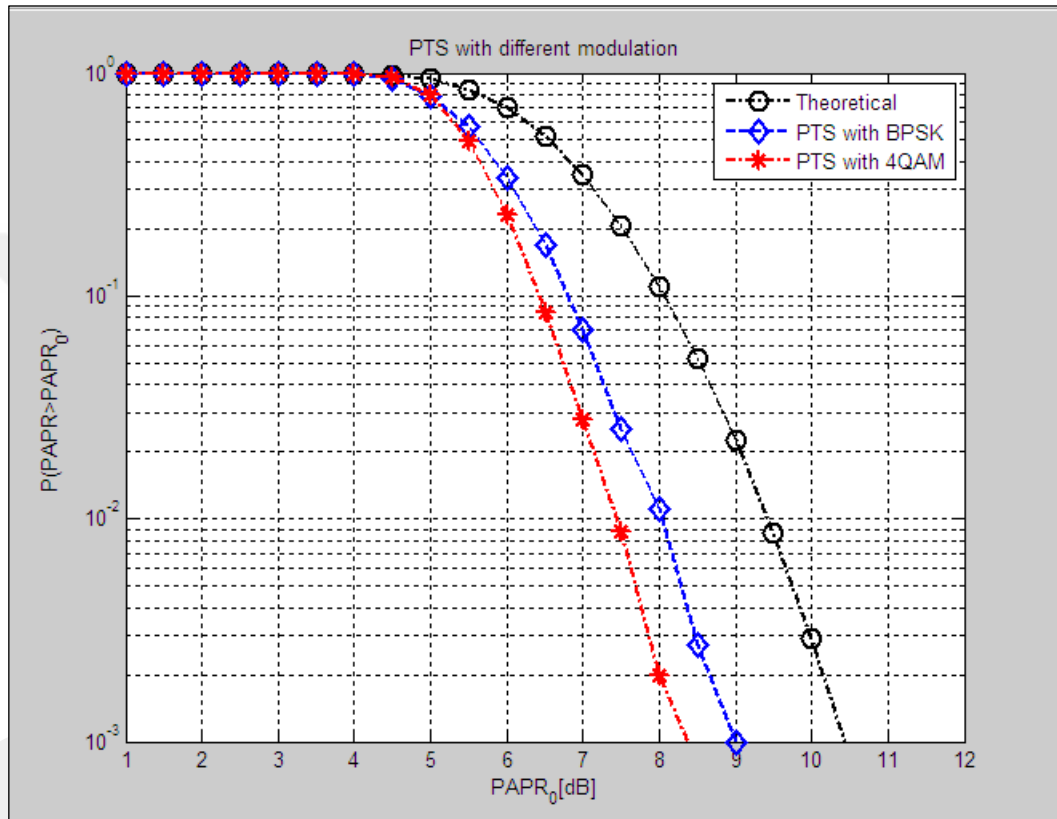

**Figure 20** Performance of PTS technique with different modulation schemes.

The performance comparison between the PTS method and the OPR method using the BPSK modulation scheme is demonstrated Fig. 21, where it is seen that OPR method is better than the PTS method. As it is seen that from Fig. 21 that CCDF is  $10^{-3}$  at the PAPR 9 dB with the PTS technique while the OPR achieves same performance at lower thresholds such that, and shows better performance as the number of phase candidates. It is seen from Fig. 21 that OPR with one candidate

rotation phase, two candidate rotation phases, three candidate rotation phases and four candidate rotation phases rotations achieves  $10^{-3}$  at  $8\text{ dB}$ ,  $7.2\text{ dB}$ ,  $6.5\text{ dB}$  and  $6.2\text{ dB}$ , respectively.

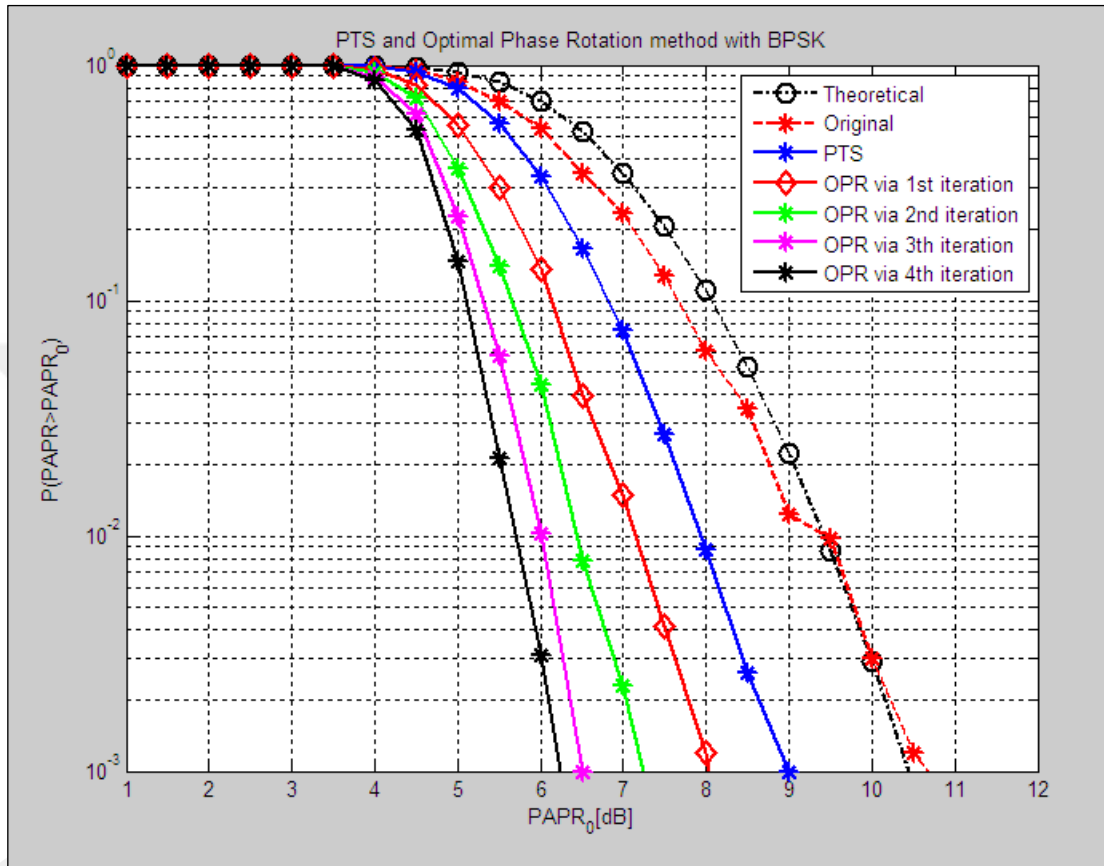

**Figure 21** Performances of PTS and OPR with BPSK

Also, the comparison between the PTS method and the OPR method by using the 4-QAM modulation scheme is illustrated in Fig. 22 where it is clear that CCDF is  $10^{-3}$  at the PAPR  $8.4\text{ dB}$  with the PTS technique while OPR achieves the same performance at lower threshold levels, i.e., OPR with one candidate rotation phase, two candidate rotation phases, three candidate rotation phases and four candidate rotation phases rotations achieves  $10^{-3}$  at  $7.8\text{ dB}$ ,  $7.2\text{ dB}$ ,  $6.9\text{ dB}$  and  $6.5\text{ dB}$ , respectively.

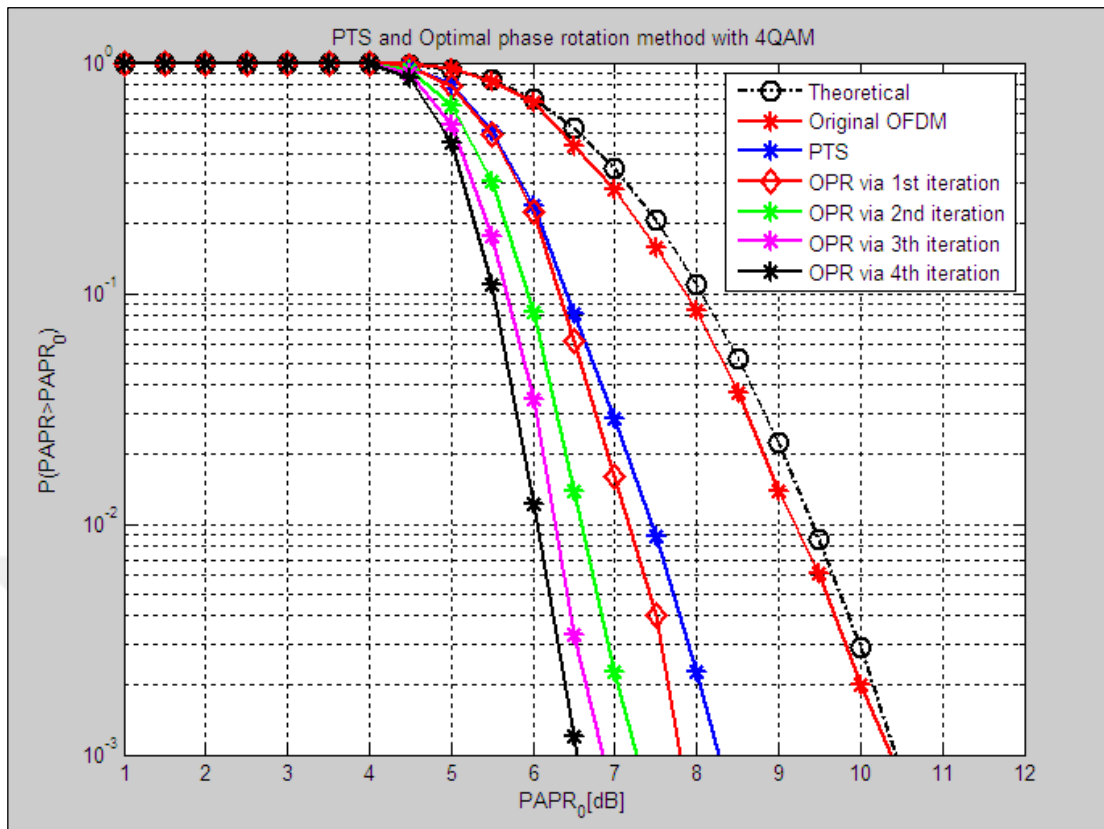

**Figure 22** CCDF Performance Curves for PTS and OPR with 4-QAM

### 4.3 The Simulation Result of Tone Injection Technique

Figure 23 demonstrates the performance of the TI and the PTS methods with 4QAM modulation. It is clear from Fig. 23 that performance PTS scheme is better than the performance of the TI scheme. Tone injection approach achieves a performance of  $10^{-3}$  at the threshold value  $9.9 \text{ dB}$ . On the other hand the same performance is achieved by PTS at the threshold value  $8.4 \text{ dB}$ . The number of subcarriers used for simulations is  $N = 64$ .

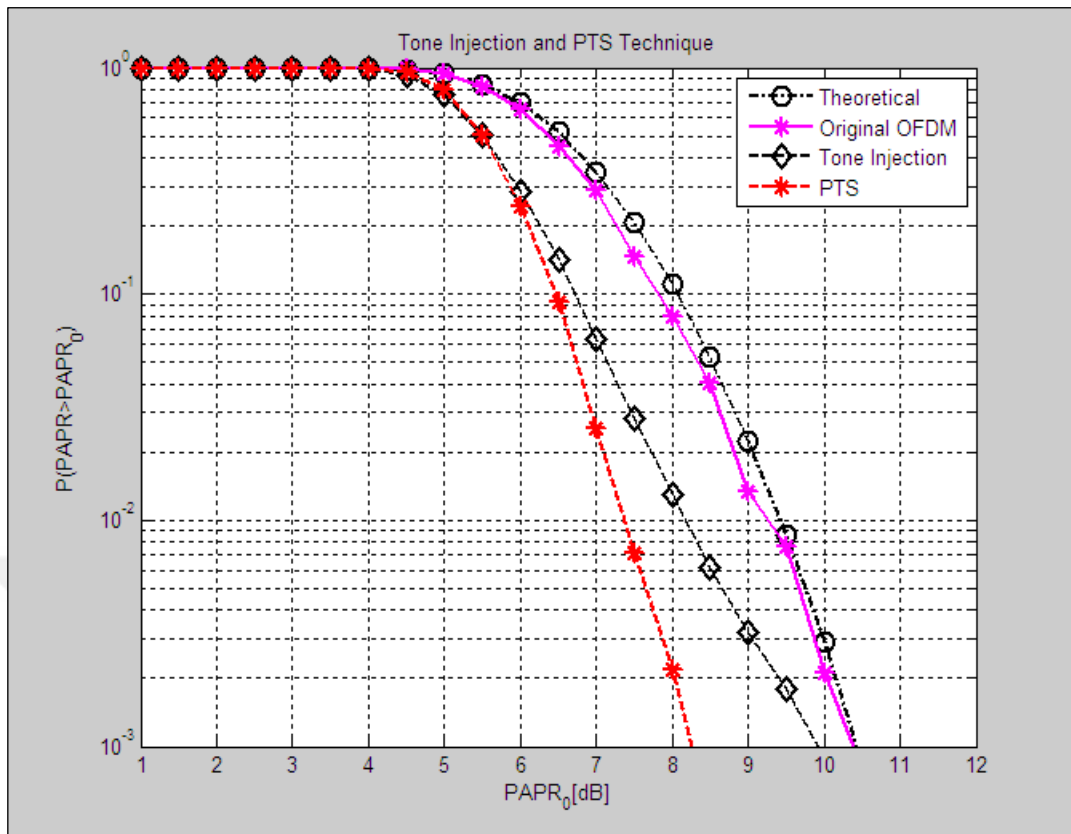

**Figure 23** Performances of TI and the PTS techniques.

The performance comparison among PTS scheme, the TI scheme and the OPR method with 4-QAM modulation scheme is illustrated Fig. 24. It is clear from Fig. 24 that CCDF with TI method has the value  $10^{-3}$  at the threshold value  $9.9 \text{ dB}$  and the same performance is with PTS method at a threshold value  $8.4 \text{ dB}$ . And the same performance is achieved by OPR method at threshold values  $7.8 \text{ dB}$ ,  $7.1 \text{ dB}$ ,  $6.7 \text{ dB}$  and  $6.5 \text{ dB}$ , depending on the number of rotation phases used. It can be concluded that OPR method utilizing the 4-QAM gives a better result compared with the PTS and the TI techniques with the same number of subcarriers.

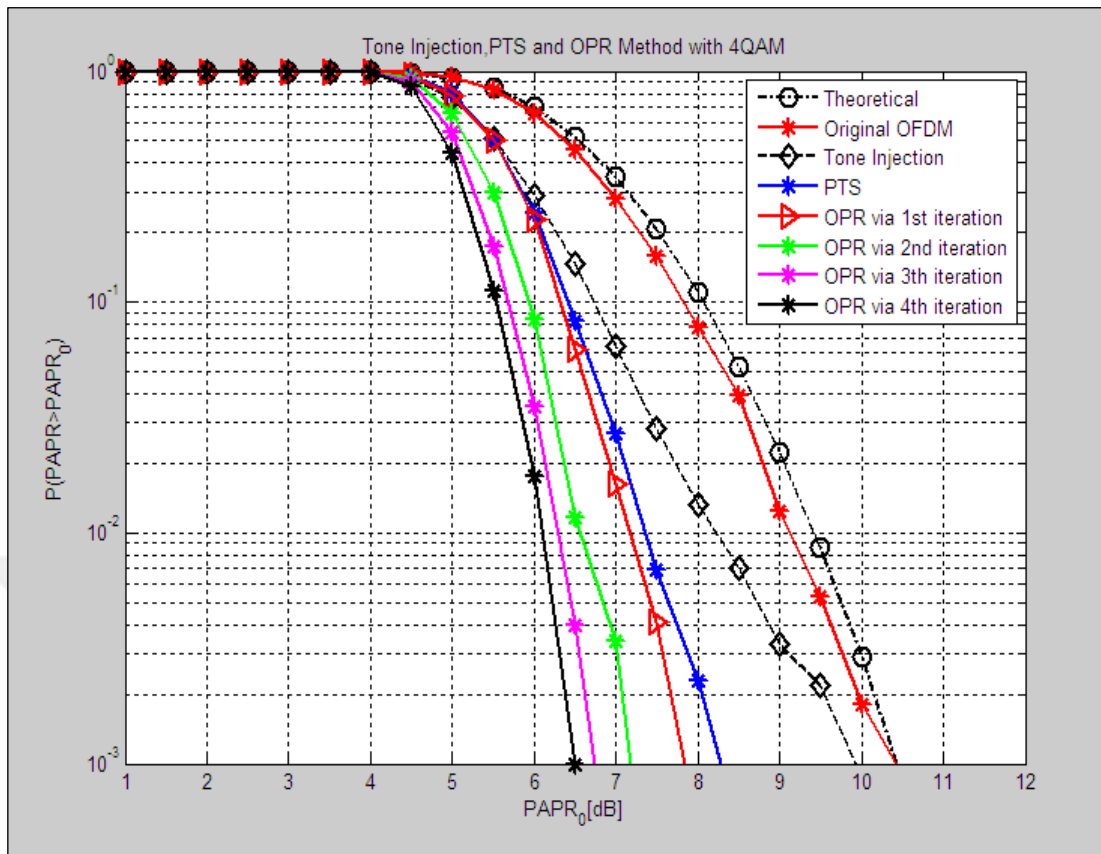

**Figure 24** PAPR Reduction Performances of TI, PTS and the OPR methods.

#### 4.4 The Simulation Result of the TR-C and the TR-K Method

The performances of the TR-C and the TR-K methods are demonstrated in Fig. 25. For TR-C and the TR-K methods 10 PRTs are used and their positions are selected as

$$R = [5, 10, 15, 20, 25, 30, 35, 40, 50, 60]$$

In Fig. 25 the magenta and the green dash line are the performance curves for the TR-C methods on the other hand the blue and the red dash lines are used to demonstrate the performance of TR-K method. When Fig. 25 is inspected we see that CCDF has a value of  $10^{-3}$  at the threshold levels 10 dB, 9.5 dB for the TR-C

method and the same performance for the TR-K method occurs for the threshold levels  $7.5 \text{ dB}$ ,  $6.8 \text{ dB}$  with the BPSK modulation and subcarrier number  $N = 64$ .

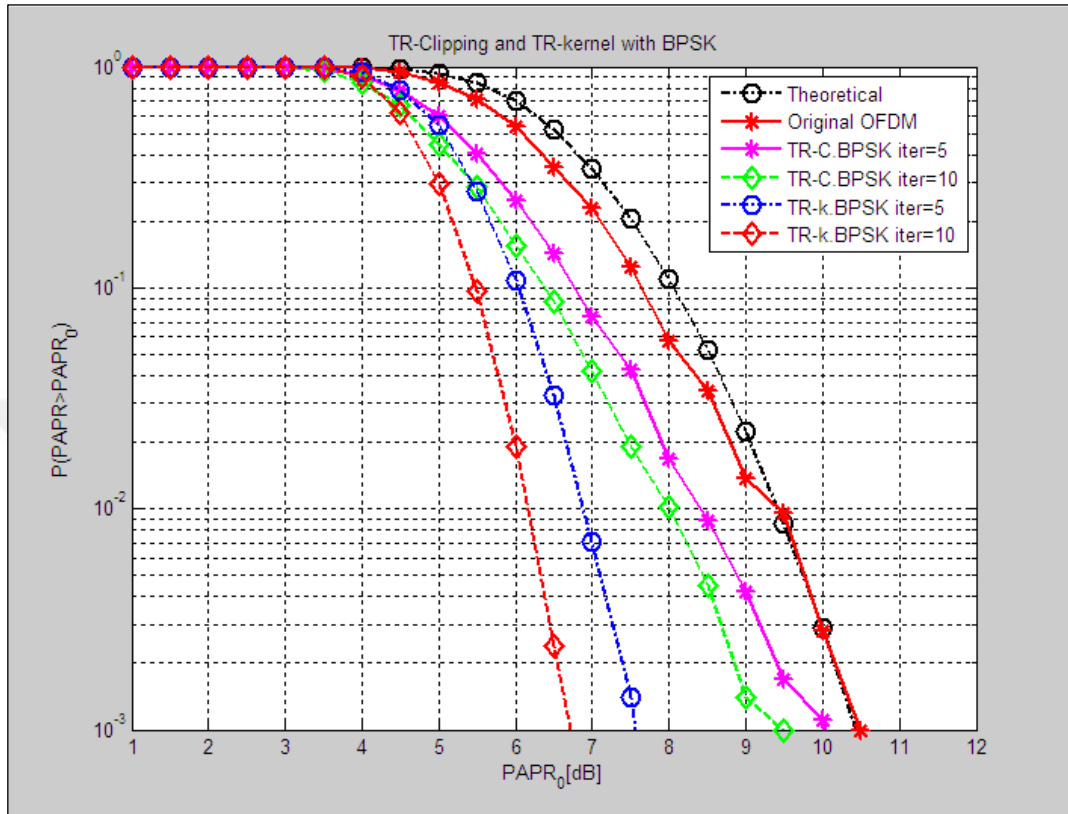

**Figure 25** Performances of TR-C and the TR-K method with BPSK modulation.

The performance comparison among the TR-C, TR-K and the OPR method with BPSK modulation scheme is demonstrated in Fig. 26 where it is seen that OPR has better performance than the TR-C method and the TR-K methods. It is clear from Fig. 26 that TR-C achieves a CCDF performance  $10^{-3}$  at the threshold levels  $9.8 \text{ dB}$  and  $9.2 \text{ dB}$  while TR-C technique has the same performance at the threshold levels, and TR-K approach gets the same performance at the threshold levels  $7.5 \text{ dB}$  and  $6.5 \text{ dB}$ , on the other hand, OPR has the same performance at the threshold levels  $7.8 \text{ dB}$ ,  $7.3 \text{ dB}$ ,  $6.4 \text{ dB}$  and  $6.1 \text{ dB}$ , depending on the number of phases tried to determine the optimum phases to be used for the rotation of subgroups consisting of

the even and odd index pairs. We used the BPSK modulation and subcarrier number is  $N = 64$ .

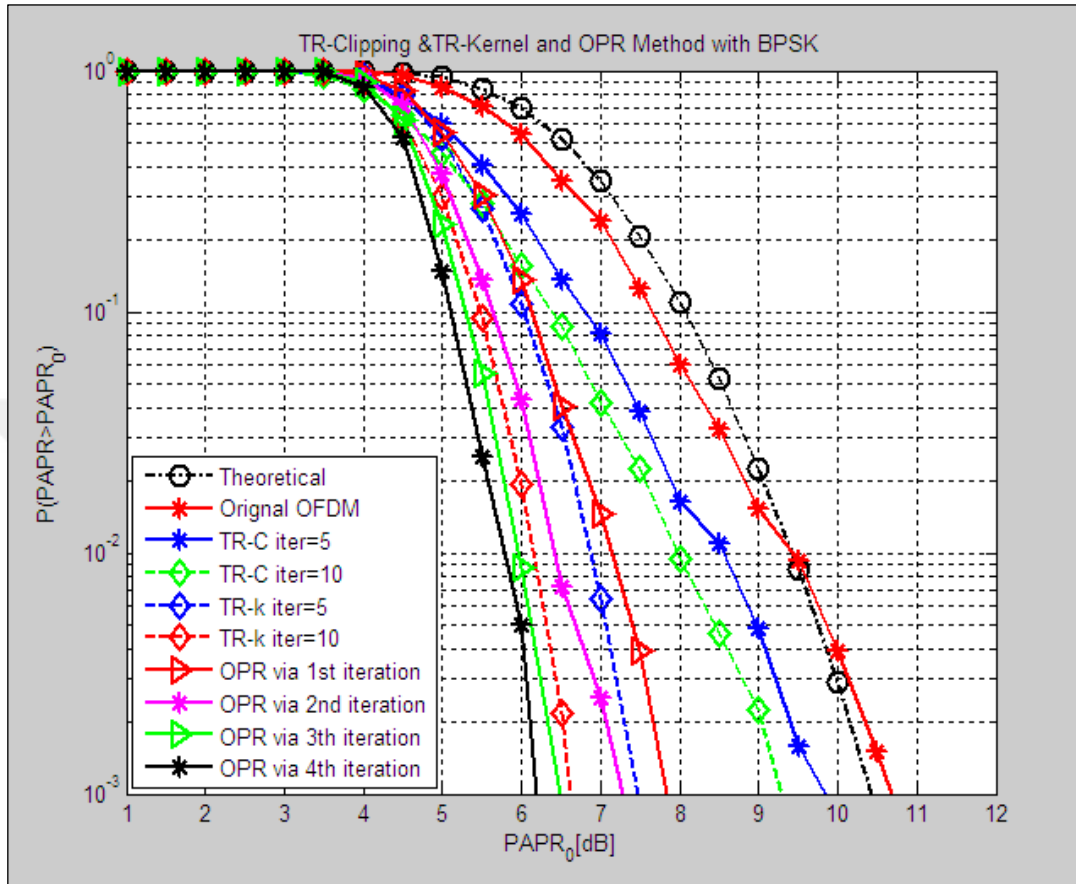

**Figure 26** Performances of the TR-C, TR-K, and OPR methods.

Also, we utilized modulation scheme 4-QAM for the TR-C and the TR-K methods and got a performance of  $10^{-3}$  for CCDF at the threshold levels  $9.2 \text{ dB}$ ,  $9 \text{ dB}$  for TR-C method and the same performance is achieved at the threshold levels  $7.4 \text{ dB}$ ,  $6.7 \text{ dB}$  for TR-K method and the same subcarriers. Simulation results for the TR-C and TR-K methods with 4-QAM are shown in Fig. 27.

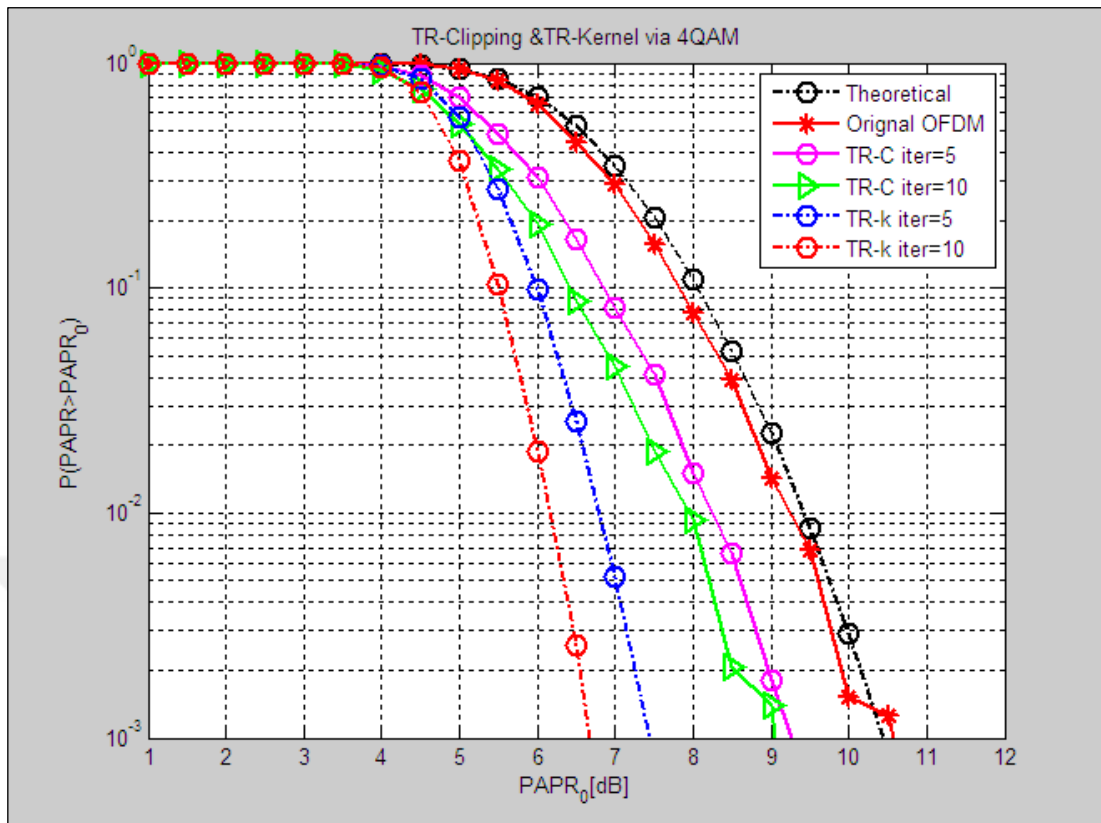

**Figure 27** Simulation results for the TR-C and TR-K methods with 4-QAM modulation scheme.

The performance comparison among the TR-C, TR-K and the OPR method using the 4-QAM modulation scheme is demonstrated in Fig. 28 where it is seen that proposed OPR method is better than the TR-C method while the performance of the OPR method is similar to that of the TR-K method. It is clear from Fig. 28 TR-C gets a CCDF performance of  $10^{-3}$  at the threshold levels  $9.6 \text{ dB}$  and  $9.1 \text{ dB}$  while TR-K gets the same performance at the threshold levels  $7.5 \text{ dB}$  and  $6.7 \text{ dB}$  and OPR method obtains the same performance at the threshold levels  $7.7 \text{ dB}$ ,  $7.1 \text{ dB}$ ,  $6.8 \text{ dB}$  and  $6.5 \text{ dB}$  depending on the number of phases used to select the optimum phases to be used for the rotation of sub-sequences. We used the BPSK modulation for our simulations and subcarrier number is chosen as  $N = 64$ .

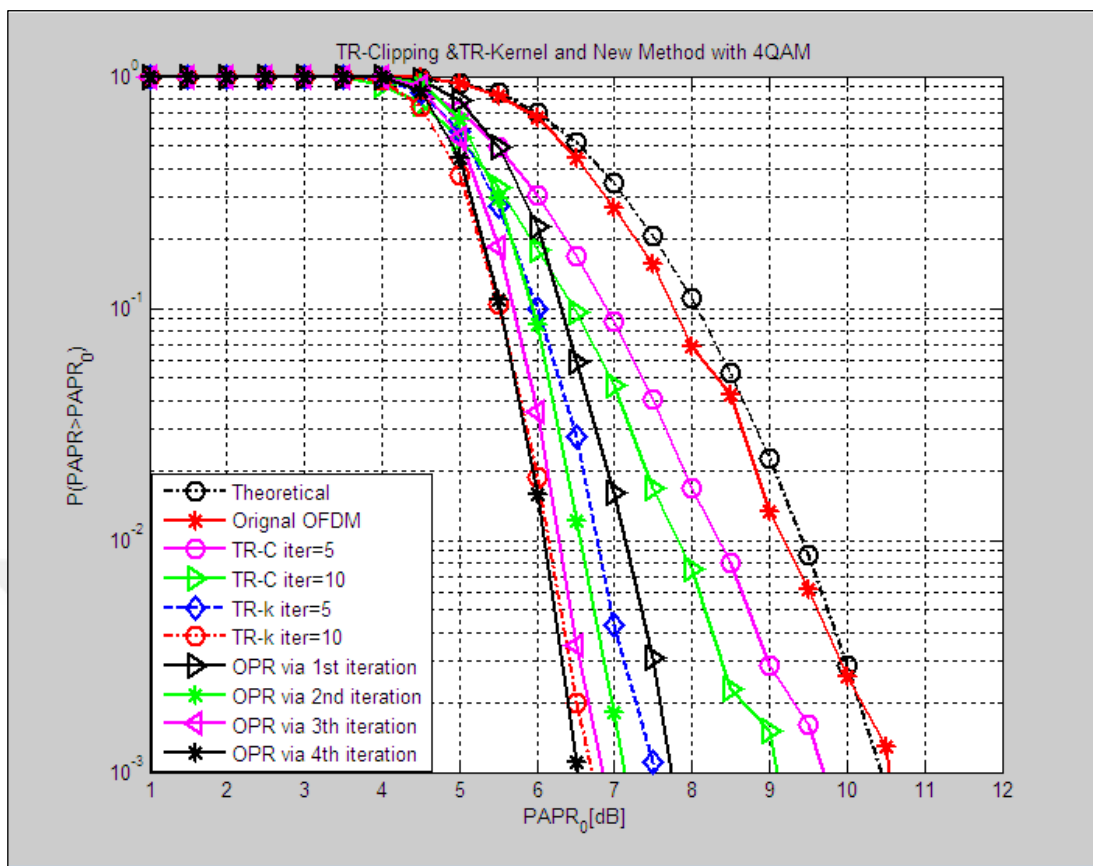

**Figure 28** CCDF performances of TR-C, TR-K, and OPR methods.

#### 4.5 Comparison of the PAPR Reduction Techniques

In this section, we have make a comparison among the PAPR techniques employing 4-QAM modulation scheme. Simulation results are demonstrated in Fig. 29. It is clear from Fig. 29 that TI method gets a CCDF performance of  $10^{-3}$  at the threshold level  $9.8 \text{ dB}$ , and TR-C method achieves the same performance at the threshold levels  $9.5 \text{ dB}$  and  $9 \text{ dB}$  while PTS gets the same performance at the threshold level  $8.4 \text{ dB}$  and TR-K method obtains the same performance at the threshold levels  $7.4 \text{ dB}$  and  $6.7 \text{ dB}$ . It can be concluded that TR-K method has better performance compared to the TR-Clipping, the Tone Injection and the PTS methods with the same number of subcarriers with 4-QAM modulation scheme.

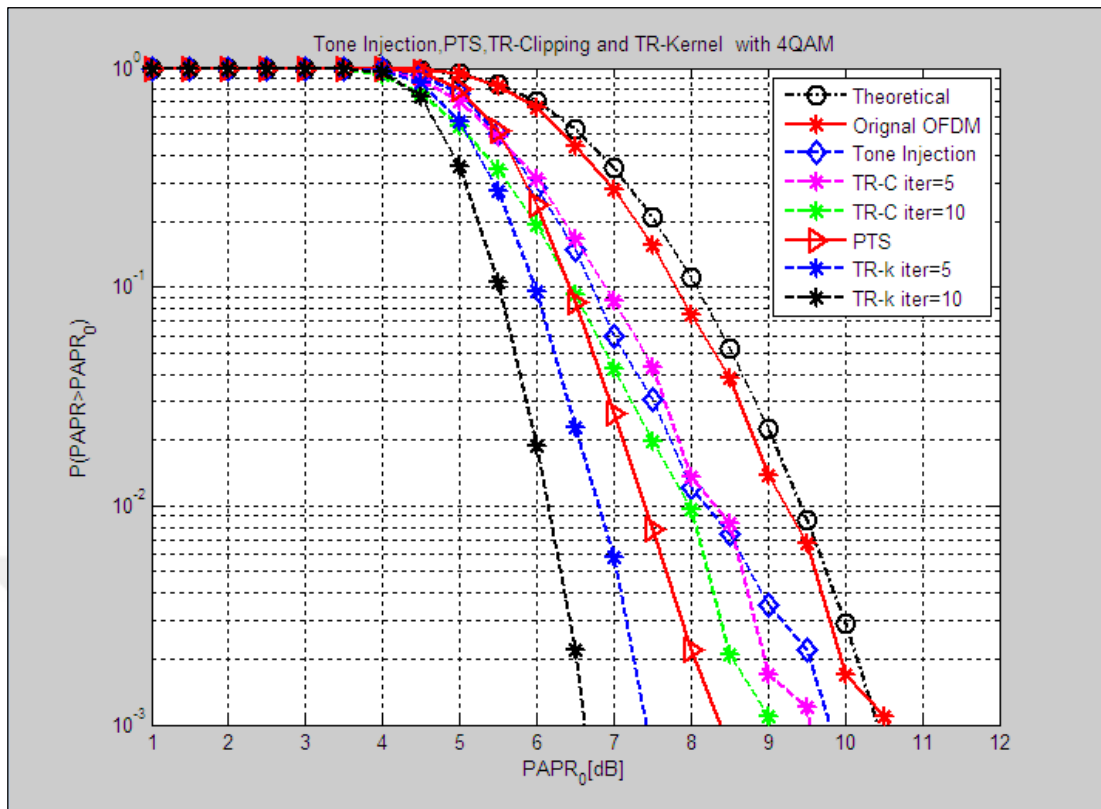

**Figure 29** Simulation of the PAPR techniques,

The performance comparison among the PTS scheme, TI, TR-C, TR-K and the proposed method by using the 4-QAM modulation scheme is illustrated in Fig. 30 where it is seen that TI gets a CCDF performance of  $10^{-3}$  at the threshold level  $9.8 \text{ dB}$ , the same performance is obtained by TR-C method at  $9.5 \text{ dB}$  by five iteration and at  $9 \text{ dB}$  by ten iteration, while the PTS method gets the same performance at  $8.4 \text{ dB}$  and TR-K method gets it at  $7.4 \text{ dB}$  by five iteration and  $6.7 \text{ dB}$  by ten iteration and lastly OPR method obtains the same performance at  $7.9 \text{ dB}$ ,  $7.1 \text{ dB}$ ,  $6.8 \text{ dB}$  and  $6.5 \text{ dB}$  depending on the number of phases employed during the determination of optimum phases. It can be concluded that the OPR utilizing the 4-QAM shows the best performance when compared to the PTS, TI, TR-C, and TR-K methods with the same number of subcarriers.

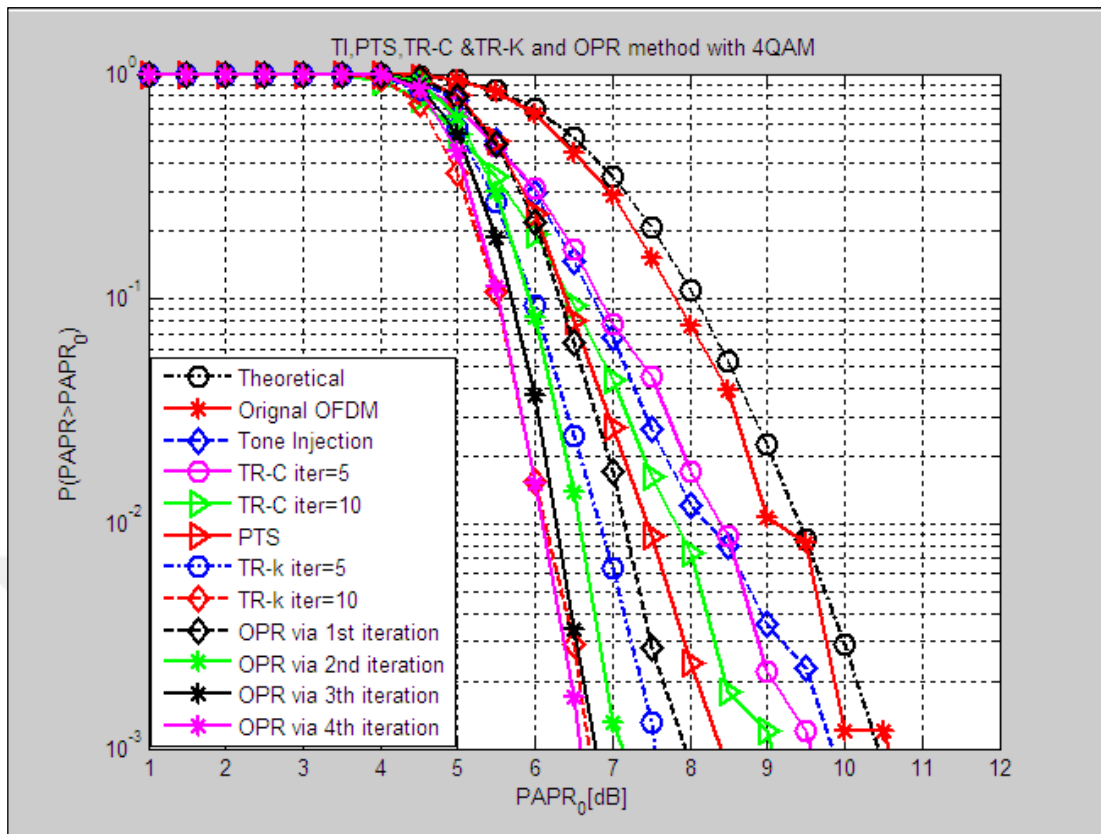

**Figure 30** Simulation results of the PAPR techniques employing 4-QAM.

## CHAPTER 5

### 5. CONCLUSION

The OFDM is an efficient communication technique used in digital multi-carrier wireless communication systems offering high-speed data rate, robustness to multipath fading, immunity to impulse interferences and high spectral capability. OFDM is able to split the bandwidth into many sub-carriers. The high PAPR of the multicarrier transmissions OFDM system is the main drawback of its use in practical communication systems. For this reason PAPR reduction techniques are employed before the transmission of the OFDM signal.

In our thesis, we inspect some the PAPR reduction methods for multicarrier transmission. These techniques are partial transmit sequence, tone injection and tone reservation which has two types of algorithm, the clipping based tone reservation and the kernel-based tone reservation. We also tried a new approach for PAPR reduction the new approach is called optimal phase rotation method in which we consider the combination of information symbols inside the OFDM symbols inspecting the internal side of the decimation in time FFT algorithm. Trying a number of phases for the subgroups of the information symbols pairs the best phases are decided to be used for the rotation of information symbols before the formation of OFDM symbols. With the proposed approach better performance with lower complexity is achieved considering the classical PAPR reduction methods mentioned.

We utilized two digital different modulations different schemes, BPSK and 4-QAM for our simulations.

## REFERENCES

- [1] Mowla, M., Ali, M., & Aoni, R. A. (2014). "Performance Comparison of Two Clipping Based Filtering Methods for PAPR Reduction in OFDM Signal". arXiv preprint arXiv:1403.3349.
- [2] Aziz, W., Ahmed, E., Abbas, G., Saleem, S., & Islam, Q. (2012). "PAPR Reduction in OFDM using Clipping and Filtering". World Applied Sciences Journal, 18(11), 1495-1500.
- [3] Sari, H., Karam, G., & Jeanclaude, I. (1995). "Transmission techniques for digital terrestrial TV broadcasting". IEEE communications magazine, 33(2), 100-109.
- [4] Schulze, H., & Lüders, C. (2005). "Theory and applications of OFDM and CDMA": Wideband wireless communications. John Wiley & Sons.
- [5] Kim, D. H., Kang, K. M., & Lee, C. (2012). "An application of MB-OFDM UWB technology for wireless speaker systems". IEEE Transactions on Consumer Electronics, 58(4).
- [6] Mahajan, K. A., & Mukhare, S. V. (2012, October). "Comparison of Signal Scrambling PAPR Reduction Techniques with Signal Distortion Techniques in OFDM Signal". In IJCA Proceedings on International Conference on Recent Trends in Information Technology and Computer Science (ICRTITCS-2011) (No. 1). Foundation of Computer Science (FCS).
- [7] Cheng, G., Li, H., Dong, B., & Li, S. (2013). "An improved selective mapping method for PAPR reduction in OFDM/OQAM system". Communications and Network, 5(03), 53.

- [8] Mountassir, J., Isar, A., & Mountassir, T. (2012, March). “*Precoding techniques in OFDM systems for PAPR reduction*”. In *Electrotechnical Conference (MELECON), 2012 16th IEEE Mediterranean* (pp. 728-731). IEEE.
- [9] Namitha.A.S and Sudheesh.P,(June 2010). “*Improved Precoding Method for PAPR Reduction in OFDM with Bounded Distortion*”, *International Journal of Computer Applications* (0975 – 8887) Volume 2 – No.7,
- [10] Jadhav, A. N., & Kutwal, M. V. (2014). “*BER and PAPR Reduction Using Companding Algorithms in OFDM*”. *International Journal of Application or Innovation in Engineering & Management (IJAIEM)*, 3(1).
- [11] KoilPandi, I., & Ram, N. V. (2014). “*Nonlinear Companding Technique in OFDM System with Different Modulation Scheme*”. *Journal of NanoScience and NanoTechnology*, 2(1), 565-569.
- [12] Xiao, Y., Bai, W., Dan, L., Wu, G., & Li, S. (2012). “*Performance analysis of peak cancellation in OFDM systems*”. *Science China Information Sciences*, 55(4), 789-794.
- [13] Gupta, P., Kumar, B. A., & Jain, S. K. (2015, January). “*Peak to average power ratio reduction in OFDM using higher order partitioned PTS sequence and Bose Chaudhuri Hocquenghem Codes*”. In *Signal Processing and Communication Engineering Systems (SPACES), 2015 International Conference on* (pp. 443-447). IEEE.
- [14] Anjaiah, C. (2015, March). “*Mu-Law companded PTS for PAPR reduction in OFDM systems. In Electrical, Computer and Communication Technologies (ICECCT)*”, 2015 IEEE International Conference on (pp. 1-4). IEEE.
- [15] Lin, P. G. (2010). “*OFDM simulation in MATLAB*”.

- [16] Rao, K. R. M., & Sravanti, T. (2014). "Performance Analysis of OFDM System Using PAPR Reduction Techniques". International Journal of Modern Engineering Research (IJMER), 1(3), 715-720.
- [17] Rahmatallah, Y., & Mohan, S. (2013). "Peak-to-average power ratio reduction in OFDM systems: A survey and taxonomy". IEEE communications surveys & tutorials, 15(4), 1567-1592.
- [18] Han, S. H., & Lee, J. H. (2005). "An overview of peak-to-average power ratio reduction techniques for multicarrier transmission". IEEE wireless communications, 12(2), 56-65.
- [19] Asseri, M. I., Tsimenidis, C. C., Sharif, B. S., & Le Goff, S. Y. (2010, July). "Orthogonal-SLM technique for PAPR reduction and recovery without side information in OFDM systems". In Communication Systems Networks and Digital Signal Processing (CSNDSP), 2010 7th International Symposium on (pp. 162-166). IEEE.
- [20] Cho, Y. S., Kim, J., Yang, W. Y., & Kang, C. G. (2010). "MIMO-OFDM wireless communications with MATLAB". John Wiley & Sons.
- [21] Li, X., Vucic, J., Jungnickel, V., & Armstrong, J. (2012). "On the capacity of intensity-modulated direct-detection systems and the information rate of ACO-OFDM for indoor optical wireless applications". IEEE Transactions on Communications, 60(3), 799-809.
- [22] Tellado, J., & Cioffi, J. M. (1998, November). "Peak power reduction for multicarrier transmission". In IEEE GLOBECOM (Vol. 99, pp. 5-9).

- [23] **Wattanasuwakull, T., & Benjapolakul, W. (2005, December).** “*PAPR Reduction for OFDM Transmission by using a method of Tone Reservation and Tone Injection*”. In Information, Communications and Signal Processing, 2005 Fifth International Conference on (pp. 273-277). IEEE.
- [24] **Latinovic, Z., & Bar-Ness, Y. (2006).** “*SFBC MIMO-OFDM peak-to-average power ratio reduction by polyphase interleaving and inversion*”. IEEE communications letters, 10(4), 266-268.
- [25] **Botlik, B., & Kollár, Z. (2014).** “*Comparison of the performance of tone reservation based PAPR reduction techniques*”.
- [26] **Mroué, M., Nafkha, A., Palicot, J., Gavalda, B., & Dagorne, N. (2010).** “*Performance and implementation evaluation of TR PAPR reduction methods for DVB-T2*”. International journal of digital multimedia broadcasting, 2010.
- [27] **Jiang, T., Qu, D., & Gao, P. (2010, March).** “*Distribution of peak-to-average power ratio and its applications in OFDM systems with unequal power allocation*”. In Wireless Internet Conference (WICON), 2010 the 5th Annual ICST (pp. 1-9). IEEE.
- [28] **Wei, S., Goeckel, D. L., & Kelly, P. A. (2010).** “*Convergence of the complex envelope of bandlimited OFDM signals*”. IEEE Transactions on Information Theory, 56(10), 4893-4904
- [29] **Chow, P. S., Tu, J. C., & Cioffi, J. M. (1991).** “*Performance evaluation of a multichannel transceiver system for ADSL and VHDSL services*”. IEEE journal on selected areas in communications, 9(6), 909-919.
- [30] **Monk, A., Lee, R., & Hebron, Y. (2013).** “*The multimedia over coax alliance*”. Proceedings of the IEEE, 101(11), 2322-2338.

## CURRICULUM VITAE

### PERSONAL INFORMATION

Surname, Name: Wisam Hasan ALI

Nationality: Iraqi

Date and Place of Birth: 31 May 1986, Diyala

Marital Status: Married

Phone: +90 5386995625

E-mail: wisasamalazzawy@gmail.com



### EDUCATION

Degree	Institution	Year of Graduation
M.Sc	Çankaya University Electronic and Communication Engineering	April 2017
B.Sc	Diyala University Communication Engineering	June 2010