



**OPTIMIZING ENERGY CONSUMPTION IN WIRELESS SENSOR
NETWORKS BY USING LINEAR PROGRAMING EQUATIONS**

ZAID RAAD SABIR SABIR

FEBRURAY 2017

**OPTIMIZING ENERGY CONSUMPTION IN WIRELESS SENSOR
NETWORKS BY USING LINEAR PROGRAMING EQUATIONS**

**A THESIS SUBMITTED TO
THE GRADUATE SCHOOL OF NATURAL AND APPLIED
SCIENCES OF
ÇANKAYA UNIVERSITY**

**BY
ZAID RAAD SABIR SABIR**

**IN PARTIAL FULFILLMENT OF THE REQUIREMENTS FOR THE
DEGREE OF
MASTER OF SCIENCE
IN
THE DEPARTMENT OF
COMPUTER ENGINEERING**

FEBRURAY 2017

The title of the Thesis: **Optimizing Energy Consumption in Wireless Sensor Networks by using Linear Programming Equations.**

Submitted by **ZAID RAAD SABIR SABIR**

Approval of the Graduate School of Natural and Applied Sciences, Çankaya University.

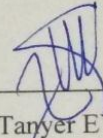

Prof. Dr. Halil Tanyer EYYÜBOĞLU
Director

I certify that this thesis satisfies all the requirements as a thesis for the degree of Master of Science.

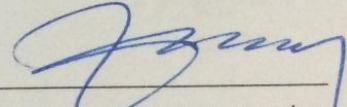

Prof. Dr. Hüseyin Selçuk GEÇİM
Entrusted to Head of Department

This is to certify that we have read this thesis and that in our opinion; it is fully adequate, in scope and quality, as a thesis for the degree of Master of Science.

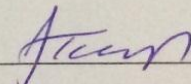

Assist. Prof. Sibel TARIYAN ÖZYER
Supervisor

Examination Date: 07.02.2017

Examining Committee Members

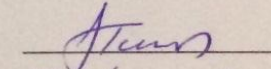
Assist. Prof. Sibel TARIYAN ÖZYER (Çankaya Univ.) 

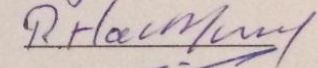
Assist. Prof. Reza Zare HASSANPOUR (Çankaya Univ.) 

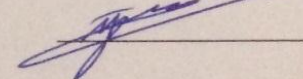
Assist. Prof. Uğur BAÇ (Atılım Univ.) 

STATEMENT OF NON-PLAGIARISM PAGE

I hereby declare that all information in this document has been obtained and presented in accordance with academic rules and ethical conduct. I also declare that, as required by these rules and conduct, I have fully cited and referenced all material and results that are not original to this work.

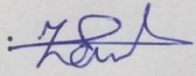
Name, Last Name : Zaid SABIR
Signature : 
Date : 07.02.2017

ABSTRACT

OPTIMIZING ENERGY CONSUMPTION IN WIRELESS SENSOR NETWORKS BY USING LINEAR PROGRAMING EQUATIONS

SABIR, Zaid Raad Sabir

M.Sc. Department of Computer Engineering

Supervisor: Asst. Prof. Sibel TARIYN ÖZYER

February 2017, 52 pages

Wireless Sensor Networks (WSNs) it is set of sensors deployed in a specific geographic area to sensing particular action, then relays the data to one or more base station to manage it and take actions. Sensors are tiny devices supported with limited power source generally, represented by the battery. These sensors are designed to work in unattended fields for a long time months or years. So sensor life is the most important factor in the network. We have to extend sensor lifetime as much as possible to prolong the network lifetime. Hence the network lifetime can be defined as a time from running the network till they die off first nodes in the network. Therefore, we try to make energy consumption in the network that is controlled and balanced among sensors, avoiding dies one or more sensor before the others. Many methods and manners can be used to save energy and improve network lifetime, such as data aggregation, mobile nodes, transmission power control, node deployment, and clustering.

In this thesis, the problem of “unbalance energy consumption” has been studied to maximize network lifetime as much as possible in the wireless sensor networks. In such networks, all sensor nodes collect and transmit data to one base station through multi-hop communications. The nodes deployment is uniform. This situation generates heavy traffic load in the nodes near to the base station. In this study, a linear program (LP) method has been studied for modeling the theoretical features of the uniform node distribution strategies in wireless sensor networks. Our results indicated that node deployment and base station location have significant effects on the energy consumption of sensor nodes. Proposed node deployment models can affect the energy consumption and can balance energy depletion between sensor nodes.

Keywords: Wireless Sensor Network, Network lifetime, Node deployment, Linear Programming.

ÖZ

KABLOSUZ ALGILAYICI AĞLARDA DOĞRUSAL PROGRAMLAMA DENKLEMLERİ KULLANARAK ENERJİ TÜKETİMİ EN İYİLEMESİ

SABİR, Zaid Raad Sabir

Yüksek Lisans, Bilgisayar Mühendisliği Anabilim Dalı

Tez Danışmanı: Yrd. Doç. Dr. Sibel TARIYAN ÖZYER

Şubat 2017, 52 Sayfa

Kablosuz Algılayıcı Ağlar (KAA), belirli bir coğrafi alanda dağılmış özel işi algılama olan sensörler kümesidir, ayrıca veriyi yönetebilmek ve iş yapabilmek için bir ya da daha fazla baz istasyonuna veriyi aktarır. Algılayıcılar, genellikle sınırlı enerji kaynakları ile destekli çok küçük aygıtlardır. Bu algılayıcılar, uzun bir zaman aylar ya da yıllar gözetimsiz alanlarda çalışmak için tasarlanmıştır. Dolayısı ile algılayıcı yaşamı, ağda en önemli faktördür. KAA yaşam ömrünü uzatabilmek için algılayıcı yaşam ömrünü mümkün olduğu kadar fazla uzatmak zorundayız. Bunun sonucu olarak, ağ yaşam süresi ilk düğüm ölünceye kadar ağın çalışma zamanı olarak tanımlanabilir. Buna bağlı olarak, bir algılayıcının diğerlerinden önce ölmesini engelleyerek, ağdaki algılayıcılar tarafından control edilen ve dengelenen enerji tüketimini sağlamaya çalışmaktayız. Enerjiyi korumak ve ağ yaşam süresini artırmak için; veriyi bir araya getirme, gezici düğümler, güç control iletimi, düğüm dağılımı ve kümelenme gibi bir çok yöntem ve usuller kullanılabilir.

Bu tezde, kablosuz algılayıcı ağlarda “dengelenmemiş enerji tüketimi” mümkün olan en büyük dereceye yükseltilmesi çalışılmıştır. Bu tarz ağlarda, tüm algılayıcı düğümler veriyi baz istasyonuna çoklu sekme vasıtası ile toplarlar ve iletirler. Düğüm dağılımı geniş ölçüde tek düzedir. Bu durum baz istasyonu yakınında yoğun trafik yükü yaratır. Bu çalışmada, tekdüze düğüm dağılımı stratejileri teorik özelliklerini modellemek için Doğrusal Programlama (DP) yöntemi çalışılmıştır. Çalışmalarımız, algılayıcı düğümlerin enerji tüketiminde; düğüm dağılımı ve baz istasyonu yerinin önemli ekilere sahip olduğunu belirtmektedir. Önerilen düğüm dağılım modelleri, algılayıcı düğümler arasında enerji tüketimini etkileyebilir ve enerji eksilmesini dengeleyebilir.

Anahtar Kelimeler: Kablosuz algılayıcı ağlar, Network yaşam süresi, Düğüm Dağılımı, Doğrusal programlama.

ACKNOWLEDGEMENTS

Firstly, I am grateful to Allah for giving me the good health and wellbeing that were necessary to complete this thesis.

I would like to thank my supervisor, Assist. Prof. Dr. Sibel TARIYAN ÖZYER, for her guidance and encouragement. Her supports brought this work to a completion. This work came into existence with her supervision. There is no enough word to thank for her guidance.

I would like to thank Prof. Dr. Halil Tanyer EYYÜBOĞLU, who is the director of the graduate school of natural and applied sciences at Çankaya University, for all support and motivation throughout my master program.

I deeply thank my parents Mawa AL_HAJEAT and Raad ZUBAIR. They raised me, supports me, and loved me. To them, I dedicate this thesis.

I would like to thank my lovely wife Lina YASEEN who have always stood by me in the worst of time and supported me in all manners during my master program. None of this would have been possible without her love and patience. I also dedicate this thesis to them.

The last great thank to my brother Mohammed ZUBAIR, and my sisters Marwa ZUBAIR, Tamara ZUBAIR who supported me, encourage me and loved me.

TABLE OF CONTENTS

STATEMENT OF NONPLAGIARISM.....	iii
ABSTRACT.....	iv
ÖZ.....	vi
ACKNOWLEDGEMENTS.....	viii
TABLE OF CONTENTS.....	xi
LIST OF FIGURES.....	xii
LIST OF TABLES.....	xiii
LIST OF ABBREVIATIONS.....	xiv
CHAPTERS:	
1. INTRODUCTION.....	1
1.1. Thesis Motivation.....	2
1.2. Thesis Contributions	3
1.3. Thesis Organization	3
2. BACKGROUND INFORMATION ABOUT WIRELESS SENSOR NETWORKS.....	4
2.1. Introduction	4
2.2. Architecture for Wireless Sensor Nodes.....	5
2.2.1. The Microcontroller	5
2.2.2. The Sensor	6
2.2.3. Power Unit	6
2.2.4. The Memory	6
2.2.5. The Transceiver	6
2.3. Types of Sensors	7
2.4. Protocol Stack for WSNs	8
2.5. Flowchart for Operation Sensor in The Node	9

2.6.	Topologies used for Data Aggregation in of WSN	10
2.7.	Wireless Sensor Network Standard and Statistics	11
2.8.	Applications of Wireless Sensor Network	13
2.9.	Power Consumption in WSNs	16
3.	LITERATURE REVIEW	18
3.1.	Unbalance Energy Consumption	18
3.2.	Solving Unbalance Energy Consumption.....	19
3.2.1.	Clustering nodes	21
3.2.2.	Movable nodes	24
3.2.3.	Manage data collecting	26
3.2.4	Nonuniform deployment	28
3.2.5.	Transmission Power Control	30
4.	USING OPTIMIZATION IN WIRELESS SENSOR NETWORKS.....	33
4.1.	Optimization	33
4.2.	The scope of Optimization Problems.....	33
4.3.	Maximization and Minimization Values.....	34
4.4.	Classification of Optimization Problems.....	35
4.5.	Linear Programming	36
4.6.	Planning Process for Optimization Problems.....	36
4.7.	Optimization Process	36
4.8.	Optimization in Wireless Sensor Networks.....	37
4.9.	Optimization domain in Wireless Sensor Networks	39
4.10	Simulation Tools Used To Optimize WSNs	39
4.11	GAMS	40
4.12	Structure Models of GAMS.....	40
5.	SYSTEM MODEL	42
5.1.	Introduction	42
5.2.	Network Assumptions.....	42
5.3	Nodes Deployment Model	43

5.4	Energy Model	44
5.5	Network Lifetime	44
5.6	Model's Equations	45
5.6.1	Normal Equations.....	45
5.6.2.	Linear Programing Equations	46
5.7	Simulation and Results	47
6.	CONCLUSION.....	48
REFERENCES.....		R1
APPENDICES.....		A1
A.	CURRICULUM VITA.....	A1

LIST OF FIGURES

FIGURES

Figure 1	The architecture of Wireless Sensor.....	5
Figure 2	Wireless Sensor Network Protocol Stack.	8
Figure 3	Flowchart of Sensor Operations.	10
Figure 4	Wireless Sensor Network Topologies	11
Figure 5	Global industrial field instrument shipments wired and wireless	12
Figure 6	WSN revenue growths in all industries.	12
Figure 7	Applications of wireless sensor networks.	13
Figure 8	Market size of WSNs and the cost of manufacturing.....	14
Figure 9	Implementation of WSN in Detection of Volcanic Activity.....	15
Figure 10	Using WSNs in Architecture of a Bushfire Detection System...	15
Figure 11	The power consumption of in different types of sensors.....	16
Figure 12	Power consumption, according to sensor modes.....	17
Figure 13	The problem of energy hole problem.	19
Figure 14	Data Aggregation techniques in WSNs.	27
Figure 15	Optimization process.	33
Figure 16	Optimization domains in WSNs.	39
Figure 17	Random deployments of wireless sensor nodes.	35
Figure 18	Distribute nodes over linear topology.	36
Figure 19	The effect of distance on network lifetime in linear topology....	36
Figure 20	The effect of data flows on network lifetime in a linear topology.	37
Figure 21	Distribute nodes randomly over circle area.	41
Figure 22	The effect of Radius on network lifetime in circular area.....	42

LIST OF TABLES

TABLES

- Table 1** The effect of distance on network lifetime in linear topology
- Table 2** The effect of data flow on network lifetime in linear topology
- Table 3** The effect of Radius on network lifetime in circle topology

LIST OF ABBREVIATIONS

ADC	Analog to Digital Converter
BS	Base Station
GAMS	General Algebraic Modeling System
IC	Integrated Circuit
J	Joule
LP	Linear Programming
OSI	Open Systems Interconnection
QoS	Quality of service
TCP	Transmission Power Control
WSN	Wireless Sensor Network

CHAPTER 1

INTRODUCTION

Sensors exist in every place. Sensors used in tools, industry, and even in the smart phones. Although, that the sensors around us, researchers did not do research on WSNs till 1980. The wireless sensors manufactured in 2001, then it used in industrial and many fields.

A sensor networks can be described by a set of sensor node working with each other to collect information by sensing surroundings. Then the base station will receive these data from nodes to make a specific action. The expansion in memory, processor, radio technology, as well as the low price of manufacture IC, led to the widespread use of the sensors in WSNs.

Wireless Sensor Networks firstly used in the military side like most of the new engineering sciences in the universe. Then this technology deployed in a broad scope of civilian side, it entered in many applications like environmental monitoring, habitat monitoring, home, structural monitoring and wellness monitoring. Wireless sensor network extremely used for the important reason that the sensor is smaller and production costs have become fewer.

The primary challenge in WSNs is the energy consumption. A sensor node is very small and the battery is the energy origin in it. The applications of sensor networks demand a long network lifetime, but as we know that the capacitance of the batteries limited, this is one of the critical challenges in the design of the wireless sensor network, how to manage the energy in an efficient way because, we cannot change the batteries of 100 -

1000 sensors in the network. On the other hand, nodes are distributed in unreachable places in some applications. From this we conclude: energy consumptions in a sensor must be strictly supervised for limitation in its energy. The running time in sensor related with the amount of its energy that effect on network lifetime. Finally, the network will stay active till the first node finished its energy.

1.1 Thesis Motivation

Our goal of this study is to maximize the Wireless Sensor Network's lifetime, to satisfy this aim each node in the network have to use its energy accurately during execute its job. Moreover, the degree of energy used up in all nodes has to be devised. The energy level for all nodes has to reduce concurrently, to take advantage of the energy in the node's battery. Optimization applied to balance the energy depletion in sensor nodes to avoid dies node before the others. This optimization contributes to maximize the lifetime of the sensor network.

Sensors perform three different jobs during its lifetime. First one is accomplishing the sensing task of collecting sensed data. Second, sometimes it doing some cognitive process or execute some algorithms before the succeeding tone. Third, it delivers the data to sink. In WSNs the data in sensors have to deliver to the base station this action can be direct if the sink is in the range of sensing or the data delivered hope by hope till reaching the sink. In nodes energy consumed in many actions such as sensing, transmitting its data, and relying data coming from other nodes.

The node deployment model is too important in WSNs lifetime. If the sensor deployment was careless the energy consumers will be random also this deployment will cause unbalancing in energy consumers. So some nodes will use its battery faster than other nodes, which caused die the network quickly. In sensor networks generally, the node deployment either deterministic or random. In parallel random deployment also divided into two type uniforms and non-uniform deployment models. From here we will use random deployment as well as optimization theory for saving energy and expand the network lifetime.

1.2 Thesis Contributions

In our thesis, we contribute to three factors. Firstly, we deployed sensor node on linear area methodically. To observe the effects of length between the base station and clients along the network lifetime and finding the maximum network lifetime for every scenario. Secondly, this chair also applied to a linear area, but this time to find the data flow between nodes and base station and its effect on network lifetime. Thirdly, contribute in finding optimum network lifetime but this time applied to the two-dimensional area (Circular area). This result has found by using specific linear programing equations.

1.3 Organization of Thesis

Our thesis consists of six chapters:

Chapter One is the introduction

Chapter Two explains the components of WSNs to give information to the reader.

Chapter Three explains unbalancing energy consuming problem in WSN energy consumption and presents literature survey the solution for these problems.

Chapter Four presents the Optimization and it's used for wireless sensor networks.

Chapter Five applies our model to maximize the network lifetime.

Chapter Six, concludes our study.

CHAPTER 2

BACKGROUND INFORMATION ABOUT WIRELESS SENSOR NETWORKS

2.1 Introduction

The Wireless sensor networks consist of a specific number of nodes, each one supplied with a wireless interface connected and interconnected to each other. The size of the sensing area varies according to the application and geographic region that coverage, it can be a meter to thousands of kilometers. The main impact of the WSN is through the spread coordinated of sensing, processing, and networking by all the sensor nodes, these ways helps to overcome the limitations in resources of each node.

The operation and design of a WSN encompass several fields, such as, embedded systems, network, database management, distributed algorithms, digital signal processing, data acquisition, and distribution methods.

Size, power, and cost of the sensor node is not fixed. They are based on the type of sensors and the applications. Node's properties such as, flexibility and scalability, allow them to deploy efficiently in any environment for the purpose of monitoring through sensing. They are specially designed to operate in limited maintenance; this makes them suited for critical environments.

During the study of WSNs, we have to focus on important factors related with nodes such as, the architecture, types, utilize and deployment.

2.2 Architecture for Wireless Sensor Nodes

The architecture of a sensor node shown in the Figure 1. The ingredients and many details had explained, about components of wireless sensor networks [1].

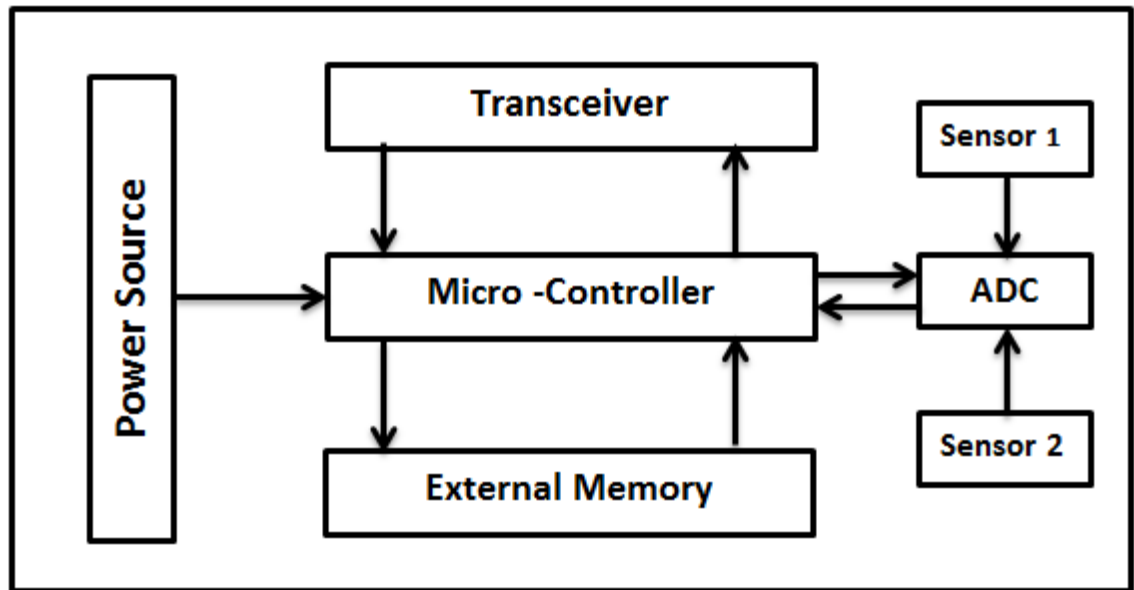

Figure 1 Architecture for Wireless Sensor

2.2.1 The Microcontroller

It is used to execute a set of operations in the nodes such as control and process. The Microcontroller is cheap, easy in installed and program, and consumes very low energy, so it is used in a wide range of systems one of them is sensor nodes. The Microcontroller used instead of microprocessors because it usually needs a lot of energy as a comparison with the Microcontroller. Therefore, it is suitable to use in sensor nodes.

2.2.2 The Sensor

It is device respond to specific physical changes in the environment, according to a physical condition in its design. Moreover, it produces electrical signals according to event. The sensing is environmental parameters such as, motion, gas, and light. Sensors transfer the sensing information to an analog signal, then transfer it to a digital signal. The information represented by digital signal sends to the microcontroller. The converting process is performed by using Analog to Digital Converter (ADC). Sensors are small in size and have to use as less as possible of the battery.

2.2.3 Power Unit

Batteries are the most common energy source in nodes. Solar panels or renewable technology is used to recharge batteries to support all parts of nodes by energy and extend its lifetime.

2.2.4 The Memory

Generally, nodes used memory in the microcontroller due to energy limitation. External memory also used in sensors and the most memories used are flash memory because of its cost and storage capacity. RAM used as Previous Programing memories also employed in sensor node. These Memories used for storing configuration and sets.

2.2.5 The Transceiver

It is responsible for sending and receiving data as a signal. It works in many modes transmit, receive and sleep mode. The transmission mode is most power consumption modes.

The transmission medium that allowed to use is RF, laser or infrared. Lasers are the lowest energy consumption, but it has to work in the specific conditions, for example, need a special foundation also sensitive to environmental conditions but this environment very rare to get. Infrared, do not need an antenna, but it has problems with the limit of broadcasting capacity. The most used transmission medium in wireless communication are radio frequency and use set of free frequencies license. In a wireless sensor node, power consumed in three tasks sensing, data processing, and communication. Data communication hugely consumed power.

2.3 Types of Sensors

Sensors are the medium that communicates the physical world with a conceptual world (processing unit). It is the most important part of the network. It detects several types of physical state of the environment. The sensors can be classified according to type of transferring signals [2].

Sensors used optical radiation

These types of sensors depend on optic as a signal to transfer the data that sensed.

Sensors used radiation

This type of sensors generates electromagnetic signals to transfer the objective, it works depending on the measuring the reflected wave.

Sensors used light or leaser

It works depending on modulation the incoming light or laser then modulate it, an array of pixel competent of sensing the phase of the incoming light according to time, distance, α , between sensor and light.

Mechanical sensors

There are set of mechanical sensors such as pressure, gas, water meter, mass and liquid.

Thermal sensor

This type of sensor used to calculate the temperature.

Heat sensor

This type used to greed the heat of the environment or some manufacture parts.

Acoustic sensors

This type used for sensing sound microphones.

2.4 Protocol Stack for WSNs

In a wireless sensor network, the stack is like a network standard. But it has three extra levels to the seven levels of the OSI model. These three levels are (power, mobility, and task) management plane as shown in the Figure 2 [3].

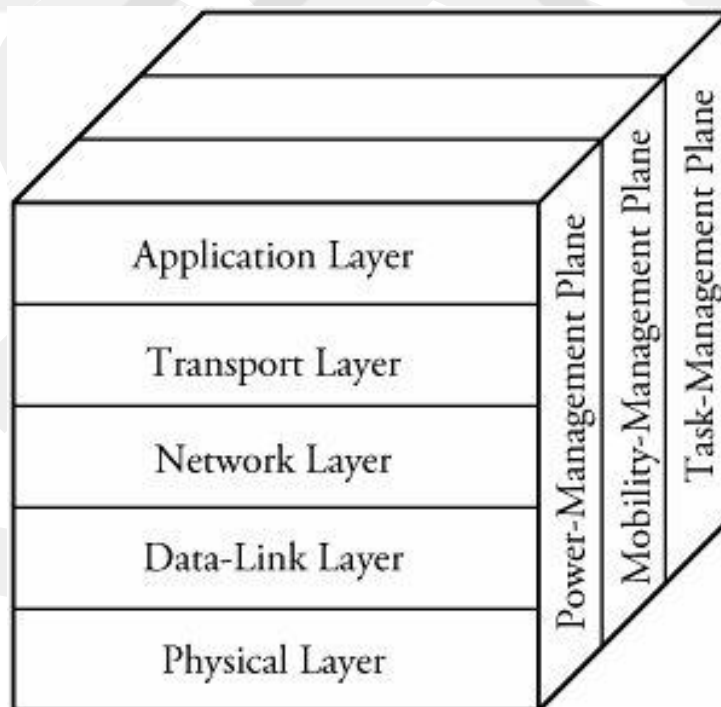

Figure 2 Wireless Sensor Network Protocol Stack

The standard layers of WSN:

1. The physical layer
2. Data link layer
3. Network layer
4. Transport layer
5. Session layer
6. Presentation layer
7. Application layer

The Extra three plans:

1. The power management plane: It is responsible for taking action depending on power exhausted of the sensor.
2. Mobility management plane: It responsible for making sure that there is a route to next node as well as movable nodes.
3. Task management plane: It is responsible for controls and processing of data.

2.5 Flowchart for Operation Sensor in the Node

The sensing operation of the sensor is not random, but depends on scientific studies and rules. After sensing any type of physical state, in the microcontroller the signal will change to the data. The computed data have to be compared with specific data which is a threshold. According to comparison, if the data bigger or equal to threshold the data will take action like a flashlight, turn alarmed, close, open etc. In WSNs the data will transfer to the base station. But if the sensed value less than the threshold so the data will cancel. As shown in the Figure 3 [4].

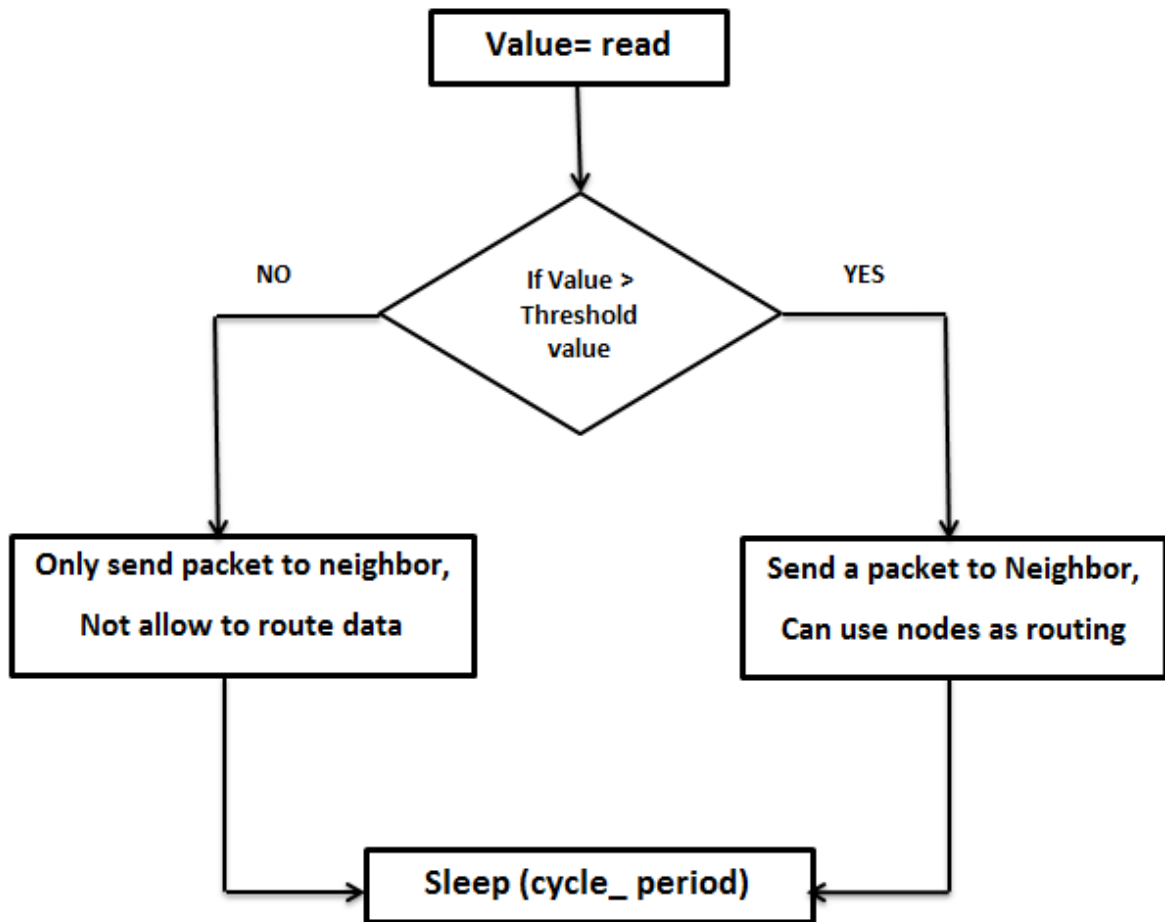

Figure 3 Flowchart of the Sensor Operations [4]

2.6 Topologies used for Data Aggregation in of WSN

In WSN several of topologies can be done for data aggregation and delivered. The topologies are Chain, Tree, as well as Star. Data Aggregation topologies used to improve many properties in the network. Such as data transfer accuracy, data collection, and data transfer. In WNS the amount of lost data is high, so collection data techniques is important to make the value of redundancy less. significant algorithms used for deploying nodes over sensing area, as shown in the Figure 4 [5].

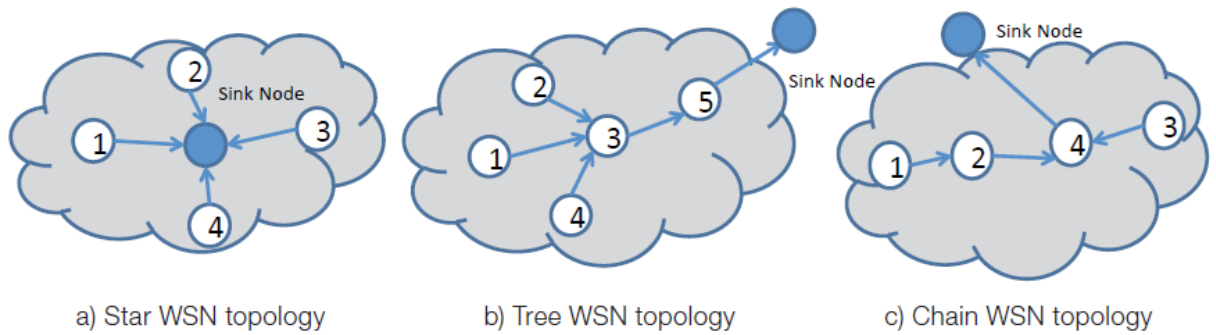
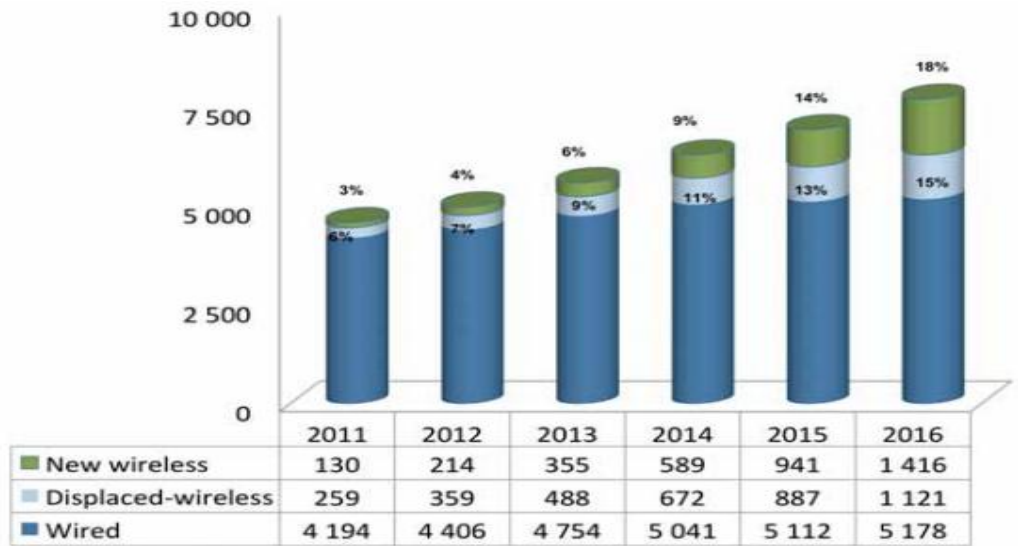

Figure 4 Wireless Sensor Network Topologies

2.7 Wireless Sensor Network Standard and Statistics

The standard 802.15.4 specified by IEEE, used for applications, managements, and protocols WSN. The wireless sensor network processes are different if we compared it with a traditional network. For instance architecture of the network, the power used, distribution of nodes, the field of work, the volume of the project, the site from that type and medium of the transmission signal [6].

According to ON World, we notice the growing in WSNs is huge quite dramatically last years, on the scope of the hardware and the network in general. Hence, the used of this technology in manufacturer in last years increased by more than 600%. The number of devices which used the technology of WSNs 25 Million devices in different fields, as shown in the Figure 5 [7].



Source: ON World

Figure 5 Global industrial field instrument shipments, wired and wireless

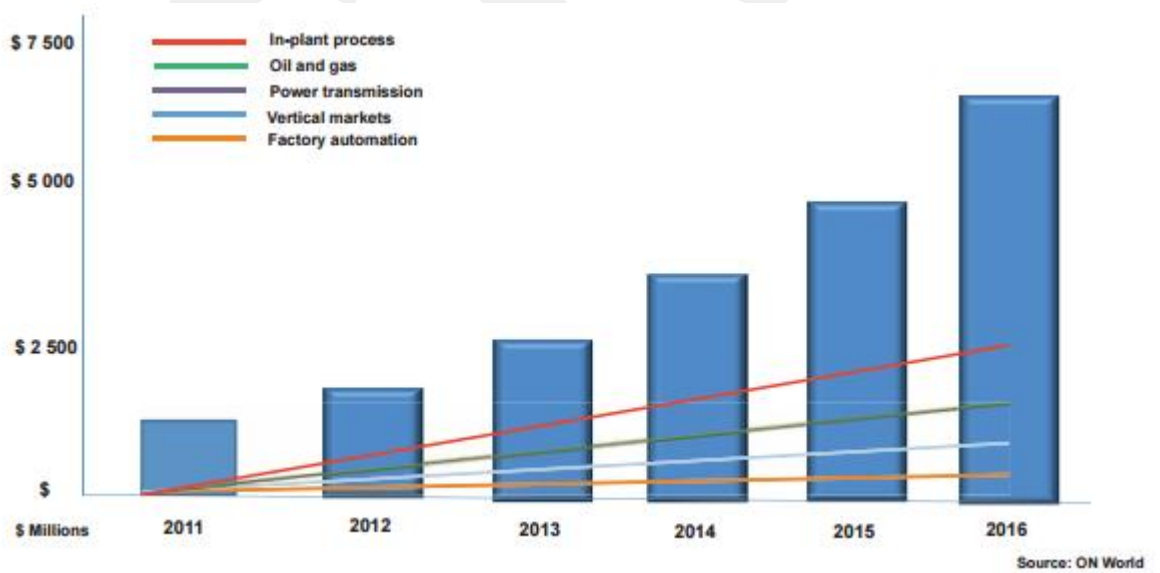

Source: ON World

Figure 6 WSN revenue growths in all industries

2.8 Application of Wireless Sensor Network

We can classify WSN applications according to its purpose, to either monitoring or tracking as shown in the Figure 7. Each of these two categories contains applications. For example, It can be used for first aid in hospitals to monitoring critical cases, in factories it use for control the products. WSNs used in military side for tracking purposes. Also, it used in daily life to tracking cars to overcome the traffic jam. [8]. Decreasing the cost of manufacturing sensor nodes help in growing using WSNs in every field as shown in the Figure 8 [9].

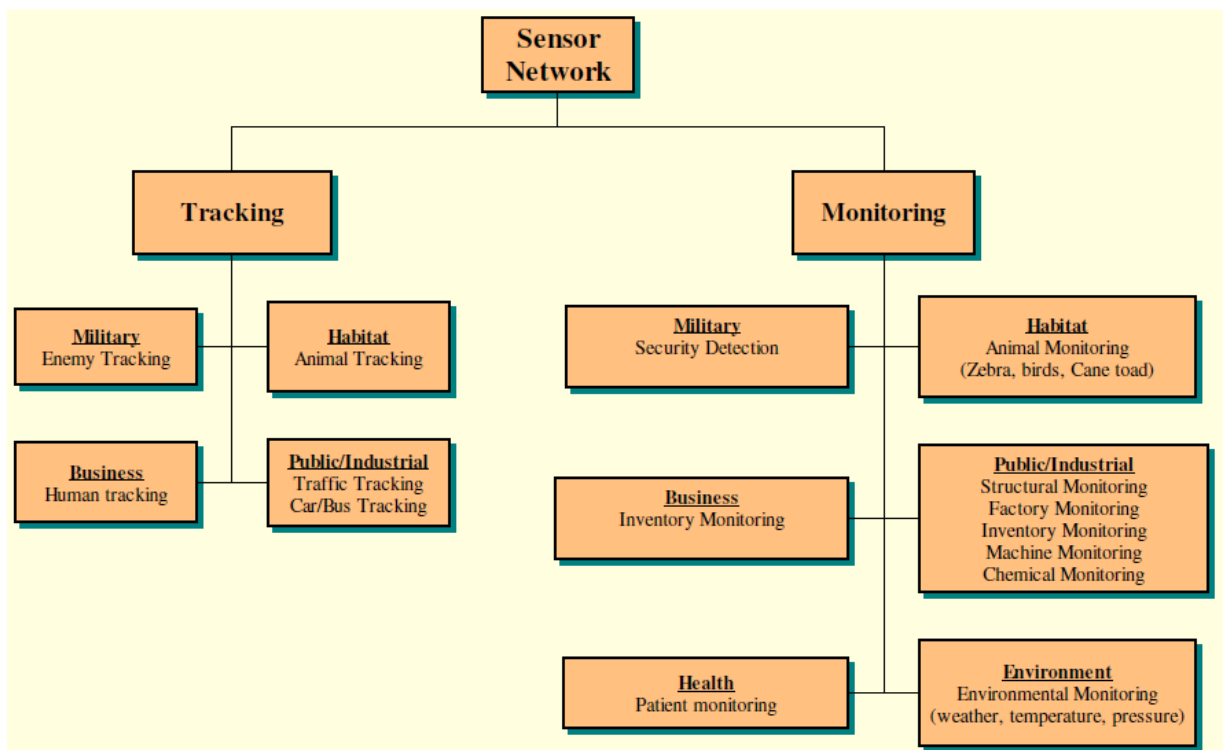

Figure 7 Applications of wireless sensor networks

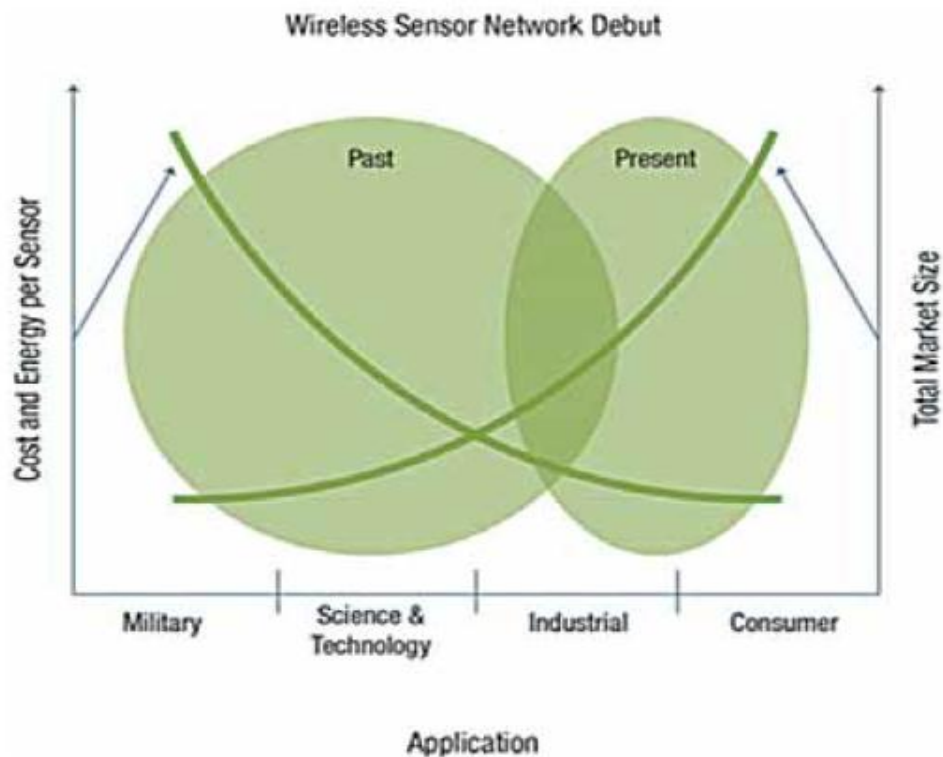

Figure 8 Market size of WSNs and the cost of manufacturing

We have an example of using wireless sensor networks in a volcanic alarm system. Where, the nodes spread on specific positions, then sends data and information related to heat and movement of the earth. The sent data from sensors collected and analyzed in the base station and according to special equations, will predict the volcanic time. As shown in Figure 9.

Another example of using wireless sensor networks in our daily life is the Bushfire Detection System. It is generally used in the forest to avoid the fire disaster. The system consists from set of nodes distributed over the forest. It is sensing the increasing in heat and sent the data to sink. After the sink receiving the data, will analysis, it is working on putting out the fires in forests. As shown in the Figure 10.

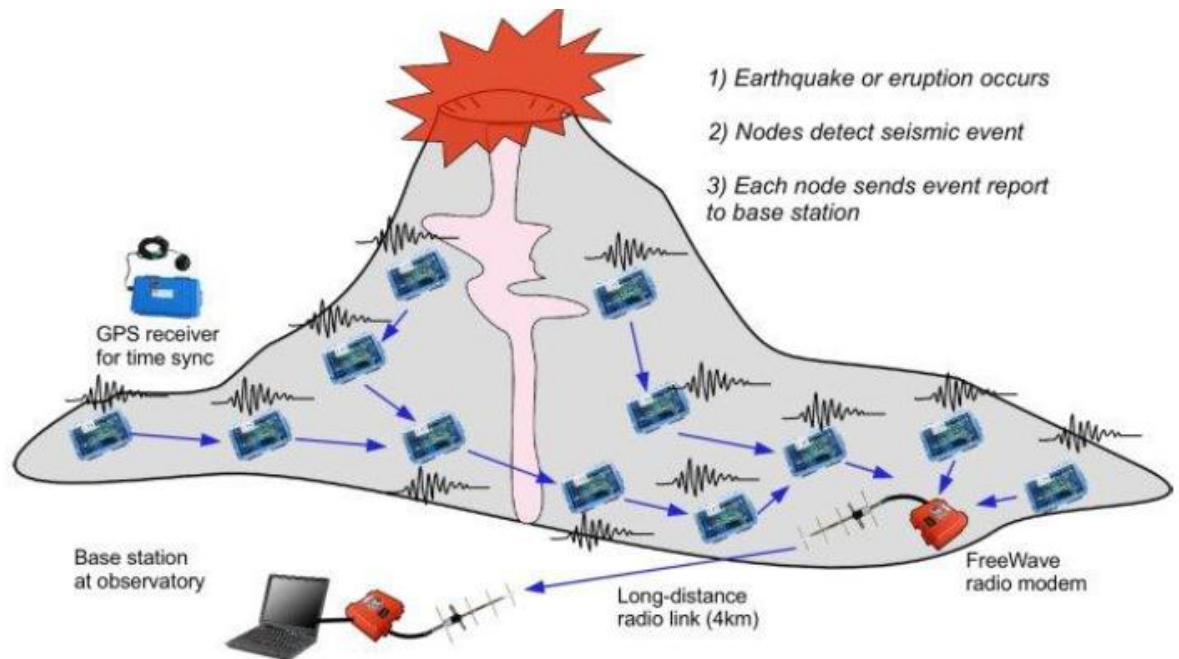

Figure 9 Implementation of WSN in Detection of Volcanic Activity [10].

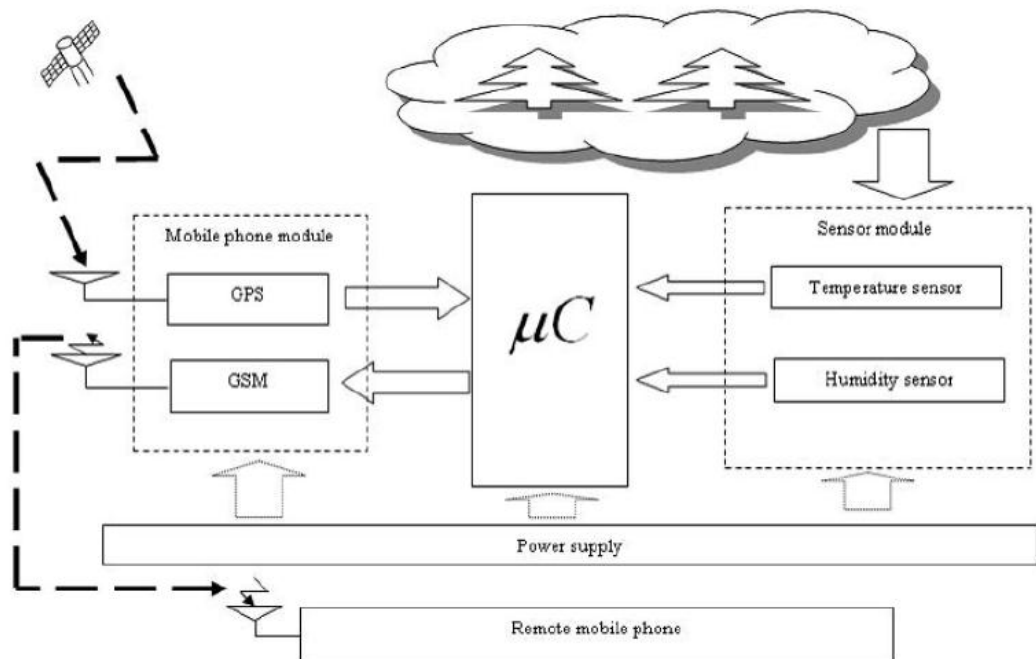

Figure 10 Using WSNs in Architecture of a Bushfire Detection System[11].

2.9 Power Consumption in WSNs

Wireless sensors are deployed densely in remote locations, and their operation is unattended. For this reason, they are equipped with battery and usually these batteries cannot be replaced. Due to the size and location the wireless sensor node. So the battery power capacity available to the unit is very important. The battery life in the nodes defines the lifetime of the network, so we have to study energy consumption in every part of our system and try to optimize it to make it less as much as possible. From here we start with the central part of the wireless network, which are the nodes.

Sensing unit is designed according to the purpose and function of this node. It may detect the temperatures, light, gas, etc. The difference in sensing reflected difference the energy consumed, as shown in Figure 11. It is worth mentioning, the consumption of energy is different from mode to mode the same node. Hence, the sensor consists of parts such as sensing, processing, and communication. The power consumption of them is not equal as shown in Figure 12. So we have to understand all of these parameters and put it in our calculation to design useful wireless sensor nodes.

Sensor Type	Power consumption
Gas sensor	500mW-800mW
Image Sensor	150mW
Pressure Sensor	10mW -15mW
Acceleration	3mW
Temperature	0.5mW- 5mW

Figure 11 Power consumption in different types of sensors[12].

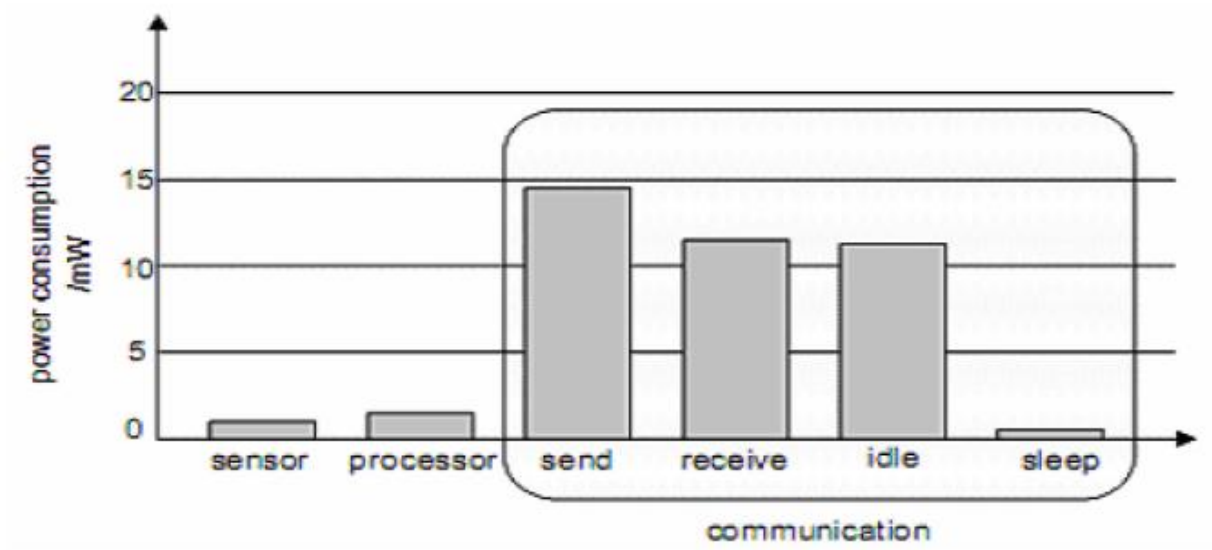

Figure 12 Power consumption, according to sensor mode [13].

CHAPTER 3

LITERATURE REVIEW

3.1 Unbalance Energy Consumption

In wireless sensor networks, the central part of the network is a sensor because they have to satisfy additional job after sensing. It is the sending of data to the base station. The data may send directly if the node is near to the base station, to vast networks most of the sensors deployed far from so base station did not reach straight by nodes. Therefore, we have to use strategies to make communication between base station and nodes in the sensing area. Therefore, in a large immobile WSN nodes are responsible for using multi-hop data transfer and many- to-one pattern, employing other sensors in sending data. The nodes transfer its data to the base station if the base station in its sensing area or relaying the data into another node which is nearest to base station, if the base station out of coverage area. Such situation, the sensors that near to the sink as a comparison with far from nodes transfer extra data, this will reflect on the amount of energy used they will consume their energies faster. This caused unbalance in energy consumption and this node will die before the other and effect negatively on network lifetime [14]. As shown in Figure 13, we will clarify this problem. To clarify the idea sensing area is divided into two regions as close to sinking and far away from the sink. The first group which closes to sink can send its data directly to sink as well as relaying the data coming from the second region. The nodes in the second region just sense and relay data to nodes close to sink. As a result, the nodes in the first region will lose extra energy for its extra job which is relaying. That led to consume more energy. If any

sensor in the first group (near to sink) has exhausted its all of his energy then it will be out of work. As a result, its sensing area will be uncovered that led to stop the network. Although nodes in Area 2 (far from the sink) still have power [15]. This uncovered area caused by dies sensors called “Energy Hole Problem” as shown in Figure 13.

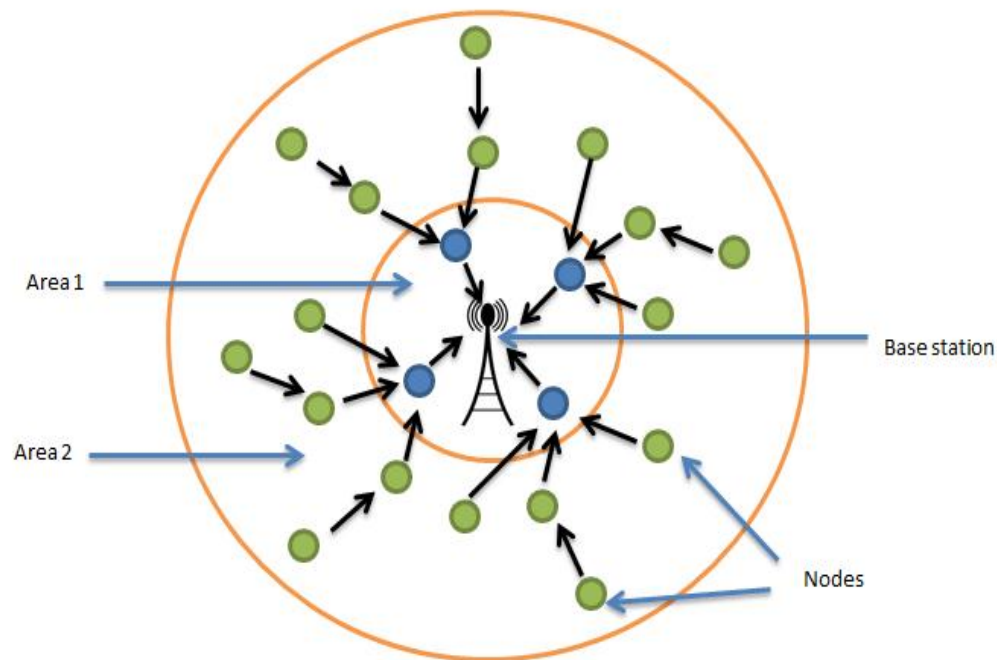

Figure 13 The problem of energy Hole [15].

3.2 Solving Unbalance Energy Consumption

The main idea behind this section is to highlight the ways have to follow it to satisfy energy balancing in WSN. At the same time to following forms to avoid the die of some nodes in a network before the others, which rise uncovering areas caused disconnecting among some nodes with the base station. Load balance in wireless sensor network managed by allocating the duty among all nodes equally. Hence, every node has to process the same amount of jobs. Thus, all nodes will consume the same amount of its energy (battery power) and die almost simultaneously. By this strategy, we will prevent any disconnection in a network and prolong the lifetime of wireless sensor network [16].

There are many studies and research about energy hole problem to analysis and find solutions this problem:

Xuejian Zhao et al. [17] the researchers review the system that has special properties which are, nodes are homogeneous uniformly designed have the same rate of processing communication storage and maximum transmit power. The nodes distributed randomly over the area. Besides, the transmit power can be adjusted and always be the minimum to reach the next hop node on the routes. Nodes detected then send the data to the single sink hope by hope. They have used the equations below to calculate the energy used in sensing, processing, receiving and for transmitting data.

$$P_{sense} = \alpha K.$$

$$P_{process} = t_a P_a + t_s P_s.$$

$$P_{receive} = P_{rb} K_r.$$

$$P_{transmit} = P_{tb}(d) K_t.$$

α represent the power consumption for single node collecting one byte; K represents data rate, P_a and P_s stand in the strength of the processor in case of active or sleeps separately. t_a represent the working period of a processor in a time unit and t_s describe the processor sleeping time. P_{rb} is the energy consumption for receiving a byte, K_r is the number of bytes received in a time unit, $P_{tb}(d)$ is the power consumption of transmitting one byte to d-distance, and K_t is the number of bytes routing in a time unit.

The researchers Stojmenovic et. al. in [18] studied the problem of energy hole theoretically. They spread the nodes uniformly.

Energy calculation equation is $E = da + c$ as an energy model. d represents the dimension between from the sources to the target node, a consuming in energy which related to c . By these presumptions, they got this result and approved: if $a > 2$ eliminate unbalanced consumptions of energy. While if $a = 2$, we cannot eliminate unbalancing in energy consumptions.

Academic researchers continued to study the problem of imbalance in power consumption. They have appeared on uncovered area (hole area) in the wireless sensor networks structure and produce theories to solve this issue. The solutions for the uneven energy consumption in five criteria: clustering nodes, movable nodes, controlling transmission power, manage data collecting, non-uniform deployment.

3.2.1 Clustering nodes

One of the most important methods used for balancing energy consumption is clustering. Nodes cluster upon its locations. Every cluster region typically involves a single cluster head (CH) and a combination of nodes. Cluster heads are responsible for gathering data from its region, then forwarding the collected data to the base station (BS) hop by hop or directly if it is near to base station [19].

A. Jain et al. in [20] present energy method named as “energy efficient clustering with sink as cluster head – EEC-SCH”. They make base station as one of the cluster-heads, by this step, the nodes near to it avoid the relaying job and save its energy. The proposed method EEC-SCH sensors spread in a specific region. When network initialized, each node v_i belong to network $N(v_i)$, r the radius

$$\text{Given by : } P(v_i) = k \times \frac{ERE}{E_{max}} + \frac{nbr(v_i)}{nch(v_i)} \quad \text{for } v_i \in Nch$$

The base station is generally particular node have more energy as a comparison with other nodes supported with an advanced microcontroller and transceiver equipment.

Base stations are designed and supported by many antennas to address simultaneous transmissions and receptions, to solve energy hole problem around it. In their simulation, they have chosen sink as one of the cluster head and the network lifetime has improved. Beside more energy balancing, as well as a lot of power consumption among cluster-heads have been provided.

Jiguo et.al. in [21] produced protocol and method in heterogeneous WSNs to solving Energy Hole Problem. The protocol is “ an energy-driven unequal clustering protocol (EDUC) “. The method is “ energy-driven adaptive cluster head rotation “. So they satisfy balance in power consumption in all clusters heads by unequal area. On the other hand, balance the power exhausted in clusters by the using method. That reduces the power consumption. Finally, that will help to prolong the network lifetime.

Vrinda Gupta and Raju Pandey in [22] improved the protocol of Energy-Aware Distributed Unequal Clustering (EDUC). Hence this protocol used in multi- hope WSNs to solving Energy Hole Problem. The remaining energy and base station location are the main parameters in the network clustering. The researchers add the third condition to the previous study in electing a cluster head. Hence, they have selected the CHs as the considered information about nodes in a neighborhood. Computation competition radius of a neighborhood and its numbers led to the extra balancing of energy in comparison with the old method. The selection of next hop, the relay metric is defined directly as well as to distance information used in the EDUC.

The
$$t = \begin{cases} \frac{E_{avg_res}}{E_r} T_2 V_r, & E_r \geq E_{avg_res} \\ T_2 V_r, & E_r < E_{avg_res} \end{cases}$$
 characteristic of EADUC

1. To solve hole’s problems they detected more than one cluster heads. It had been used to calculate the parameter Vr which used to manage the sending forward the sink depending on two factors the total energy of a node and the timeT2. So

before the time, T2 finished any node might be the head. In parallel, any node might be group head if its message not cluster heads.

2. The differences in radius used for producing uneven clusters based on the distance to the base station.
3. The relay metric is used to select an efficient route to the sink. This metric leads to save energy and extend the network lifetime.
4. The clustering overhead reduces as the cluster set up is retained for a few rounds. Therefore, the network lifetime extended.

Tung-Hung Chiang et.al. proposed a “regional energy aware clustering with isolated nodes for wireless sensor networks, called it REAC-IN ” [23]. The selection of cluster-heads is not casual but depends on particular calculation. It depends on the remaining power of all nodes and regional energy sensors in clusters. The algorithm depends on the distance between nodes and BS sometimes isolate far from nodes. Because these sensors were consuming much power whenever communicate with the sink directly. Therefore, this isolation will extend the network lifetime.

The process of proposed REAC-IN:

A. Cluster-Head Selection Algorithm Based On The Residual Energy and the Regional Average Energy:

In this algorithm, they select cluster heads according to a specific percentage of sensor nodes. The selection of cluster heads is not random, but depending on the remaining energy and regions of all groups to an extension the network lifespan. (Where p is the suggested percentage of cluster-heads) based on the residual energy and the regional average energy of all sensors in each cluster to prolong the lifetime of the network.

B. Isolated Node and Transmission:

Second step the cluster-heads which are selected by sending a “join request message” to non-clustered sensors which are close to it. The remaining node would isolate from this cluster. This action helped in conserving the energy and extend network lifespan.

3.2.2 Movable nodes

Mobility is one of the strategies and methods that used in WSNs to extend the network lifetime. To extend the network lifespan, they are supplying the system either a sink or nodes have the ability to move.

Bahmanyar and Aee mechanisms [24] present a scheme to optimize energy consumption by using mobility sink. Hence in this type of WSN, the nodes will not send the data to the base station but the Beat will move to cluster head and receive the data to minimize energy consumption. They used two-level fuzzy logic.

- The first level, the selected nodes depend on neighbors and energy
- The second level, depending on test the groups of successful nodes

In [25] Wang and et al., investigate the benefits of WSNs. It consists of a less number of moveable and more of immobile nodes. These moveable nodes may work as base station or node.

They evaluate the algorithm, their comparison the lifetime for different algorithms for three cases:

- (i) All network is static
- (ii) One mobile sink
- (iii) One mobile relay

They found that maximum improvement in a lifetime when they used mobile node as a base station. However, in some areas, the BS cannot move easily. They examine the performance of a vast network with one mobile node and notice that the improvement in network lifetime over an all static network is point 1 upper bounded by a factor four. Also, the mobile node needs to stay only within a two-hop radius of the sink. They construct a joint mobility and routing algorithm which comes close to the bound. However, this algorithm requires all the nodes in the network to be aware of the location of the mobile node. They proposed an alternative algorithm, which achieves the same performance, but requires only a limited number of nodes in the network.

P. Chana et al. [26] propose “distributed fault diagnosis algorithm for WSNs by using Mobile Sink (MS)”. However, they used a mobile robot with a wireless transceiver for mobile fault detector, which works as a mobile base station. Also it diagnose the hardware and software status of deployed network sensors. MS mobile fault detector moves through the network area polling each static sensor node to diagnose the hardware and software status of nearby sensor nodes using only single hop communication. Therefore, the fault detection and functionality of the network are significantly increased. They employ an optimal fault diagnosis tour planning algorithm to maintain an excellent Quality of Service (QoS). In addition to save energy and time, the tour planning algorithm excludes faulty sensor nodes from the next diagnosis regulating.

In [27] authors produced the protocol Dual Sink energy efficient for the Wireless Sensor. They used two types of sink to collect data from nodes mobile and a static sink. So they called it Dual-Sink. By using the mobile sink, they solved the biggest problem in WSN which nodes near to the sink exhaust their power quickly because they concern to relay the data coming from other nodes to BS. The movement of the sensor near to the BS will positively effect on energy consumption and enhance network lifetime. The movement of the base station responsible for updating and sharing its location allows nodes to send its data..On the other hand, the nodes can not achieve the

mobile BS, they can send their data to static one. Finally, they mentioned that using only one mobile sink, did not lead to improve the lifetime if the sensing area was huge.

3.2.3 Manage data collecting

The data aggregation scheme is popular topics in WSNs to optimize energy depletion as a result of these enhance the lifespan. In WSNs system, sensors are responsible for sensing actions then relaying these data to base station. Many of these data are nested information and repeated so it will have a bad effect on power. The solution to this problem is data aggregation which is responsible for filtering data abundance. Then data collection will reduce the total according to design and remaining energy to reduce power consumption, and maximizing network lifetime [28].

M.Krishna et al. [29] defined data aggregation system that the data collected by cluster head will aggregate and forward to the base station. There are many elements have to consider in the data collection protocol such as power, data size, coverage area. Then they present a novel approach depending on three factors structure, search and time-based methods to classify the protocol. Hence, they produce the classification of data gathering in WSNs as shown in Figure 14. They have taken these results and compared it with another protocol, "the structure-free, time-based or research-based data aggregation protocols" notes improving in network lifespan.

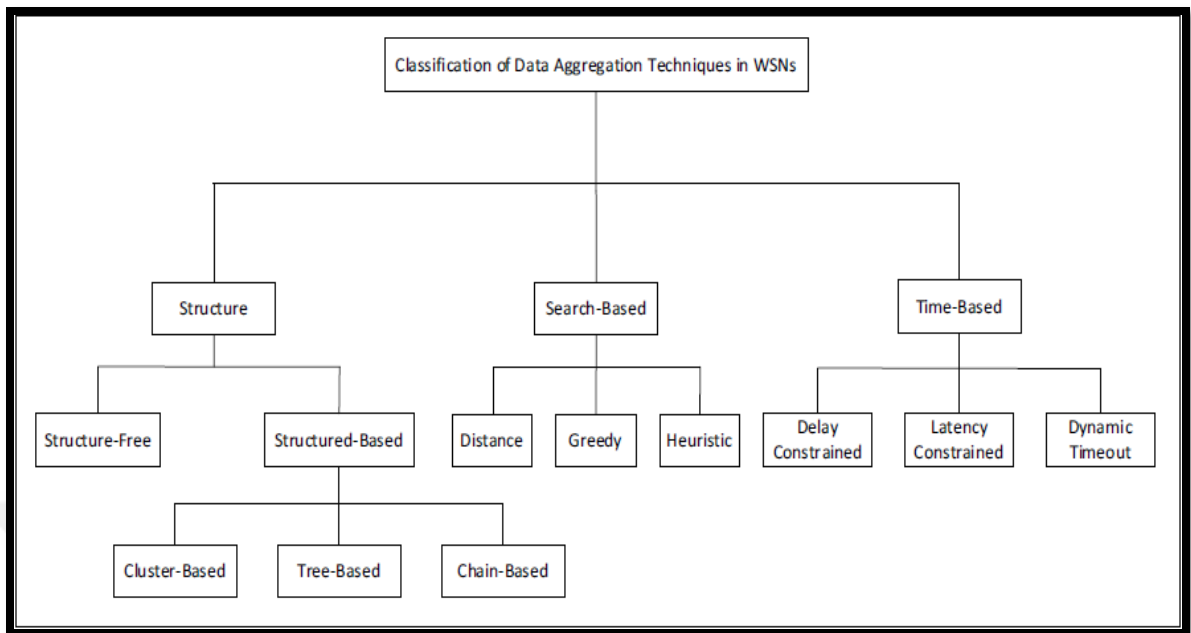

Figure 14 Data Aggregation Techniques in WSNs [29].

Awang et al. [30] propose mechanisms to solve the problem of Wireless Sensor Network that appear due to dense deployment and a lot of sensor nodes in WSNs. Where data are related to size, quantity and more detailed. Thus, the nodes commonly transmit same data while it is not acceptable in WSNs because it will consume more energy to send.

The proposed mechanisms consist of two data collection mechanisms” (class-based and alpha-based) that aggregate and route data packet based on Received Signal Strength Indicator (RSSI)”. Hence, each node maintains RSSI value on the sink. Using the "RSSI and Agg ID in RSSI-Based Forwarding (RBF) on data aggregation identification (Agg ID)" is specific. Their simulation showed that this mechanism helped in normalized power exhaust to improve lifespan.

In [31], new algorithm had been produced by researchers to solve the problem which is congestion in a network, then collision and lose a packet which normally occurs in WSN, which is appear because of centralized data aggregation and relying on communication of multi-hope strategy. That problem cause unbalancing in energy

consumption for nodes. From here, they invented an algorithm to balance loads on nodes. The algorithm is depending on the space from nodes to BS. They sort sensor nodes according to their distance to sink into a different field. They established multiple paths between nodes and BS. As a result, the algorithm balanced energy load and extended network lifetime.

In [32], data aggregation is one of the applied techniques in WSNs. It used to manage the collecting the data from nodes in a way that contribute in prolonging network lifetime. In some applications like using WSNs to measure temperature. Minimization of the total data amount are required and acceptable. The reducing in data happened in sensor, after detecting and before the sending the data to base station . For example, if we want to send pressure information, we can send just number such as, 75. This process will contribute to reduce the amount of transferred data and prolong network lifetime.

3.2.4 Non-uniform deployment

This way used for solving unbalanced power consumption problem in WSNs. Hence, sending data in many routes lead to unbalance in power consumption in a network. This uneven energy depletion reduces the useful lifespan of the sensor network. If we deployed the nodes in non-uniform deployment with carefully increasing the number of nodes around the sink, we could prevent the nodes near base station from exhausted their energy before others to avoid energy holes problem [33].

In [34], the novel model had been proposed a spread nodes non-uniformly. The main idea behind this model is reducing node numbers to enhanced encasement and load balancing. Nodes density increased from the edge to center as well as, a specific number

of nodes to overcome the unbalance in load. Hence, these nodes are responsible just for relaying data not sensing. The distribution of nodes is not reckless but, they produce a simple distributed algorithm for distribution and balance the load gathering data.

Tsai et al. [35] proposed IFA-based deployment strategy. It is a non-uniform and multi-hop routing node deployment strategy. The strategy is specified for a randomly distributed node on large-scale WSNs. In the proposed deployment strategy, three factors are taken into consideration and well examined:

- a) Area that covered
- b) Sending data
- c) Power exhausted.

The “IFA-based deployment strategy” improved the encasement performance of WSNs.

In [36] author had suggested to solve the problem of unbalancing energy consumption in WSNs by using non-uniform deployment of nodes in the working area. Handling of the problem based on three axes:

First one, the academic side of the “non-uniform node deployment strategy in multi hop heterogeneous nodes in WSNs” is presented.

Second one, expect the best sensors deployment by calculating nodes energy exhaustion propose a scheme to nonuniform node deployment.

Third one, do the comprehensive experiments to investigate the performance of a network.

They had compared the results shown that non-uniform deployment saving more energy and maximizing the network lifespan.

Cardei et al. [37] proposed solutions for one of the main problems that we focus in WSNs, which unbalancing energy was consuming in sensors that used in networks. Hence, they addressed the issue of Movement-assisted Sensor Positioning (MSP) to increase network lifetime. Address the issue of “Movement-assisted Sensor Positioning (MSP) “to maximize network lifespan this achieved by decreasing the mobility nodes.

Set of algorithms had been proposed to allocate nodes depending on density: an “IP-based mechanism that produces the optimal solution, “a localized matching algorithm” used in the huge area, and “a low-overhead distributed scanning-based mechanism”.

3.2.5 Transmission Power Control

One of the most important factor in designing WSNs is saving energy because limiting in nodes equipment like the battery is small as well as to microcontroller is limited. Therefore, transmission power had to control especially as we know that communication (transmission or reception of the packet) is the most power excused action in sensor networks.

TPC is exceedingly important used for minimizing the power used in Wireless Sensor Networks. This method manages and balances the power consumption on data sending from nodes to BS [38].

M. Meghji et al. [39] proposed a study to balance energy consumption and prolong network lifetime. They produced Telos platform parameters to Transmission Power Control (TPC) which applied on multi-hop WSNs. They offered a method to test TPC which used in multi-hop depending on testing and statistical. They have taken these results if the length from node to BS is steady, the energy exhaustion is increased if the number of hops is increased. So it is better to use multi-hope transmission power control.

D. Gao et al [40] they improved transmission power of nodes by “bound end to end delay” and produce a scheme for that. Also, they build an algorithm to improve the transmission power of the node. The lowest latency between sensor and BS has been taken by the researchers. They were increasing a minimum number of nodes whose transmission power improved.

On the other hand, to solve delay bound problem they use as less as energy. The operations packet delivery, data delivered from a node to its m-hop away node by utilizing TPC technology and nodes should check them remain energy before controlling transmission power.

We can summarize the procedure as below:

1. Define the model of the network and explain the packet delivery process.
2. Produce scheme for managing the transmission power controlling.
3. Use an algorithm to calculate the lowest latency.
4. Improving a minimal number of nodes' transmission power.

In [41] the author had performed a compression study among a set of TPC approach to take its effect on network lifespan. The study focused on two points the amount of power in battery and type of TPC. By using modified LP equations its name is "HCB model" they found the effects of energy level on TPC.

They used two groups of data to test the various TPC methods. The bandwidth requirements of the proposed transmission power assignment strategies had also been investigated. They performed numerical analysis to model, characterize the effects of various parameters and compare the relative performance of transmission power strategies.

Bandwidth is also important factor when they study and design a transmission power control strategy. After the design of strategy, they test it numerically to notice the effects on network lifespan, so they have determined that the lifetime enhanced by 20% as compared with “optimally-assigned network-level single transmission power”.

M Jamali et al [42] study the effect of Transmission Power Control on “ Ad hoc On-Demand Distance Vector (AODV) routing protocol for MWSNs”. Hence, ”respect to transmission energy consumption RSSI “ used for calculation energy consumption in low power mobile devices, but AODV used for medium power multi-hope devices.

They deduced that TPC technique effects on power consumption and level of TPC in mobile nodes. Therefore, using TPC will have a positive effect on the network lifetime in “multi-hop AODV routing protocol in MWSNs”.

CHAPTER 4

USING OPTIMIZATION IN WIRELESS SENSOR NETWORKS

4.1 Optimization It is defined as a choice of a better element from a set of available according to some standard. In the most elementary instance, solving optimization problems are automatically choose a value from series of input values which satisfy maximize or minimize according to the objective function. The expression "Optimization" is a wide term used in our daily life such as our work, our study, business, manufacturers, WSNs, in every sector.

Optimization it is found everywhere in our daily life, for instance, manufacturing, and marketing [43]. It is applied science depending on mathematical equations which used to take specific values which represent the objective either minimum or maximum [44]. In our lifetime, money, and resources are finite, limited. Thus optimization is a suitable solution to get perfect values [45].

4.2 Scope of Optimization Problems

Optimization defined as, it is a specific task solved automatically by process depending on the mathematic equation to get optimal value for this operation qualifications. Thus, it required a set of components:

- The objective function is either minimized or maximized. This used to measure quantitative performance. Objective value can be cost, time, energy, efficiency, profit.
- A predictive model is used for describing model disposal. This model transferred to set of equations, constants and constraints comprise defined system borders.

- Variables in the predictive model should satisfy the constraints if it does not satisfy we adjust it. In many of engineering applications [46].

Using optimization in the economics field

- Profit
- Utility
- Frugal activity
- Pareto problems

Using optimization in the Information Technology sector

- Increasing the efficiency of software
- Reduce using of resources
- Improving the compiler effectively
- Raise the website ranking in search engine list
- Improve the rank of the image in search engine list.

4.3 Maximization and Minimization of the Values

Maximizing value may represent:

- Maximization in the lifetime in WSNs
- Entropy maximization
- Maximizing Profit
- Statistics maximization algorithm
- Threshold value maximization
- Maximization psychology
- Optimization (mathematics) Activity maximization

- Utility maximization problem
- Gain maximizing model
- Magnification

Minimizing value may represent:

- Minimization (clinical trials)
- Minimization size of code
- Cost-minimization
- Energy is consumed
- Minimizing execution time
- Structural risk minimization
- Minimizing loops in programs
- Expenditure minimization problem, in microeconomics
- Waste Minimization
- Harm reduction
- Maxima and minima, in mathematical analysis
- Minimax approximation algorithm

4.4 Classification of Optimization Problems

The optimization is used in decision making. It developed by the scientist who concerns by technology depending on the mathematical methodology to help researchers and designer to take specific values encourage him in the design of the systems in the different field. Optimization algorithms are used to:

- Empirical, expansion of design, analysis and rating variables.
- Operation and system modify.
- Control the sample predictive.

- Designed, timetable, and organized the equipping set of properties according to specific orders and delivering [46].

4.5 Linear Programming

Linear programming produced in 1950 considered the most simple way to solve optimization problems used in Industrial, manufacturing, marketing, engineering calculations. It is depending on linear equations and used specific software to solve the equations. Mostly Linear Programming used for its ability to execute in most software. Linear Programs applied at first to solve simple systems such as seals man to build a road for minimizing road to achieve many cities on different distance. Later, they applied for other problems such as distributed of the nodes or manage energy consumption in WSNs[47].

4.6 Planning Process for Optimization Problems

1. Recognizing the problem.
2. Defining the problem.
3. Constructing a model for the problem.
4. Solving the model.
5. Validating the obtained solutions.
6. Implementing one solution [48]

4.7 Optimization Process

Generally, the optimization consists of three parts:

- 1- Modeling
- 2- Optimizer/Algorithm
- 3- Evaluator/Simulator.

The issue will transfer to mathematical equations to build the model. We have to use arbitrator optimizer or algorithm to solve our problem to get the excellent result. For every model we can design an algorithm, there is no unique algorithm for all cases.

Finally, evaluators or simulators can be a direct calculation for output or numerical simulator. As indicated in Figure 15.

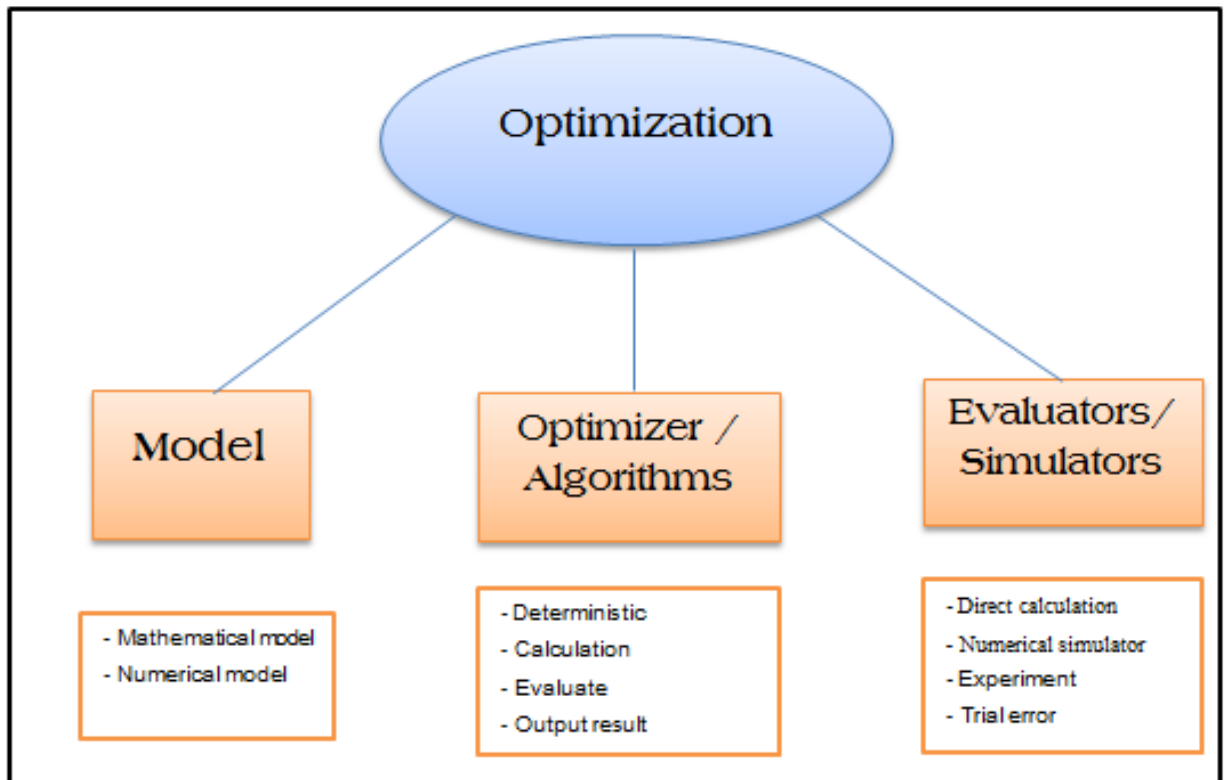

Figure 15 Optimization process[49]

4.8 Optimization in Wireless Sensor Networks

An Optimization is the selection of the value from a series of input values according to some conditions. It has solved by the optimizer to take either maximum or minimum value according to the objective function that suitable to the work. They can be used for many purposes such as, distributed nodes, selected routes, energy consumption, and data flow in Wireless Sensors Networks. According to every case, the objective value will be different. For example, for energy consumption, we have an objective value to make it

as less as possible. But in network lifetime, we have to make the objective value as long as possible. Therefore, optimization consists of two parts; the objective function and conditions. The solution divided into two factors: exact methods and heuristic methods.

1- Exact methods

To solve objective problems in Wireless Sensor Networks such as Linear, Nonlinear and Dynamic Programming, if the objective value is a single one so we have to use LP. Otherwise, if the objective value has more than one values, then the nonlinear function can be used. Because the problem is nonlinear.

Linear programming (LP) form is as follows:

$$\begin{aligned} \max \quad & cx \\ \text{Ax} \leq & b \\ x \geq & 0 \end{aligned}$$

Where cx is the objective function, we receive to maximize it. A is a matrix, b is a vector giving respectively the right-hand terms and the cost coefficients, and x is the decision variable vector.

2- Heuristic methods

Heuristic methods are important methods for the practical optimization problems in WSNs exhibiting high computational complexity. These approaches are intended to quickly provide near-optimal solutions to difficult optimization problems that cannot be solved exactly. Heuristic methods include local improvement methods that do searches within the vicinity of a viable resolution to the problem, and improve/construct the answer step by step by hiring the best local optimal decision at each stride [50].

4.9 Optimization domain in Wireless Sensor Networks

Optimization in WSNs used widely to reach the optimum value of the objective function. The optimization may be maximization or minimization depending on the purpose of the program such as for network lifetime, efficiency, connectivity, has to maximize the values. But for the cost, a number of nodes, process time has to minimize the values. The optimization depending on the set of mathematic equation selected according to the job such as a linear equation, nonlinear equation, mix integer, etc. Optimization on Wireless Sensor Networks can be classified according to problem domains and area as shown in the Figure 16 [51].

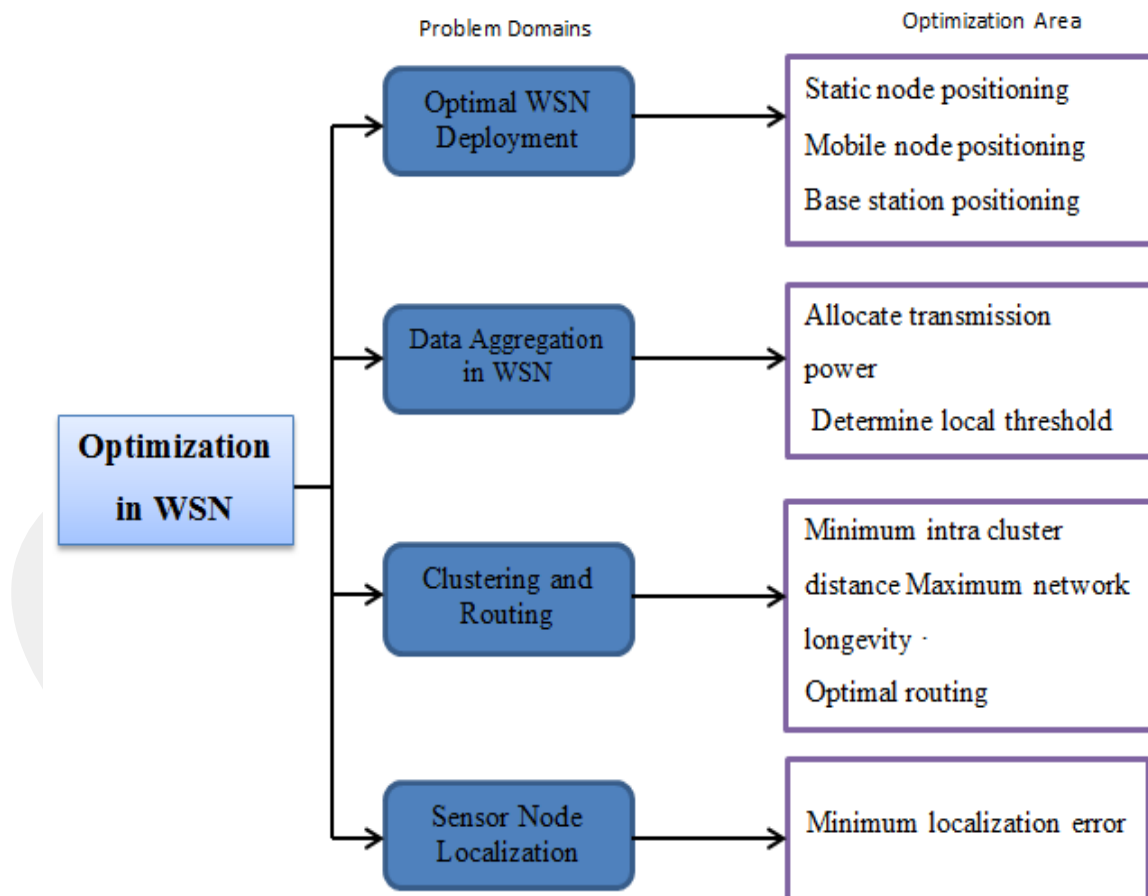

Figure 16 Optimization domains in WSNs

4.10 Simulation Tools Used To Optimize WSNs

There are many simulation tools and programming languages used in WSNs to optimize values such as NS2, MATLAB, MiXiM, VisualSense of Ptolemy II, JSim, PAWiS, GlomoSim, OPNET, TOSSIM, OMNeT++, CPLEX, C/C++, and ANSYS [52].

4.11 GAMS

The English abbreviation of “General Algebraic Modeling System” is a programming language that provides a flexible framework for formulating and solving linear, nonlinear and mixed-integer optimization problems. The GAMS technology is designed to facilitate the work of modelers, who create mathematical models of real processes around us. It relieves modelers of the necessity to design algorithms of models, in addition to the development of models. Thus, the major functional objective of GAMS is to design algorithms for mathematical models.

It does not mean that this system can be used only for mathematical models with algebraic equations. Those, who are acquainted with methods of solving differential equations in partial derivatives, know that the methods are always transformed into a system of algebraic equations. These algebraic equations are solved according to some iteration algorithm [53].

4.12 Structure Models of the GAMS

Each model in the GAMS language may have its own distinctions. It can comprise groups of alternating models, which are linked together only through a small number of common variables or parameters. However, most models have the following structure [54]:

SETS

Structures consisting of a complex of indices or names

Declaration of fact of existence

Determination of relations between individual structures

DATA

PARAMETERS, TABLES, SCALARS (parameters, tables, scalars)

Declaration of fact of existence

Determination of values of input parameters

Preliminary computations

VARIABLES

Variables or arrays of variables

A declaration with assigning a type of variable

Declaration of limits for possible changes, initial level

EQUATIONS

Equations or complexes and arrays of equations

A declaration with assigning a name

Recording of equations on the GAMS technology

MODEL, SOLVERS

The objective is to optimize the structure model and method of solution.

OUTPUT

It is output of information into a separate special file, although it is not necessary.

GAMS operates on an input file in two stages:

- a) Compilation.
- b) Execution

CHAPTER 5

SYSTEM MODEL

5.1 Introduction

Our studies in this thesis are based on optimization theory represented by a set of Linear Programming equations to minimize energy consumption which leads to maximize WSNs lifetime as much as possible. Moreover, the balance in energy consumption has been satisfied by using special deployment strategy to avoid the Hole problem that occurs in WSNs to guarantee balance in data flow among sensor nodes. Therefore, all sensor nodes in WSNs exhaust their energy approximately in equal time and the network still works as more as possible. In this chapter, the network model and basic assumption besides optimization problem formulation have been identified.

5.2 Network Assumptions

We perform the following assumptions in our frameworks:

1. We supposed that there are one base station and N sensor nodes deployed over a sensing area.
2. Nodes are homogeneous (every sensor has an equal transmission range t_r) excepted base station has an extra transmission range.
3. Our WSN consists of static nodes (both sensor nodes and the base station).
4. We represented network topology by a directed graph, $(G= V, A)$ where V is a set that contains all nodes and base station and W is all nodes set excepting sink.
5. All nodes have the same initial energy it is one joule.

5.3 Node Deployment Model

Deploying sensor nodes considered the main challenge in the network field for three reasons. Firstly, it will cover sensing area. Secondly, it will ensure the longest lifetime. Thirdly, it will contribute to continuous sensing. Based on application requirements, the different sensor node deployment models have been established. In our study, randomly deploy uniform sensor nodes are used. Consequently, the nodes will deploy randomly over sensing area, as shown in the Fig 17. Therefore, sensor nodes are deployed in places that do not ease to reach. The nodes deployment model can achieve by throwing sensor nodes from an airplane. Mostly, several wireless sensor network applications choose a random sensor node distribution, because it is supposed to be easy and cost-effective. Random distribute of sensor nodes is a most common deployment strategy used for deployment big scale open zones.

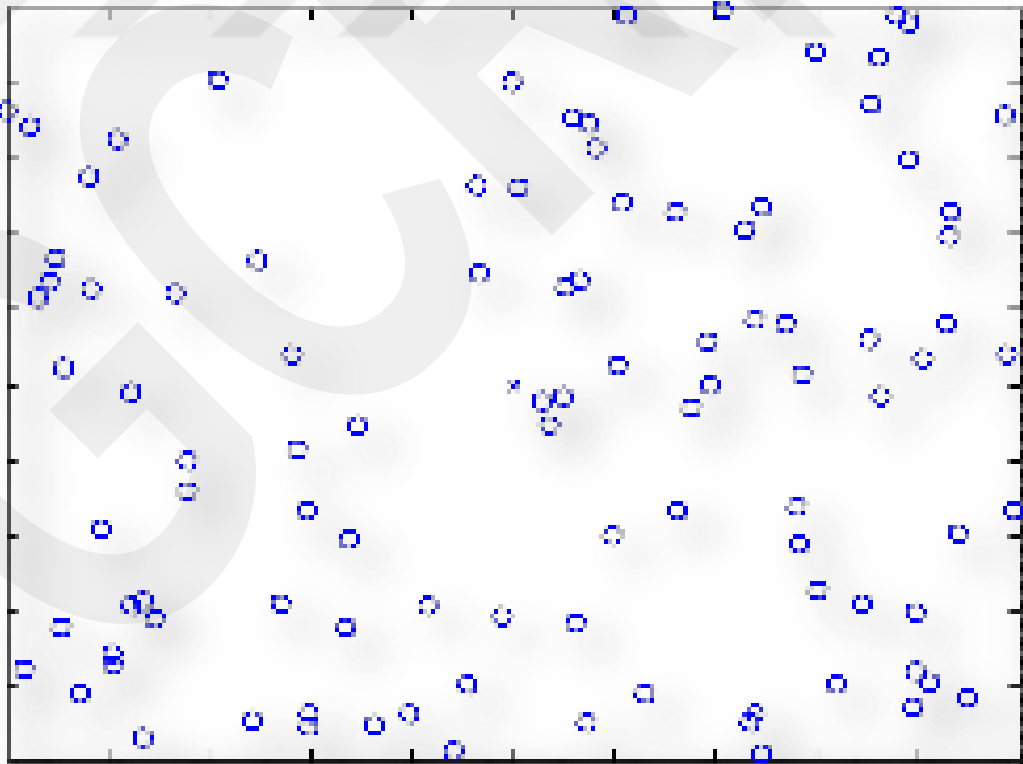

Figure 17 Random deployments of wireless sensor nodes.

5.4 Energy Model

In our model, we use homogeneous nodes (all nodes have the same properties) including the amount of initial energy. They were supplying by 1 Joule. The consumed energy calculated by the equations below:

For transmitting data is:

$$P_{tx,ij} = \rho + \varepsilon d_{ij}^{\alpha} \quad (5.1)$$

For receiving data is:

$$P_{rx} = \rho \quad (5.2)$$

Where ρ represents the energy dissipated in the electronic circuitry, ε denotes the transmitter efficiency, α represents the path loss, and d_{ij} is the distance between node- i (transmitting node) and node- j (receiving node) [55].

5.5 Network Lifetime

The lifetime of the network often depends on the nodes with minimum residual energy in the network.

There are a lot of definitions used to identify the lifetime in the term of wireless sensor networks such as:

1. Time until the first sensor node or group of sensor nodes in the network runs out of energy.
2. The operational time of the network during which it is able to perform the dedicated task(s).
3. This is defined as the maximum duration of time during which deployed sensors have the capability of monitoring the phenomena of interest.
4. The number of rounds of the network until the defeat of one or more sensor nodes.
5. This definition that widely used to describe the network lifetime is intended to reflect the time span from the network's initial deployment to the first loss of

coverage. Therefore, it can be defined as the ‘time until the first node dies’. In our study, this definition can be considered.

5.6 Model’s Equations

5.6.1 Normal Equations

We have taken the location of each node in the circle area, depending on x axis and y axis by using Eq. (5.5) for finding x axis, and Eq. (5.6) for finding y axis,

$$\text{point_x}(i)=r*\cos(\text{theta}) \quad (5.3)$$

$$\text{point_y}(i)=r*\sin(\text{theta}) \quad (5.4)$$

To find the distance between two nodes, the equation below is used

$$d(i,j)=\text{sqrt}(\text{power}(\text{point_x}(i)-\text{point_x}(j),2) + \text{power}(\text{point_y}(i)-\text{point_y}(j),2)) \quad (5.5)$$

The equation at the below is used to generate random numbers which used in equations later

$$\text{execseed} = 1+\text{gmillise}(j\text{now}) \quad (5.6)$$

The equations at the below are used in a loop together to distribute the nodes randomly over the circle sensing area. First one can be used to detect the angel, the second can be used to find the radius.

$$\text{theta}=\text{uniform}(0,360) \quad (5.7)$$

$$r=\text{sqrt}(\text{uniform}(0,\text{Rad})) \quad (5.8)$$

This equation is used to calculate the power

$$P_{tx}(i,j) = (r_0 + (E * \text{power}(d(i,j),\alpha))) \quad (5.9)$$

5.6.2 Linear Programming Equations

Our objective of the model, maximize network lifetime, which represent by Eq. (5.10), hence, t represent the network lifetime. To solve the objective equation, we used GAMS expression (5.11)

$$\text{maximize } t \quad (5.10)$$

$$z = e = t$$

$$\text{Solve sensor using lp maximizing } z \quad (5.11)$$

The equation below is used to state all data flow not negative

$$f_{ij} \geq 0 \quad \forall (i, j) \in A \quad (5.12)$$

The equation below is used to eliminate infinite loops; there cannot be a flow from a node

$$f_{ij} = 0 \quad \text{if } i = j \quad \forall (i, j) \in A \quad (5.13)$$

The equation below is used to balance the data flow between relay data and aggregation data in the same node

$$\sum_{j \in V} f_{ij} - t s_i = \sum_{j \in W} f_{ji} \quad \forall i \in W \quad (5.14)$$

Used to states energy dissipation for data communication is bounded by the energy stored in batteries (e_i)

$$P_{rx} \sum_{j \in W} f_{ji} + \sum_{j \in V} P_{tx,ij} f_{ij} \leq e_i \quad \forall i \in W \quad (5.15)$$

This equation is used to assign equal battery energy to all sensor nodes.

$$e_i = \xi \quad \forall i \in W \quad (5.16)$$

5.7 Simulation and Results

In the present study, we use a Linear Programming method to optimize the energy consumption in wireless sensor networks. The linear programming equations have been applied on two different topologies. They are linear topology and circle topology.

A- Linear topology nodes distribution (1 dimension)

We use 5 sensor nodes deployed in a linear topology $N1, N2, N3, N4, N5$. The sink node is $N1$. The distance between nodes is kept constant ($d = 10\text{m}$) and every node supported by same initial energy of 1 Joule, as shown in Fig.18.

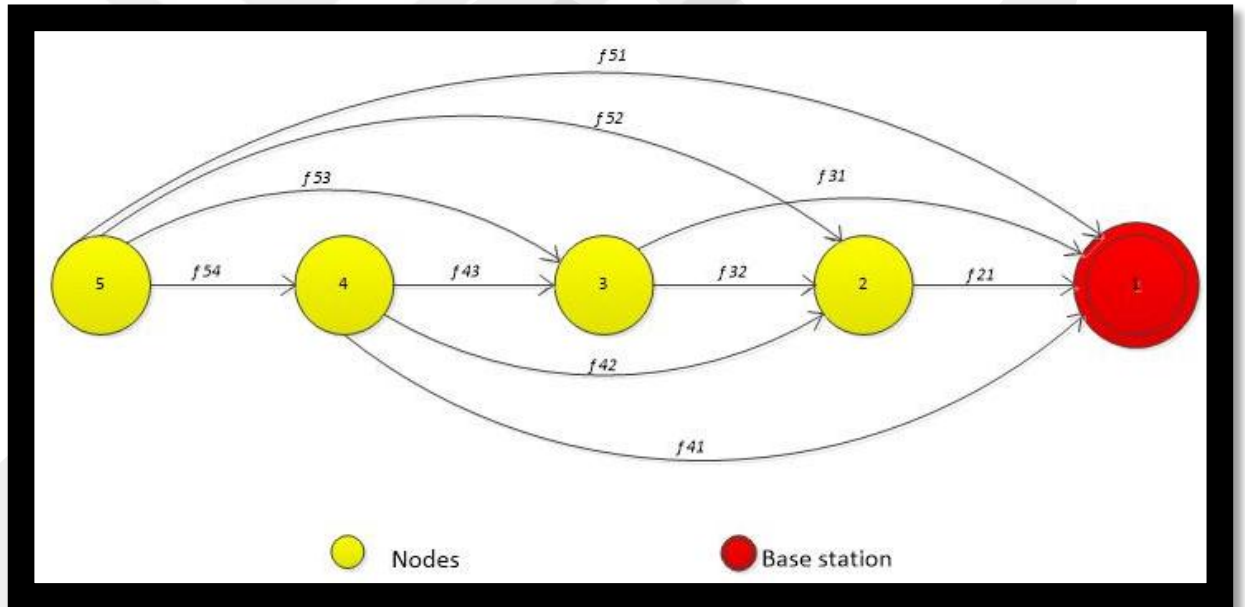

Figure 18 Distribute nodes over linear topology

Firstly, the effect of distance (from node N to Base station) on the Network lifetime have been studied. The maximum lifetime for every case has been obtained by using Linear Programming equations. The result shows that the network lifetime decreased by increasing the distance of the sensing area as shown in the Table 1.

Table1 The effect of distance on network lifetime in linear topology

No	Distance in Meter	Network Lifetime in Seconds
1	D=10	2697459.85
2	D=20	192532.96
3	D=30	88248.18
4	D=40	56690.30
5	D=50	40880.08

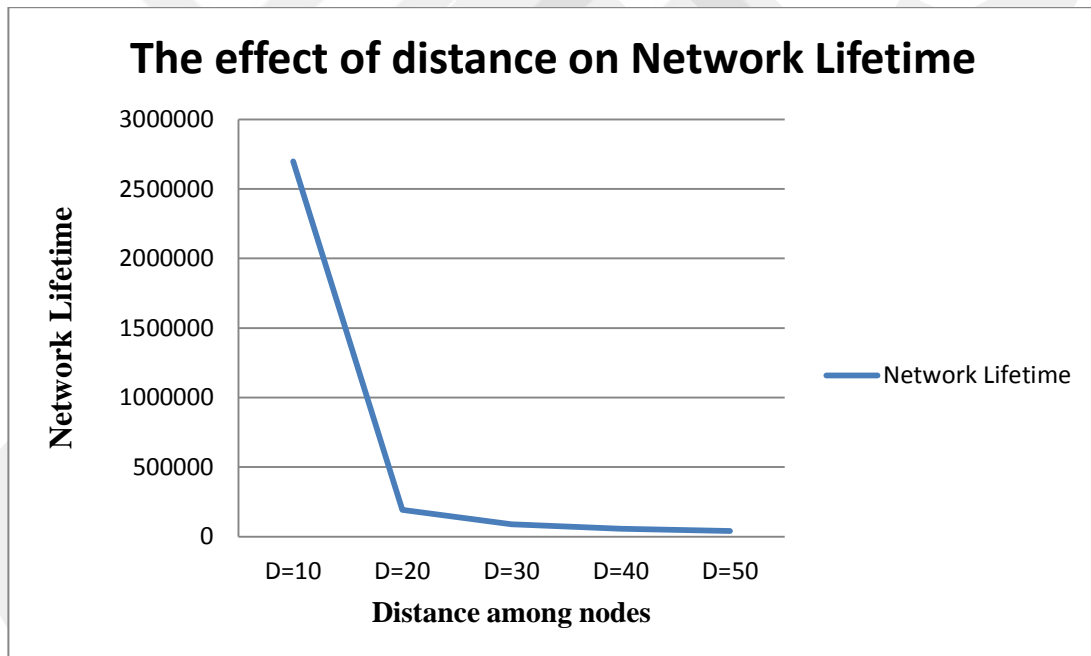

Figure 19 The effect of distance on network lifetime in linear topology

Secondly, the data flows between nodes in hand has been studied. In other hand, the data flows between nodes and base station and its effects on the network lifetime in every case have been studied. The results have been obtained and shown in the Table 2 and Figure 20.

Table 2 The effect of data flow on network lifetime in linear topology

Data Flow		Network Lifetime				
		z(d= 10)= 9845822.88	z(d= 20)= 5437858.23	z(d= 30)= 2903869.82	z(d= 40)= 1789981.96	z(d= 50)= 1225427.78
n1	n1	0.000	0.000	0.000	0.000	0.000
n1	n2	0.000	0.000	0.000	0.000	0.000
n1	n3	0.000	0.000	0.000	0.000	0.000
n1	n4	0.000	0.000	0.000	0.000	0.000
n1	n5	0.000	0.000	0.000	0.000	0.000
n2	n1	9990009.990	9090909.091	7142857.143	5263157.895	3846153.846
n2	n2	0.000	0.000	0.000	0.000	0.000
n2	n3	0.000	0.000	0.000	0.000	0.000
n2	n4	0.000	0.000	0.000	0.000	0.000
n2	n5	0.000	0.000	0.000	0.000	0.000
n3	n1	9960159.363	7142857.143	3846153.846	1637260.980	430555.707
n3	n2	0.000	0.000	0.000	1299262.889	2620726.064
n3	n3	0.000	0.000	0.000	0.000	0.000
n3	n4	0.000	0.000	0.000	0.000	0.000
n3	n5	0.000	0.000	0.000	0.000	0.000
n4	n1	9910802.775	4773996.953	626468.285	0.000	341089.586
n4	n2	0.000	663861.278	2737786.880	2173913.043	0.000
n4	n3	0.000	0.000	0.000	0.000	1825853.988
n4	n4	0.000	0.000	0.000	0.000	0.000
n4	n5	0.000	0.000	0.000	0.000	0.000
n5	n1	9522319.392	743669.738	0.000	259508.972	283911.990
n5	n2	144187.110	2989189.581	1501200.444	0.000	0.000
n5	n3	114336.483	1704998.912	942284.028	1146541.908	0.000
n5	n4	64979.895	0.000	460385.347	383931.082	941515.792
n5	n5	0.000	0.000	0.000	0.000	0.000

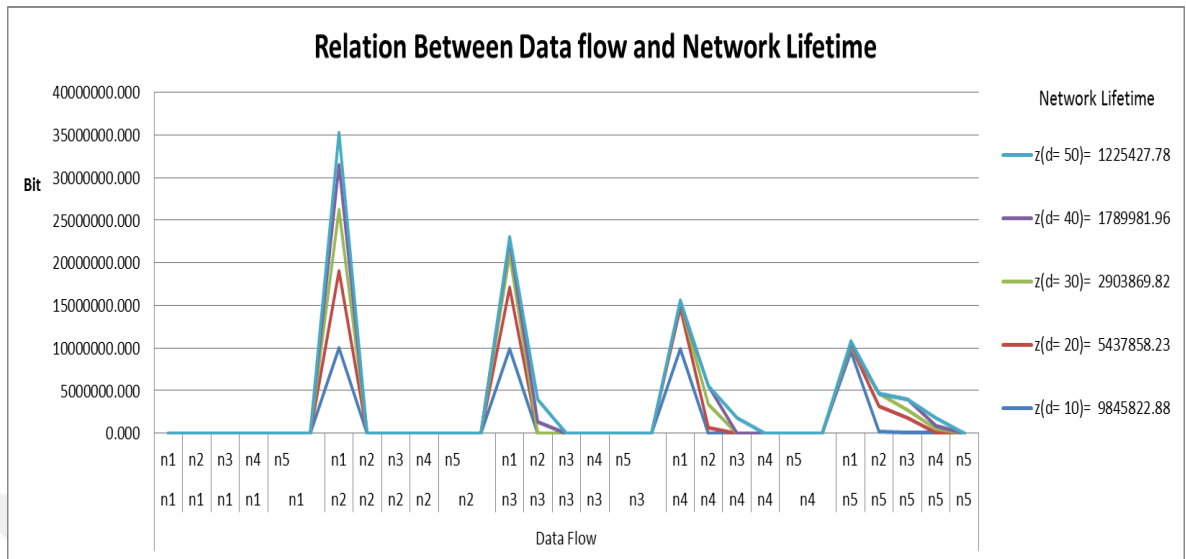

Figure 20 The effect of data flow on the network lifetime in linear topology

B- Circular topology nodes distribution (2 dimensions)

A set of 100 sensor nodes has been deployed over a grid topology (Circular area) as shown in the Fig 21. Nodes are homogenous and every node supported by same initial energy of 1J. We deployed it randomly on a circle area, depending on the special equation to generate random numbers also used a set of linear Programming equations The result has been obtained as shown in the Fig 22 and Table3.

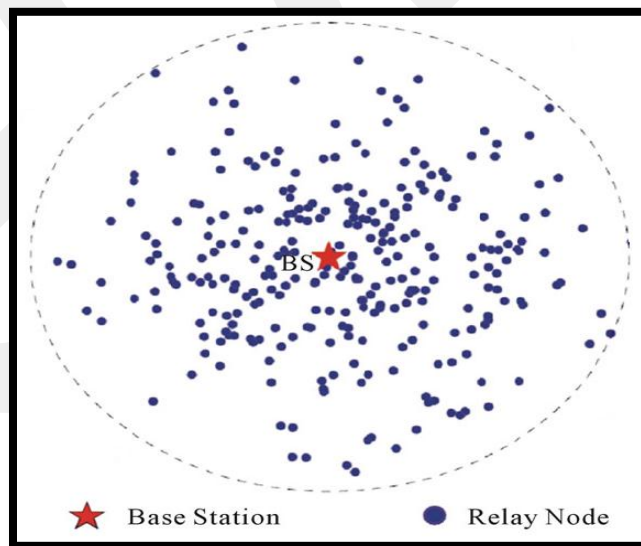

Figure 21 Distribute nodes randomly over a circular area

Table 3 The effect of Radius on network lifetime in circle topology

Radius in Meter	Network Lifetime in Second
Radius= 100	9009615.75
Radius= 200	7580868.24
Radius= 400	6072910.75
Radius= 800	5884845.16
Radius= 1600	4004580.58
Radius= 3200	2946298.65
Radius= 6400	1900605.33
Radius= 12800	1365054.2

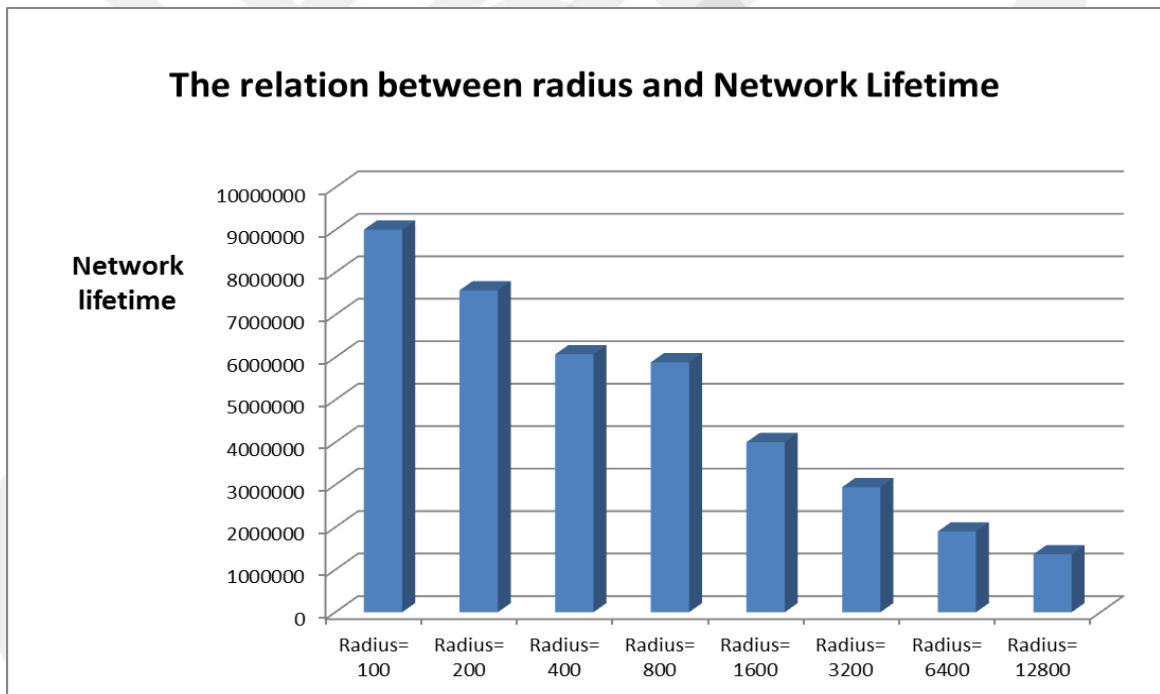

Figure 22 The effect of Radius on network lifetime in circular area

CHAPTER 6

CONCLUSION

In this thesis, the lifetime of a sensor network for random distribution of nodes with one base station located in the center of the sensing area has been investigated. A mathematical programming (LP) and set of equations to maximize the network model have been applied. This approach gives us the chance to obtain numerical analysis covering a wide range of parameters. Two topologies linear and circular topology have been applied to the network. The first topology studied the relation between distances, data flow and its effect on network lifetime have been investigated. Second, studied the relation between the radius of sensing area, a number of nodes and its effects on network lifetime have been investigated. Since the contributions of our thesis are provided in the form of a series of questions, we present our conclusions in reply to these questions. Firstly, we can ensure balancing energy consumption. Secondly, we concluded that increasing the node density (increasing number of nodes) in network field. We can increase the lifetime of the network to some extent. Moreover, the assumed distribution topology has a great impact on energy utilization. Thirdly, our simulation results have shown that random deployment network topology has great importance for prolonging the network lifetime.

REFERENCES

1. **Farooq M. O., Kunz T., (2011)**, “*Operating systems for wireless sensor networks: a survey.*,” *Sensors (Basel).*, vol. 11, no. 6, pp. 5900–30.
2. **Figuroa J. F., Everett H. R. B., Ipson S. S., Liu C.,(2009)**, “*Sensors and Actuators 16,*” *Sensors And Actuators*”.
3. **Pantazis N., Vergados D., (2007)** “*A survey on power control issues in wireless sensor networks,*” *IEEE Commun. Surv. Tutorials*, vol. 9, no. 4, pp. 86–107.
4. **Xu M. X. M., Ma L. M. L., Xia F. X. F., Yuan T. Y. T., Qian J. Q. J., Shao M. S. M., (2010)**, “*Design and Implementation of a Wireless Sensor Network for Smart Homes,*” *Ubiquitous Intell. & Comput. 7th Int. Conf. Auton. & Trust. Comput. (UIC/ATC),7th Int. Conf.*, vol. 2, no. 2, pp. 1–5.
5. **Pan M. S., Tseng Y. C., (2007)**, “*ZigBee Wireless Sensor Networks and Their Applications,*” *Sens. Networks Config. Fundam. Stand. Platforms, Appl.*, pp. 349–368.
6. **Amin Y. M., Abdel-hamid A. T., Member S., (2016)**, “*Layer Attacks,*”.
7. **International Electrotechnical Commission, (2014)**, “*Internet of Things: Wireless Sensor Networks,*” White Pap.

8. **Yick J., Mukherjee B., Ghosal D., (2008)**, “*Wireless sensor network survey*,” *Comput. Networks*, vol. 52, no. 12, pp. 2292–2330.
9. **D. S. Y., (2012)**, “*Figure courtesy of Silicon Labs and RTC Magazi*”, Fig. Court. Silicon Labs RTC Mag.
10. **Werner-Allen G., Lorincz K., Welsh M., Marcillo O., Johnson J., Ruiz M., Lees J., (2006)**, “*Deploying a wireless sensor network on an active volcano*”, *IEEE Internet Comput.*, vol. 10, no. 2, pp. 18–25.
11. **Liu A., Rong Sun A., Ying Sun A., Said Al-Sarawi, (2010)**, “*A smart bushfire monitoring and detection system using GSM technology*”, *Int. J. Comput. Aided Eng. Technol.*
12. **Bharghavan V., Demers A., Shenker S., Zhang L., (1994)**, “*MACAW: a media access protocol for wireless LAN’s*”, in *ACM SIGCOMM Computer Communication Review*, vol. 24, no. 4, pp. 212–225.
13. **Lv X., Li J., Shi T., Jia X., (2016)**, “*Topology analysis based on linear wireless sensor networks in the monitoring of high-speed railways*”, *Proc. 28th Chinese Control Dec. Conf. CCDC 2016*, no. I, pp. 1797–1802.
14. **A. K. MIR, M. ZUBAIR, and I. M. QURESHI, (2016)**, “*Lifetime maximization of wireless sensor networks using particle swarm optimization*,” *Turkish J. Electr. Eng. Comput. Sci.*, vol. 24, pp. 160–170.
15. **Liu J., Niu X., Cui X., Sun Y., (2014)**, “*GreenOCR: An energy-efficient optimal clustering routing protocol*”, *Comput. J.*, vol. 58, no. 6, pp. 1344–1359.

16. **Chanak P., Banerjee I., Rahaman H., (2014)**, “*Load management scheme for energy holes reduction in wireless sensor network*”, *Comput. Electr. Eng.*, vol. 48, pp. 343–357.
17. **Zhao X., (2008)**, “*Analysis of Strategies for Alleviating Energy Hole Problem in Wireless Sensor Networks*”, no. 2, pp. 359–362.
18. **Olariu S., Stojmenović I., (2006)**, “*Design guidelines for maximizing lifetime and avoiding energy holes in sensor networks with uniform distribution and uniform reporting*”, *Proc. - IEEE INFOCOM*, vol. 0, no. c.
19. **Azharuddin M., Jana P. K., (2016)**, “*Particle swarm optimization for maximizing the lifetime of wireless sensor network*”, *Comput. Electr. Eng.*, vol. 51, pp. 26–42.
20. **Jain A., Reddy B. V. R., (2014)**, “*Sink as Cluster head: An energy efficient clustering method for wireless sensor networks*”, *Data Min. Intell. Comput. (ICDMIC)*, 2014 Int. Conf., pp. 1–6.
21. **Yu J., Qi Y., Wang G., (2011)**, “*An energy-driven unequal clustering protocol for heterogeneous wireless sensor networks*”, *J. Control Theory Appl.*, vol. 9, no. 1, pp. 133–139.
22. **Gupta V., Pandey R., (2016)**, “*An improved energy aware distributed unequal clustering protocol for heterogeneous wireless sensor networks*”, *Eng. Sci. Technol. an Int. J.*, vol. 19, no. 2, pp. 1050–1058.
23. **Chiang T., (2014)**, “*Regional Energy Aware Clustering with Isolated Nodes in Wireless Sensor Networks*”, pp. 1829–1833.

24. **Far B. E., Alirezaee S., Makki S., (2014)**, “*Wireless Sensor Network Energy Minimization Using The Mobile Sink*”, pp. 1184–1188.
25. **Wang W., Srinivasan V., Chua K. C., (2005)**, “*Using mobile relays to prolong the lifetime of wireless sensor network*”, in *MobiCom '05: Proceedings of the 11th annual international conference on Mobile computing and networking*, pp. 270–283.
26. **Chanak P., Banerjee I., Sherratt R. S., (2016)**, “*Mobile sink based fault diagnosis scheme for wireless sensor networks*”, *J. Syst. Softw.*, vol. 119, pp. 45–57.
27. **Xiaobing W., Guihai C., (2007)**, “*Dual-Sink: Using mobile and static sinks for lifetime improvement in wireless sensor networks*”, *Proc. - Int. Conf. Comput. Commun. Networks, ICCCN*, pp. 1297–1302.
28. **Thangaraj M., Ponmalar P. P., (2011)**, “*A Survey on data aggregation techniques in wireless sensor networks*”, vol. 1, no. 3, pp. 36–42.
29. **Krishna M. B., Vashishta N., (2013)**, “*Energy efficient data aggregation techniques in wireless sensor networks*”, *Proc. - 5th Int. Conf. Comput. Intell. Commun. Networks, CICN 2013*, pp. 160–165.
30. **Awang A., Agarwal S., (2013)**, “*Data aggregation using RSSI for multihop Wireless Sensor Networks*”, *Int. Conf. Wirel. Commun. Signal Process.*, pp. 1–6.
31. **Guan L., (2008)**, “*Data Gathering Algorithm Based Load Balance for Wireless Sensor Networks*”, *Proc. 17th Int. Conf. Comput. Commun. Networks*, pp. 1–5, 2008.

32. **Bhardwaj M., Chandrakasan A. P., (2002)**, “*Bounding the lifetime of sensor networks via optimal role assignments*”, Proceedings.Twenty-First Annu. Jt. Conf. IEEE Comput. Commun. Soc., vol. 0, no. c, pp. 1587–1596.
33. **Yun Y., Xia Y., (2010)** “*A Method for Deciding Node Density in Non-Uniform Deployment of Wireless Sensor Networks*,” Pap. Under Conf. Submiss.
34. **Chatterjee P., Das N., (2014)**, “*Coverage constrained non-uniform node deployment in wireless sensor networks for load balancing*”, Appl. Innov. Mob. Comput., pp. 126–132.
35. **Tsai Y. R., Yang K. J., Yeh S. Y., (2008)**, “*Non-uniform node deployment for lifetime extension in large-scale randomly distributed wireless sensor networks*”, Proc. - Int. Conf. Adv. Inf. Netw. Appl. AINA, pp. 517–524.
36. **Yuan H., Liu W., (2011)**, “*Prolonging the Lifetime of Heterogeneous Wireless*,” pp. 3–6.
37. **B. Raton, (2008)**, “*Non-Uniform Sensor Deployment in Mobile Wireless Sensor Networks Florida Atlantic University Abstract Good sensor deployment is vital for wireless sensor networks (WSNs). To improve the initial deployment and to prolong network lifetime, one approach*”.
38. **Banerjee N., Corner M. D., Towsley D., Levine B. N., (2008)**, “*Relays, base stations, and meshes: enhancing mobile networks with infrastructure*”, in Proceedings of the 14th ACM international conference on Mobile computing and networking, pp. 81–91.
39. **Meghji M., Member S., Habibi D., Member S., (2011)**, “*Transmission Power Control in Multihop Wireless Sensor Networks*”, Icufn, pp. 25–30.

40. **Luo J., Xiang L.**, “*Prolong The Lifetime of Wireless Sensor Networks Through Mobility :A General Optimization Framework*”, Network, pp. 1–35.
41. **Cotuk H., Bicakci K., Tavli B., Uzun E., (2013)**, “*The Impact of Transmission Power Control Strategies on Lifetime of Wireless Sensor Networks*”, IEEE Trans. Comput., vol. 63, no. 11, pp. 1–1.
42. **Zen K., Jambli M. N., Suhaili S. M., Lenando H., Tully A., (2012)**, “*Transmission Power Control in Mobile Wireless Sensor Networks: Simulation-based Approach*”, IET Int. Conf. Wirel. Commun. pp. 095–095.
43. **Yang X. S., Koziel S., (2011)**, “*Computational optimization: An overview*,” Studies in Computational Intelligence, vol. 356. pp. 1–11.
44. **Civicioglu P., Besdok E., (2013)**, “*A conceptual comparison of the Cuckoo-search, particle swarm optimization, differential evolution and artificial bee colony algorithms*“, vol. 39, no. 4.
45. **Yang X. S., Koziel S., Leifsson L., (2013)**, “*Computational optimization, modeling and simulation: Recent trends and challenges*”, Procedia Comput. Sci., vol. 18, no. Coms, pp. 855–860.
46. **Biegler L. T., (2010)**, “*Introduction to Process Optimization*”, Nonlinear Program. Concepts, Algorithms, Appl. to Chem. Process., pp. 1–16.
47. **J. Nocedal and S. J. Wright, (2006)**, “*Numerical optimization*”.
48. **Rothlauf F., (2011)**, “*Design of Modern Heuristics*”.

49. **Jabbar S., Iram R., Minhas A. A., Shafi I., Khalid S., Ahmad M., (2013),** “*Intelligent optimization of wireless sensor networks through bio-inspired computing: Survey and future directions*”, International Journal of Distributed Sensor Networks.
50. **Gogu A., Nace D., Dilo A., Meratnia N., (2010)** “*Review of Optimization Problems in Wireless Sensor Networks*”.
51. **Adnan M. A., Abdur Razzaque M., Ahmed I., Isnin I. F., (2013),** “*Bio-mimic optimization strategies in wireless sensor networks: a survey.*”, Sensors (Basel)., vol. 14, no. 1, pp. 299–345.
52. **Chaudhry S. B., Hung V. C., Guha R. K., Stanley K. O., (2011),** “*Pareto-based evolutionary computational approach for wireless sensor placement*”, Eng. Appl. Artif. Intell., vol. 24, no. 3, pp. 409–425.
53. **Robichaud V., (2010),** “*An Introduction to GAMS I*”, Matrix, pp. 1–14.
54. **Geletu A., (2008),** “*GAMS - Modeling and Solving Optimization Problems*”, Dept. Oper. Res. Stochastic, Ilmenau Univ. Technol., no. April, pp. 1–43.
55. **Ozyer S. T., Tavli B., Koyuncu M., (2012),** “*Optimal energy efficient routing in wireless sensor networks with link asymmetry*”, Proc. Int. Conf. Commun., pp. 185–188.

APPENDICES A

CURRICULUM VITAE

PERSONAL INFORMATION

Surname, Name: Zaid Raad SABIR

Date and Place of Birth: 30 July 1983, Iraq

Marital Status: Married

Phone: +90 5395913467; 009647701248979

Email: zaid_4you@yahoo.com



EDUCATION

Degree	Institution	Year of Graduation
M.Sc.	Çankaya University Computer Engineering	2017
B.Sc.	College of Technology Kirkuk Software Engineering	2005
High School	Al_Waleed High School Scientific Section	2000

WORK EXPERIENCE

Year	Place	Enrollment
2009 - present	Tikrit Uni. Cisco Academy	Instructor
2008- present	Tikrit Uni. Computer Center	Network management
2006 -2008	North Oil Company	Engineering Management
2005 July	Al_ Maarefa Group	Trainer

FOREIN LANGUAGES

Arabic mother language, English, Turkish medium

HOBBIES

Sport, Social media, Travel, News